

MCASE+™ Slotted

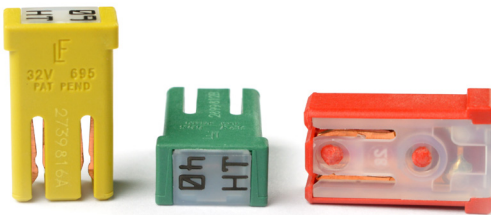

MCASE+™ Slotted HT

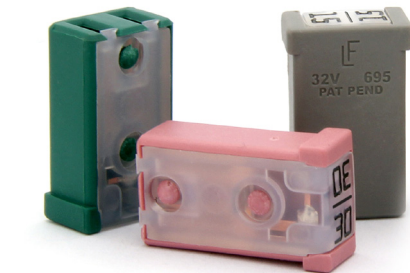

MCASE+™ Unslotted



MCASE+™ Unslotted HT

MCASE+™ Cartridge Fuses Rated 32V

MCASE+™ is a time delayed fuse designed to withstand inrush currents within a miniaturized footprint for optimal performance in minimal space. The Unslotted MCASE+™ cartridge style fuse can protect up to 40A with female terminals for 2.8 mm male terminals. The Slotted MCASE+™ Fuse is rated up to 60A and can mate with 6.3mm male terminals or even mount performance in minimal space directly onto a busbar. MCASE+ High Temperature (HT) have a lower voltage drop and are designed to operate with a lower temperature rise in harsher environmental applications.

Specification

Voltage Rating	32VDC
Interrupting Rating:	1000 @ 32VDC
Operating Temperature Range:	-40°C to +125°C
Housing Material:	PPA-GF33 (U.L. 94 Flammability rating - HB)
Cover Material:	PA66 (U.L. 94 Flammability rating - V2)
Net Weight Per Fuse:	1.15g ±10%
Fuse Insertion Force:	50N (11.2 lb) - Typical
Extraction Force:	4N Min. (0.9 lb) / 24.5N Max (5.5 lb) - Single Terminal
Conforms to:	SAE 2741 and ISO 8820-4 in reference to electrical, mechanical and environmental performance requirements.

RoHS

Ordering Information

Part Number	Type	Package Size
0695xxx.PXPS	Slotted	2000
0695xxx.PXPS-HT	Slotted	2000
0695xxx.PXP	Unslotted	2000
0695xxx.PXP-HT	Unslotted	2000

Time-Current Characteristics

% of Rating	Opening Time Min / Max (s)
110	100 hrs / ∞
135	60 / 1800
200	2 / 60
350	0.2 / 7
600	0.04 / 1

Ratings

Part Number	Type	Current Rating (A)	Housing Material Color	Wire Size (mm ²)	Typ. Voltage Drop (mV)	Cold Resistance (mΩ)	Melting I ² t (A ² s)
0695015.PXPS	Slotted	15	Grey	1.25	97	4.8	294
0695020.PXPS	Slotted	20	Blue	1.25	100	3.4	565
0695025.PXPS	Slotted	25	Yellow	2	99	2.5	1369
0695030.PXPS	Slotted	30	Pink	2	112	1.8	1032
0695040.PXPS	Slotted	40	Green	3	107	1.1	1439
0695050.PXPS	Slotted	50	Red	5	109	0.77	3829
0695060.PXPS	Slotted	60	Yellow	5	102	0.54	8026
0695040.PXPS-HT	Slotted	40	Green	3	111	0.89	2487
0695050.PXPS-HT	Slotted	50	Red	5	74	0.64	5718
0695060.PXPS-HT	Slotted	60	Yellow	5	90	0.46	13074
0695015.PXP	Unslotted	15	Grey	1.25	97	4.8	309
0695020.PXP	Unslotted	20	Blue	1.25	106	3.4	596
0695025.PXP	Unslotted	25	Yellow	2	114	2.5	1230
0695030.PXP	Unslotted	30	Pink	2	96	1.8	1041
0695040.PXP	Unslotted	40	Green	3	101	1	1688
0695040.PXP-HT	Unslotted	40	Green	3	109	0.89	2519

* The performance of the male terminal is critical to ensuring the fuse will function as designed. The current carrying capability of the mating terminal must be verified to ensure proper system operation.

** Melting I²t description: To determine the I²t value for very short overcurrents (ms) in the adiabatic zone, the current from the breaking capacity test is used.

The I²t value is calculated from the breaking capacity tests by using the current time profile before the arcing occurs.

REV08312020

Littelfuse products are not designed for, and shall not be used for, any purpose (including, without limitation, automotive, military, aerospace, medical, life-saving, life-sustaining or nuclear facility applications, devices intended for surgical implant into the body, or any other application in which the failure or lack of desired operation of the product may result in personal injury, death, or property damage) other than those expressly set forth in applicable Littelfuse product documentation. Warranties granted by Littelfuse shall be deemed void for products used for any purpose not expressly set forth in applicable Littelfuse documentation. Littelfuse shall not be liable for any claims or damages arising out of products used in applications not expressly intended by Littelfuse as set forth in applicable Littelfuse documentation. The sale and use of Littelfuse products is subject to Littelfuse Terms and Conditions of Sale, unless otherwise agreed by Littelfuse.

Cartridge Fuses

MCASE+™ Cartridge Fuses Rated 32V

The performance of the male terminal is critical to ensuring the fuse will function as designed. The current carrying capability of the mating terminal must be verified to ensure proper system operation. Fixture Test Set Up Refer To ISO 8820 4 (Plated Mating Tab Terminals). Please contact us for the details of Test Set Up Definition.

Dimensions

Dimensions in mm

MCASE+™ Slotted

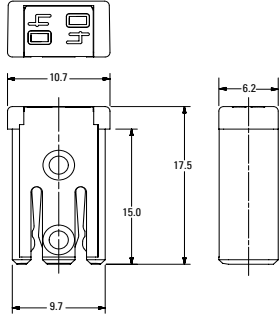

Slotted Recommended Mating Cavity

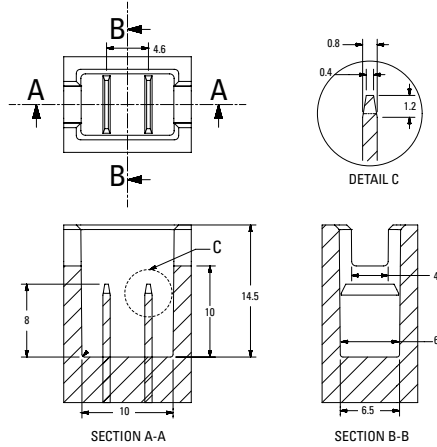

Time-Current Characteristic Curves

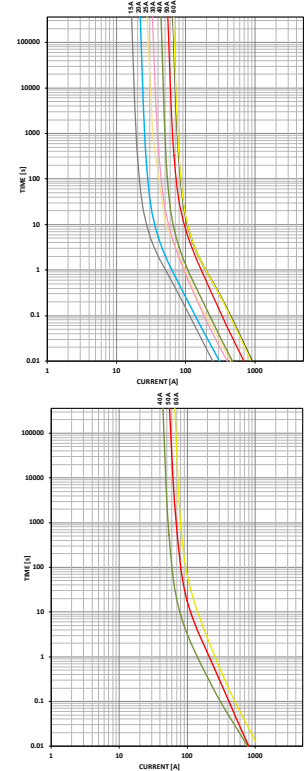

MCASE+™ Slotted HT

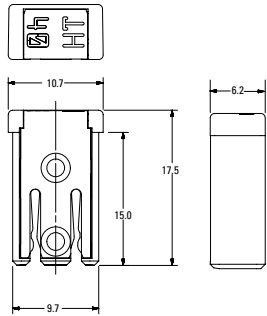

MCASE+™ Unslotted

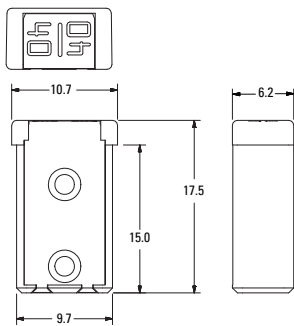

Unslotted Recommended Mating Cavity

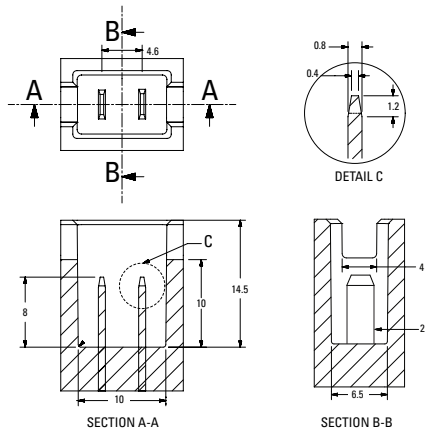

Time-Current Characteristic Curves

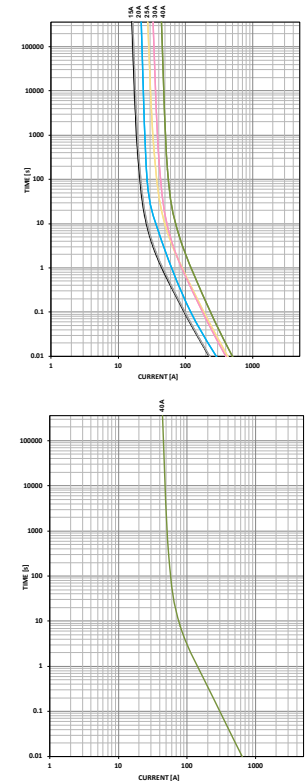

MCASE+™ Unslotted HT

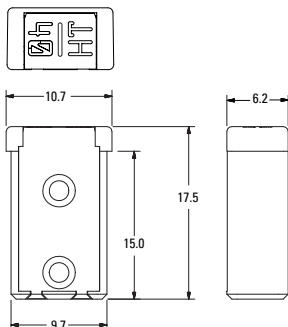

Recommended MCASE Fuse Puller
MATERIAL NUMBER 00970054XPA

REV08312020

Littelfuse products are not designed for, and shall not be used for, any purpose (including, without limitation, automotive, military, aerospace, medical, life-saving, life-sustaining or nuclear facility applications, devices intended for surgical implant into the body, or any other application in which the failure or lack of desired operation of the product may result in personal injury, death, or property damage) other than those expressly set forth in applicable Littelfuse product documentation. Warranties granted by Littelfuse shall be deemed void for products used for any purpose not expressly set forth in applicable Littelfuse documentation. Littelfuse shall not be liable for any claims or damages arising out of products used in applications not expressly intended by Littelfuse as set forth in applicable Littelfuse documentation. The sale and use of Littelfuse products is subject to Littelfuse Terms and Conditions of Sale, unless otherwise agreed by Littelfuse.

MCASE+™ Cartridge Fuses Rated 32V

Typical Derating Of Fuse Melting Element

Temperature Security Margin is 20%
 Fixture Test Set Up Refer To ISO 8820-4 With (Plated Mating Tab Terminals)
 Please contact us for the details of Test Set Up Definition

MCASE+™ Slotted

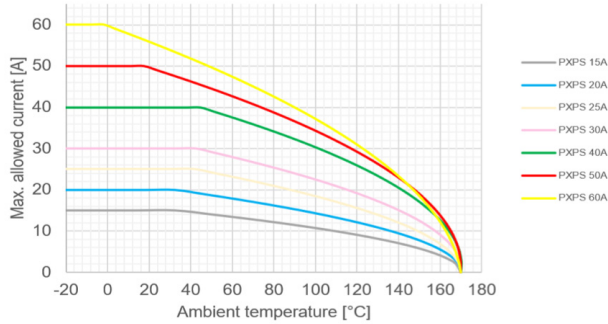

Temperature Table

	max. allowed current load [A] at ambient temperature)							
	-20°C	0°C	20°C	65°C	85°C	95°C	105°C	125°C
15A	15	15	15	13	12	11	10	9
20A	20	20	20	18	16	15	14	12
25A	25	25	25	23	20	19	18	15
30A	30	30	30	27	25	23	22	18
40A	40	40	40	37	33	31	29	25
50A	50	50	50	42	38	35	33	28
60A	60	60	56	46	41	39	36	29

MCASE+™ Slotted HT

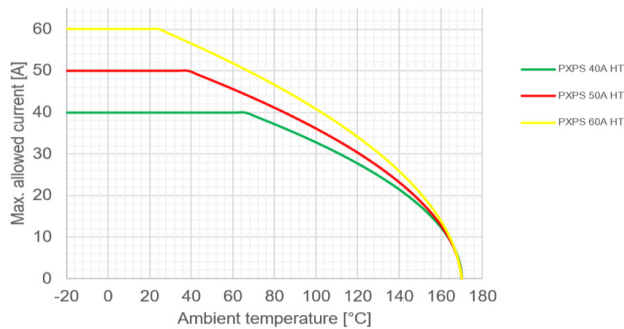

Temperature Table

	max. allowed current load [A] at ambient temperature)							
	-20°C	0°C	20°C	65°C	85°C	95°C	105°C	125°C
40A HT	40	40	40	40	36	34	32	26
50A HT	50	50	50	45	40	37	35	29
60A HT	60	60	60	51	45	42	39	32

MCASE+™ Unslotted

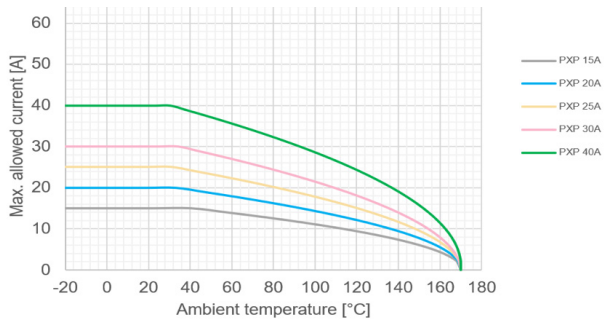

Temperature Table

	max. allowed current load [A] at ambient temperature)							
	-20°C	0°C	20°C	65°C	85°C	95°C	105°C	125°C
15A	15	15	15	14	12	11	11	9
20A	20	20	20	18	16	15	14	12
25A	25	25	25	22	20	18	17	14
30A	30	30	30	26	24	22	21	17
40A	40	40	40	35	31	30	28	23

MCASE+™ Unslotted HT

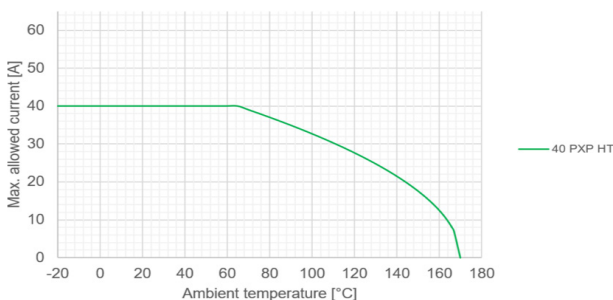

Temperature Table

	max. allowed current load [A] at ambient temperature)							
	-20°C	0°C	20°C	65°C	85°C	95°C	105°C	125°C
40A HT	40	40	40	40	36	34	32	26

REV08312020

Littelfuse products are not designed for, and shall not be used for, any purpose (including, without limitation, automotive, military, aerospace, medical, life-saving, life-sustaining or nuclear facility applications, devices intended for surgical implant into the body, or any other application in which the failure or lack of desired operation of the product may result in personal injury, death, or property damage) other than those expressly set forth in applicable Littelfuse product documentation. Warranties granted by Littelfuse shall be deemed void for products used for any purpose not expressly set forth in applicable Littelfuse documentation. Littelfuse shall not be liable for any claims or damages arising out of products used in applications not expressly intended by Littelfuse as set forth in applicable Littelfuse documentation. The sale and use of Littelfuse products is subject to Littelfuse Terms and Conditions of Sale, unless otherwise agreed by Littelfuse.