



Aluminum electrolytic capacitors

Capacitors with 4-pin snap-in terminals and solder pins

Series/Type: B43516, B43526

Date: December 2019

Long-life grade capacitors

Applications

- Frequency converters
- Solar inverters
- Uninterruptible power supplies
- Professional power supplies
- Medical appliances
- Not for automotive applications unless otherwise specified



B43516

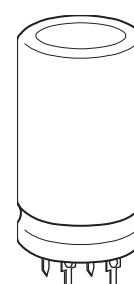

B43526

Features

- Long useful life
- High reliability and high ripple current capability
- High volumetric efficiency
- Many different case sizes
- Pinning ensures correct insertion
- RoHS-compatible

Construction

- Charge/discharge-proof, polar
- Aluminum case, fully insulated with PET
- Version with additional PET insulation cap on terminal side and PVC insulation available for insulating the capacitor from the PCB (B43516 only)
- Version with PVC insulation available upon request
- Overload protection by safety vent on the case wall

Terminals

- 4-pin snap-in terminals (6.3 mm and 4.5 mm length)
- Solder pin mounting on printed circuit boards, pins fit standardized spacings on PCB

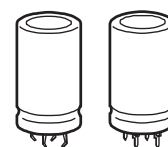
Specifications and characteristics in brief

Rated voltage V_R	400 ... 450 V DC										
Surge voltage V_S	$1.1 \cdot V_R$										
Rated capacitance C_R	270 ... 1800 μ F										
Capacitance tolerance	$\pm 20\%$ \triangleq M										
Dissipation factor $\tan \delta$ (20 °C, 120 Hz)	$V_R = 400$ V DC: $\tan \delta \leq 0.15$ $V_R > 400$ V DC: $\tan \delta \leq 0.20$										
Leakage current I_{leak} (5 min, 20 °C)	$I_{leak} \leq 0.3 \mu A \cdot \left(\frac{C_R}{\mu F} \cdot \frac{V_R}{V} \right)^{0.7} + 4 \mu A$										
Self-inductance ESL	Approx. 20 nH										
Useful life ¹⁾ 105 °C; V_R ; $I_{AC,R}$	> 3000 h	Requirements: $ \Delta C/C \leq 20\%$ of initial value $\tan \delta \leq 2$ times initial specified limit $I_{leak} \leq$ initial specified limit									
Voltage endurance test 105 °C; V_R	2000 h	Post test requirements: $ \Delta C/C \leq 10\%$ of initial value $\tan \delta \leq 1.3$ times initial specified limit $I_{leak} \leq$ initial specified limit									
Vibration resistance test	To IEC 60068-2-6, test Fc: Frequency range 10 ... 55 Hz, displacement amplitude 0.35 mm, acceleration max. 5 g, duration 3×2 h. Capacitor mounted by its body which is rigidly clamped to the work surface.										
Characteristics at low temperature	Max. impedance ratio at 100 Hz	<table border="1"> <thead> <tr> <th>V_R</th> <th>400 V</th> <th>> 400 V</th> </tr> </thead> <tbody> <tr> <td>$Z_{-25\text{ °C}} / Z_{20\text{ °C}}$</td> <td>3</td> <td>5</td> </tr> <tr> <td>$Z_{-40\text{ °C}} / Z_{20\text{ °C}}$</td> <td>7</td> <td>10</td> </tr> </tbody> </table>	V_R	400 V	> 400 V	$Z_{-25\text{ °C}} / Z_{20\text{ °C}}$	3	5	$Z_{-40\text{ °C}} / Z_{20\text{ °C}}$	7	10
V_R	400 V	> 400 V									
$Z_{-25\text{ °C}} / Z_{20\text{ °C}}$	3	5									
$Z_{-40\text{ °C}} / Z_{20\text{ °C}}$	7	10									
IEC climatic category	To IEC 60068-1: 40/105/56 (–40 °C/+105 °C/56 days damp heat test)										
Sectional specification	IEC 60384-4										

1) Refer to chapter "General technical information, 5 Useful life" on how to interpret useful life.

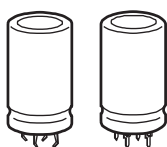

B43516, B43526

105 °C

Dimensional drawings

B43516, 4-pin snap-in terminals, standard insulation (PET)

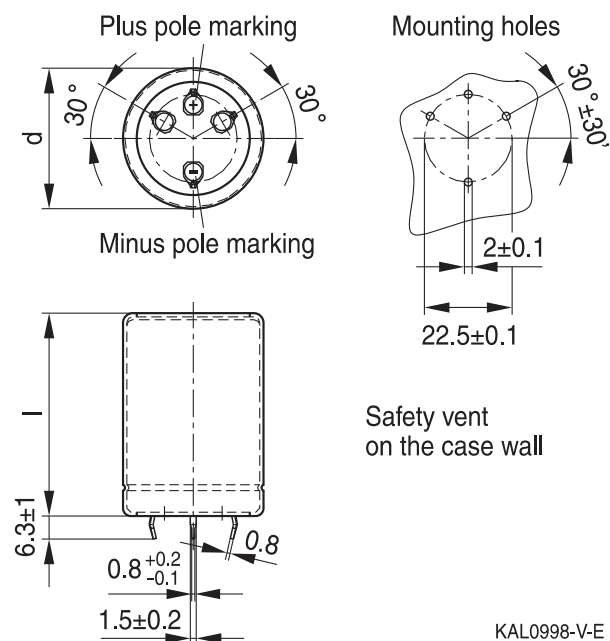

Standard snap-in terminals:

length (6.3 ± 1) mm.

Also available with length of (4.5 – 1) mm.

All pin holes must be drilled into the PC-board, since the unconnected pins serve as mountings. These pins must be soldered to insulated pads or pads with the same potential as the negative pole.

Dimensions (mm)		Approx. weight (g)	Packing units (pcs.)
d +1	l ±2		
35	40	51	60
35	45	57	60
35	50	63	60
35	55	70	36
35	60	76	36
35	65	82	36
35	70	88	36
35	75	95	36
35	80	101	36
35	85	107	36
35	95	120	36
35	100	126	36
40	40	71	33
40	45	80	33
40	50	89	33
40	55	98	33
40	60	107	33
40	65	116	33
40	70	125	33
40	75	134	33
40	80	143	33
40	90	161	33
40	95	170	33
45	40	95	28
45	45	108	28
45	50	120	28
45	55	132	28
45	60	143	28
45	70	166	28
45	75	178	28
45	80	190	28
45	90	214	28
45	95	226	28

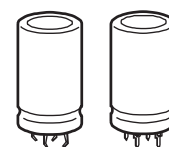
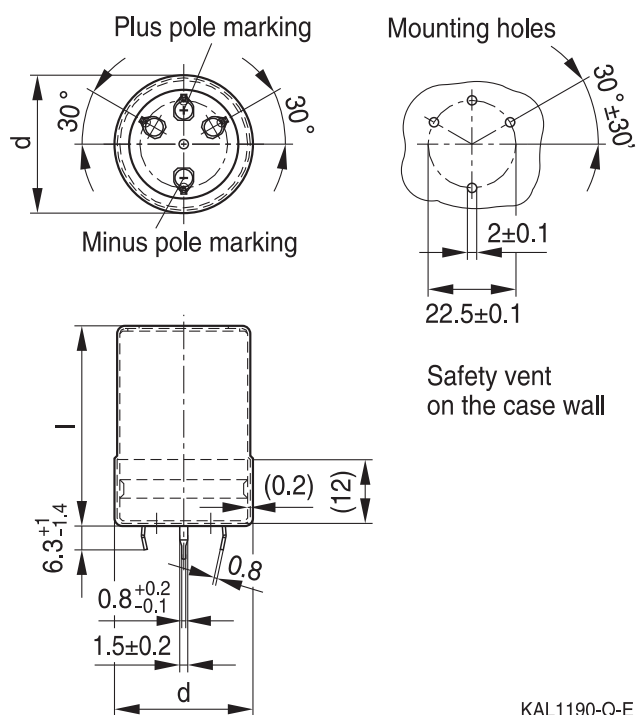

B43516, 4-pin snap-in terminals, PVC insulation and PET insulation cap on terminal side

Standard snap-in terminals:

length (6.3 +1/-1.4) mm. Also available with length of (4.5 -1.4) mm. PET insulation cap is positioned under the insulation sleeve.

All pin holes must be drilled into the PC-board, since the unconnected pins serve as mountings. These pins must be soldered to insulated pads or pads with the same potential as the negative pole.

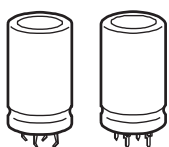
Dimensions (mm)		Approx. weight (g)	Packing units (pcs.)
d +1	l ±2		
35	40	51	60
35	45	57	60
35	50	63	60
35	55	70	36
35	60	76	36
35	65	82	36
35	70	88	36
35	75	95	36
35	80	101	36
35	85	107	36
35	95	120	36
35	100	126	36
40	40	71	33
40	45	80	33
40	50	89	33
40	55	98	33
40	60	107	33
40	65	116	33
40	70	125	33
40	75	134	33
40	80	143	33
40	90	161	33
40	95	170	33
45	40	95	28
45	45	108	28
45	50	120	28
45	55	132	28
45	60	143	28
45	70	166	28
45	75	178	28
45	80	190	28
45	90	214	28
45	95	226	28



B43516, B43526

105 °C

B43526, solder pins

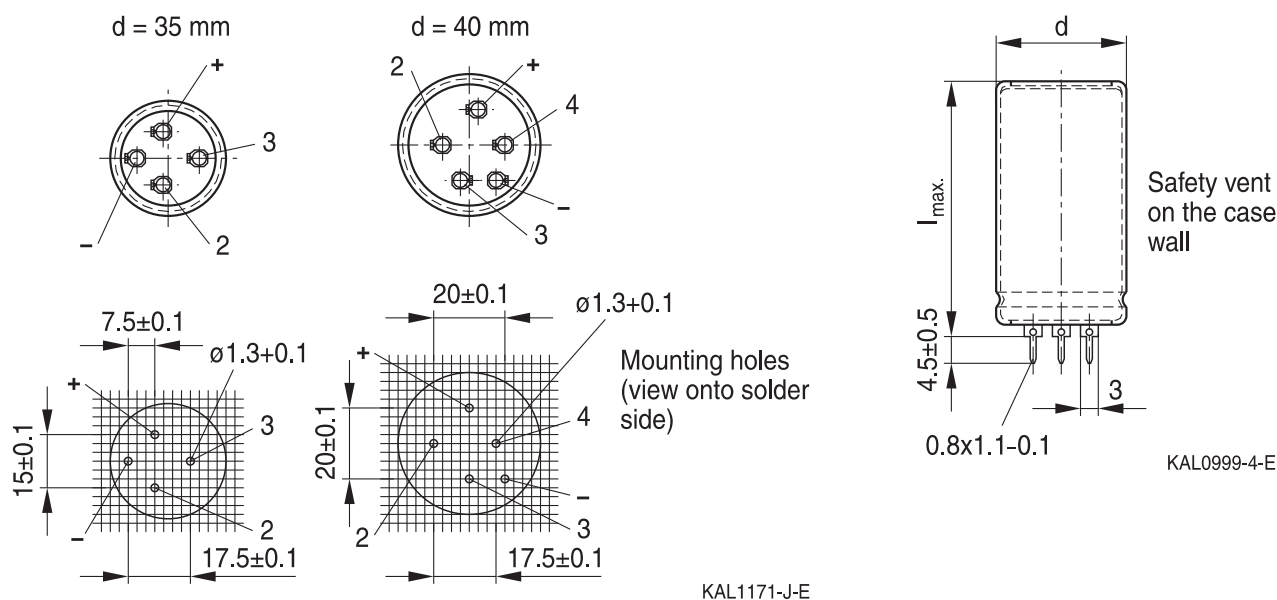

Pole markings: Plus: +; Minus: -

All pin holes must be drilled into the PC-board, since the unconnected pins serve as mountings. These pins must be soldered to insulated pads or pads with the same potential as the negative pole.

Dimensions (mm)		Approx. weight (g)	Packing units (pcs.)
d +1	l_{max}		
35	44	51	60
35	49	57	60
35	54	63	60
35	59	70	36
35	64	76	36
35	69	82	36
35	74	88	36
35	79	95	36
35	84	101	36
35	89	107	36
35	99	120	36
35	104	126	36

Dimensions (mm)		Approx. weight (g)	Packing units (pcs.)
d +1	l_{max}		
40	44	71	33
40	49	80	33
40	54	89	33
40	59	98	33
40	64	107	33
40	69	116	33
40	74	125	33
40	79	134	33
40	84	143	33
40	94	161	33
40	99	170	33

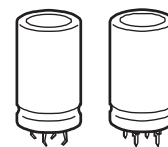

Packing of 4-pin snap-in terminal and solder pin capacitors



For ecological reasons the packing is pure cardboard.

Ordering codes for terminal styles and insulation features

Identification in 3rd block of ordering code

4-pin snap-in terminal capacitors

Terminal version	Insulation version	
	PET	PVC plus PET cap
Standard terminals 6.3 mm	M060	M080
Short terminals 4.5 mm	M067	M087

Ordering examples:

B43516A9188M067 } 4-pin snap-in capacitor with short terminals and PET insulation

B43516A9188M080 } 4-pin snap-in capacitor with standard terminals and PVC insulation with additional PET insulation cap on terminal side

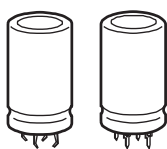

B43516, B43526

105 °C

Overview of available types

The capacitance and voltage ratings listed below are available in different case sizes upon request. Other voltage and capacitance ratings are also available upon request. Capacitors with solder pins are only available in 35 and 40 mm case diameters.

V_R (V DC)	400	420	450
	Case dimensions $d \times l$ (mm)		
C_R (μF)			
270			35 × 40
330	35 × 40	35 × 40	35 × 45
390	35 × 45	35 × 45 40 × 40	35 × 50 40 × 40
470	35 × 45 40 × 40	35 × 50 40 × 45	35 × 55 40 × 45
560	35 × 55 40 × 45	35 × 60 40 × 50	35 × 65 40 × 50 45 × 40
680	35 × 65 40 × 50 45 × 40	35 × 70 40 × 55 45 × 40	35 × 75 40 × 60 45 × 45
820	35 × 75 40 × 60 45 × 45	35 × 80 40 × 60 45 × 50	35 × 85 40 × 65 45 × 55
1000	35 × 85 40 × 65 45 × 50	35 × 95 40 × 70 45 × 55	35 × 100 40 × 80 45 × 60
1200	35 × 100 40 × 75 45 × 60	40 × 90 45 × 70	40 × 95 45 × 75
1500	40 × 95 45 × 70	45 × 80	45 × 90
1800	45 × 90	45 × 95	

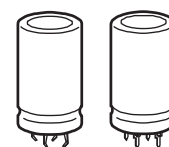
Technical data and ordering codes

C_R 100 Hz 20 °C μF	Case dimensions $d \times l$ mm	ESR_{typ} 100 Hz 20 °C m Ω	ESR_{typ} 300 Hz 60 °C m Ω	Z_{max} 10 kHz 20 °C m Ω	$I_{\text{AC,max}}$ 100 Hz 60 °C A	$I_{\text{AC,max}}$ 100 Hz 85 °C A	$I_{\text{AC,R}}$ 100 Hz 105 °C A	Ordering code (composition see below)
$V_R = 400 \text{ V DC}$								
330	35 × 40	230	70	330	4.68	3.48	1.78	B435*6A9337M0##
390	35 × 45	200	60	280	5.24	3.89	2.00	B435*6A9397M0##
470	35 × 45	170	50	250	5.97	4.43	2.27	B435*6A9477M0##
470	40 × 40	170	50	230	5.99	4.45	2.28	B435*6B9477M0##
560	35 × 55	140	40	200	6.70	4.98	2.55	B435*6A9567M0##
560	40 × 45	140	45	200	6.72	4.99	2.56	B435*6B9567M0##
680	35 × 65	110	34	160	7.71	5.74	2.94	B435*6A9687M0##
680	40 × 50	120	36	170	7.63	5.67	2.90	B435*6B9687M0##
680	45 × 40	120	40	170	7.58	5.62	2.88	B43516C9687M0##
820	35 × 75	95	28	140	8.86	6.59	3.38	B435*6A9827M0##
820	40 × 60	95	30	140	8.71	6.48	3.32	B435*6B9827M0##
820	45 × 45	100	34	140	8.54	6.34	3.25	B43516C9827M0##
1000	35 × 85	80	24	110	10.3	7.66	3.93	B435*6A9108M0##
1000	40 × 65	80	26	120	9.97	7.40	3.79	B435*6B9108M0##
1000	45 × 50	80	28	120	9.68	7.19	3.68	B43516C9108M0##
1200	35 × 100	65	20	90	11.9	8.85	4.54	B435*6A9128M0##
1200	40 × 75	65	22	95	11.3	8.46	4.33	B435*6B9128M0##
1200	45 × 60	70	24	100	11.0	8.21	4.21	B43516C9128M0##
1500	40 × 95	50	17	75	13.7	10.2	5.25	B435*6A9158M0##
1500	45 × 70	55	19	80	13.1	9.75	5.00	B43516B9158M0##
1800	45 × 90	45	15	65	15.1	11.2	5.77	B43516A9188M0##

Capacitors with solder pins are only available in 35 and 40 mm case diameters.

Composition of ordering code

* = Terminal type

1 = 4-pin snap-in terminals

2 = solder pin

= Terminal style and insulation feature

60 = solder pin or 4-pin snap-in standard terminals and PET insulation

67 = 4-pin snap-in short terminals and PET insulation

80 = 4-pin snap-in standard terminals and PVC insulation with additional PET insulation cap on terminal side

87 = 4-pin snap-in short terminals and PVC insulation with additional PET insulation cap on terminal side

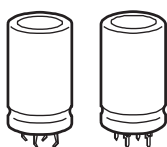

B43516, B43526

105 °C

Technical data and ordering codes

C_R 100 Hz 20 °C μF	Case dimensions $d \times l$ mm	ESR_{typ} 100 Hz 20 °C m Ω	ESR_{typ} 300 Hz 60 °C m Ω	Z_{max} 10 kHz 20 °C m Ω	$I_{\text{AC,max}}$ 100 Hz 60 °C A	$I_{\text{AC,max}}$ 100 Hz 85 °C A	$I_{\text{AC,R}}$ 100 Hz 105 °C A	Ordering code (composition see below)
$V_R = 420 \text{ V DC}$								
330	35 × 40	320	85	480	4.54	3.37	1.73	B435*6A0337M0##
390	35 × 45	270	70	410	5.09	3.78	1.94	B435*6A0397M0##
390	40 × 40	270	75	410	5.21	3.87	1.98	B435*6B0397M0##
470	35 × 50	220	60	340	5.78	4.30	2.20	B435*6A0477M0##
470	40 × 45	230	60	340	5.87	4.37	2.24	B435*6B0477M0##
560	35 × 60	190	50	290	6.56	4.88	2.50	B435*6A0567M0##
560	40 × 50	190	50	290	6.59	4.90	2.51	B435*6B0567M0##
680	35 × 70	160	40	240	7.56	5.63	2.89	B435*6A0687M0##
680	40 × 55	160	45	240	7.49	5.57	2.85	B435*6B0687M0##
680	45 × 40	160	45	250	7.35	5.45	2.79	B43516C0687M0##
820	35 × 80	130	34	200	8.70	6.48	3.32	B435*6A0827M0##
820	40 × 60	130	36	200	8.51	6.32	3.24	B435*6B0827M0##
820	45 × 50	130	38	200	8.45	6.28	3.21	B43516C0827M0##
1000	35 × 95	110	28	160	10.1	7.56	3.88	B435*6A0108M0##
1000	40 × 70	110	30	170	9.81	7.29	3.73	B435*6B0108M0##
1000	45 × 55	110	32	170	9.59	7.12	3.65	B43516C0108M0##
1200	40 × 90	85	24	130	11.5	8.56	4.39	B435*6A0128M0##
1200	45 × 70	85	26	130	11.1	8.31	4.26	B43516B0128M0##
1500	45 × 80	70	22	110	13.0	9.71	4.97	B43516A0158M0##
1800	45 × 95	60	18	90	15.0	11.1	5.72	B43516A0188M0##

Capacitors with solder pins are only available in 35 and 40 mm case diameters.

Composition of ordering code

* = Terminal type

- 1 = 4-pin snap-in terminals
- 2 = solder pin

= Terminal style and insulation feature

- 60 = solder pin or 4-pin snap-in standard terminals and PET insulation
- 67 = 4-pin snap-in short terminals and PET insulation
- 80 = 4-pin snap-in standard terminals and PVC insulation with additional PET insulation cap on terminal side
- 87 = 4-pin snap-in short terminals and PVC insulation with additional PET insulation cap on terminal side

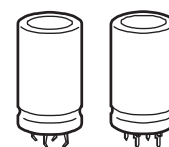
Technical data and ordering codes

C_R 100 Hz 20 °C μF	Case dimensions $d \times l$ mm	ESR_{typ} 100 Hz 20 °C m Ω	ESR_{typ} 300 Hz 60 °C m Ω	Z_{max} 10 kHz 20 °C m Ω	$I_{\text{AC,max}}$ 100 Hz 60 °C A	$I_{\text{AC,max}}$ 100 Hz 85 °C A	$I_{\text{AC,R}}$ 100 Hz 105 °C A	Ordering code (composition see below)
$V_R = 450 \text{ V DC}$								
270	35 × 40	360	95	520	4.06	2.97	1.57	B435*6A5277M0##
330	35 × 45	290	75	430	4.64	3.39	1.80	B435*6A5337M0##
390	35 × 50	250	65	360	5.20	3.81	2.02	B435*6A5397M0##
390	40 × 40	250	70	370	5.26	3.84	2.03	B435*6B5397M0##
470	35 × 55	200	55	300	5.92	4.33	2.30	B435*6A5477M0##
470	40 × 45	210	55	310	5.94	4.34	2.30	B435*6B5477M0##
560	35 × 65	170	45	260	6.73	4.93	2.61	B435*6A5567M0##
560	40 × 50	170	50	260	6.68	4.88	2.59	B435*6B5567M0##
560	45 × 40	180	50	260	6.66	4.86	2.58	B43516C5567M0##
680	35 × 75	140	38	210	7.78	5.69	3.02	B435*6A5687M0##
680	40 × 60	140	40	210	7.67	5.61	2.97	B435*6B5687M0##
680	45 × 45	150	45	220	7.55	5.51	2.92	B43516C5687M0##
820	35 × 85	120	32	180	8.98	6.57	3.49	B435*6A5827M0##
820	40 × 65	120	34	180	8.73	6.38	3.38	B435*6B5827M0##
820	45 × 55	120	36	180	8.64	6.32	3.35	B43516C5827M0##
1000	35 × 100	95	26	150	10.5	7.69	4.08	B435*6A5108M0##
1000	40 × 80	100	28	150	10.1	7.40	3.93	B435*6B5108M0##
1000	45 × 60	100	30	150	9.83	7.18	3.81	B43516C5108M0##
1200	40 × 95	80	22	120	12.1	9.00	4.61	B435*6A5128M0##
1200	45 × 75	80	24	120	11.7	8.69	4.45	B43516B5128M0##
1500	45 × 90	65	19	95	13.7	10.2	5.25	B43516A5158M0##

Capacitors with solder pins are only available in 35 and 40 mm case diameters.

Composition of ordering code

* = Terminal type

1 = 4-pin snap-in terminals

2 = solder pin

= Terminal style and insulation feature

60 = solder pin or 4-pin snap-in standard terminals and PET insulation

67 = 4-pin snap-in short terminals and PET insulation

80 = 4-pin snap-in standard terminals and PVC insulation with additional PET insulation cap on terminal side

87 = 4-pin snap-in short terminals and PVC insulation with additional PET insulation cap on terminal side

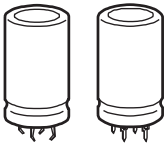

B43516, B43526

105 °C

Useful life¹⁾

For useful life calculations, please use our web-based "AlCap Useful Life Calculation Tool", which can be found on the Internet under the following link:

www.tdk-electronics.tdk.com/alcap

The AlCap Useful Life Calculation Tool provides calculations of useful life as well as additional data for selected capacitor types under operating conditions defined by the user.

In addition, it is possible to calculate useful life expectancies based on temperatures measured by the user in the application.

Frequency characteristics of ESR

Typical behavior

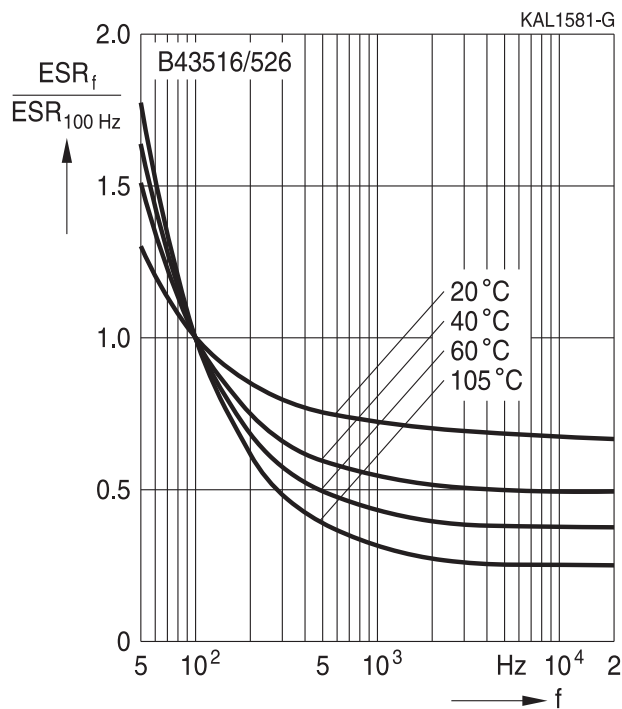

Impedance Z versus frequency f

Typical behavior at 20 °C

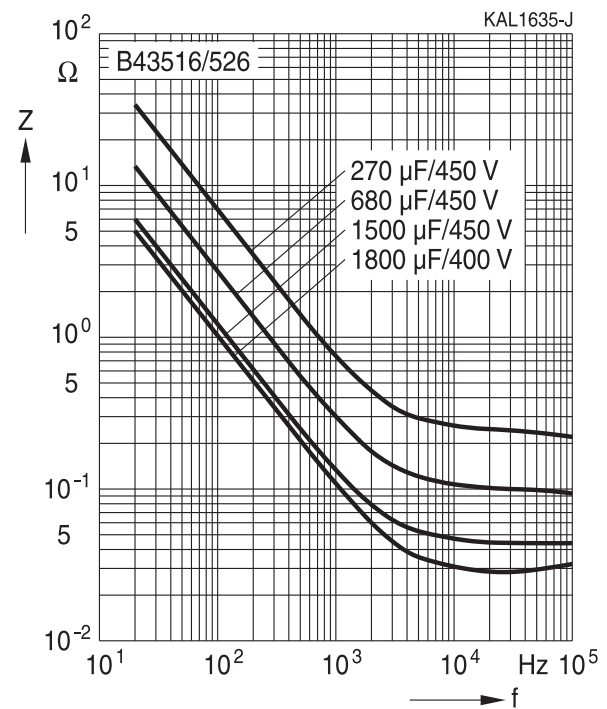

1) Refer to chapter "General technical information, 5 Useful life" on how to interpret useful life.

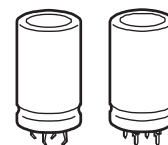

Cautions and warnings

Personal safety

The electrolytes used have been optimized both with a view to the intended application and with regard to health and environmental compatibility. They do not contain any solvents that are detrimental to health, e.g. dimethyl formamide (DMF) or dimethyl acetamide (DMAC). Furthermore, some of the high-voltage electrolytes used are self-extinguishing.

As far as possible, we do not use any dangerous chemicals or compounds to produce operating electrolytes, although in exceptional cases, such materials must be used in order to achieve specific physical and electrical properties because no alternative materials are currently known. We do, however, restrict the amount of dangerous materials used in our products to an absolute minimum.

Materials and chemicals used in our aluminum electrolytic capacitors are continuously adapted in compliance with the TDK Electronics Corporate Environmental Policy and the latest EU regulations and guidelines such as RoHS, REACH/SVHC, GADSL, and ELV.

MDS (Material Data Sheets) are available on our website for all types listed in the data book. MDS for customer specific capacitors are available upon request.

MSDS (Material Safety Data Sheets) are available for our electrolytes upon request.

Nevertheless, the following rules should be observed when handling aluminum electrolytic capacitors: No electrolyte should come into contact with eyes or skin. If electrolyte does come into contact with the skin, wash the affected areas immediately with running water. If the eyes are affected, rinse them for 10 minutes with plenty of water. If symptoms persist, seek medical treatment. Avoid inhaling electrolyte vapor or mists. Workplaces and other affected areas should be well ventilated. Clothing that has been contaminated by electrolyte must be changed and rinsed in water.

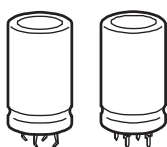

B43516, B43526

105 °C

Product safety

The table below summarizes the safety instructions that must be observed without fail. A detailed description can be found in the relevant sections of separate file chapter "General technical information".

Topic	Safety information	Reference chapter "General technical information"
Polarity	Make sure that polar capacitors are connected with the right polarity.	1 "Basic construction of aluminum electrolytic capacitors"
Reverse voltage	Voltages of opposite polarity should be prevented by connecting a diode.	3.1.6 "Reverse voltage"
Mounting position of screw-terminal capacitors	Screw terminal capacitors must not be mounted with terminals facing down unless otherwise specified.	11.1. "Mounting positions of capacitors with screw terminals"
Robustness of terminals	The following maximum tightening torques must not be exceeded when connecting screw terminals: M5: 2.5 Nm M6: 4.0 Nm	11.3 "Mounting torques"
Mounting of single-ended capacitors	The internal structure of single-ended capacitors might be damaged if excessive force is applied to the lead wires. Avoid any compressive, tensile or flexural stress. Do not move the capacitor after soldering to PC board. Do not pick up the PC board by the soldered capacitor. Do not insert the capacitor on the PC board with a hole space different to the lead space specified.	11.4 "Mounting considerations for single-ended capacitors"
Soldering	Do not exceed the specified time or temperature limits during soldering.	11.5 "Soldering"
Soldering, cleaning agents	Do not allow halogenated hydrocarbons to come into contact with aluminum electrolytic capacitors.	11.6 "Cleaning agents"
Upper category temperature	Do not exceed the upper category temperature.	7.2 "Maximum permissible operating temperature"
Passive flammability	Avoid external energy, e.g. fire.	8.1 "Passive flammability"

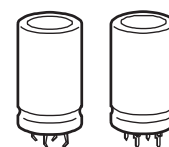

Topic	Safety information	Reference chapter "General technical information"
Active flammability	Avoid overload of the capacitors.	8.2 "Active flammability"
Maintenance	Make periodic inspections of the capacitors. Before the inspection, make sure that the power supply is turned off and carefully discharge the capacitors. Do not apply excessive mechanical stress to the capacitor terminals when mounting.	10 "Maintenance"
Storage	Do not store capacitors at high temperatures or high humidity. Capacitors should be stored at +5 to +35 °C and a relative humidity of ≤ 75%.	7.3 "Shelf life and storage conditions"
		Reference chapter "Capacitors with screw terminals"
Breakdown strength of insulating sleeves	Do not damage the insulating sleeve, especially when ring clips are used for mounting.	"Screw terminals – accessories"

Display of ordering codes for TDK Electronics products

The ordering code for one and the same product can be represented differently in data sheets, data books, other publications, on the company website, or in order-related documents such as shipping notes, order confirmations and product labels. The varying representations of the ordering codes are due to different processes employed and do not affect the specifications of the respective products.

Detailed information can be found on the Internet under www.tdk-electronics.tdk.com/orderingcodes.

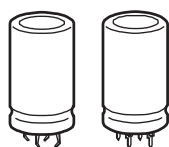

B43516, B43526

105 °C

Symbols and terms

Symbol	English	German
C	Capacitance	Kapazität
C_R	Rated capacitance	Nennkapazität
C_S	Series capacitance	Serienkapazität
$C_{S,T}$	Series capacitance at temperature T	Serienkapazität bei Temperatur T
C_f	Capacitance at frequency f	Kapazität bei Frequenz f
d	Case diameter, nominal dimension	Gehäusedurchmesser, Nennmaß
d_{max}	Maximum case diameter	Maximaler Gehäusedurchmesser
ESL	Self-inductance	Eigeninduktivität
ESR	Equivalent series resistance	Ersatzserienwiderstand
ESR_f	Equivalent series resistance at frequency f	Ersatzserienwiderstand bei Frequenz f
ESR_T	Equivalent series resistance at temperature T	Ersatzserienwiderstand bei Temperatur T
f	Frequency	Frequenz
I	Current	Strom
I_{AC}	Alternating current (ripple current)	Wechselstrom
$I_{AC,RMS}$	Root-mean-square value of alternating current	Wechselstrom, Effektivwert
$I_{AC,f}$	Ripple current at frequency f	Wechselstrom bei Frequenz f
$I_{AC,max}$	Maximum permissible ripple current	Maximal zulässiger Wechselstrom
$I_{AC,R}$	Rated ripple current	Nennwechselstrom
I_{leak}	Leakage current	Reststrom
$I_{leak,op}$	Operating leakage current	Betriebsreststrom
l	Case length, nominal dimension	Gehäuselänge, Nennmaß
l_{max}	Maximum case length (without terminals and mounting stud)	Maximale Gehäuselänge (ohne Anschlüsse und Gewindebolzen)
R	Resistance	Widerstand
R_{ins}	Insulation resistance	Isolationswiderstand
R_{symm}	Balancing resistance	Symmetrierwiderstand
T	Temperature	Temperatur
ΔT	Temperature difference	Temperaturdifferenz
T_A	Ambient temperature	Umgebungstemperatur
T_C	Case temperature	Gehäusetemperatur
T_B	Capacitor base temperature	Temperatur des Gehäusebodens
t	Time	Zeit
Δt	Period	Zeitraum
t_b	Service life (operating hours)	Brauchbarkeitsdauer (Betriebszeit)

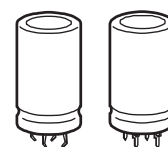

Symbol	English	German
V	Voltage	Spannung
V_F	Forming voltage	Formierspannung
V_{op}	Operating voltage	Betriebsspannung
V_R	Rated voltage, DC voltage	Nennspannung, Gleichspannung
V_S	Surge voltage	Spitzenspannung
X_C	Capacitive reactance	Kapazitiver Blindwiderstand
X_L	Inductive reactance	Induktiver Blindwiderstand
Z	Impedance	Scheinwiderstand
Z_T	Impedance at temperature T	Scheinwiderstand bei Temperatur T
$\tan \delta$	Dissipation factor	Verlustfaktor
λ	Failure rate	Ausfallrate
ϵ_0	Absolute permittivity	Elektrische Feldkonstante
ϵ_r	Relative permittivity	Dielektrizitätszahl
ω	Angular velocity; $2 \cdot \pi \cdot f$	Kreisfrequenz; $2 \cdot \pi \cdot f$

Note

All dimensions are given in mm.

Important notes

The following applies to all products named in this publication:

1. Some parts of this publication contain **statements about the suitability of our products for certain areas of application**. These statements are based on our knowledge of typical requirements that are often placed on our products in the areas of application concerned. We nevertheless expressly point out **that such statements cannot be regarded as binding statements about the suitability of our products for a particular customer application**. As a rule, we are either unfamiliar with individual customer applications or less familiar with them than the customers themselves. For these reasons, it is always ultimately incumbent on the customer to check and decide whether a product with the properties described in the product specification is suitable for use in a particular customer application.
2. We also point out that **in individual cases, a malfunction of electronic components or failure before the end of their usual service life cannot be completely ruled out in the current state of the art, even if they are operated as specified**. In customer applications requiring a very high level of operational safety and especially in customer applications in which the malfunction or failure of an electronic component could endanger human life or health (e.g. in accident prevention or lifesaving systems), it must therefore be ensured by means of suitable design of the customer application or other action taken by the customer (e.g. installation of protective circuitry or redundancy) that no injury or damage is sustained by third parties in the event of malfunction or failure of an electronic component.
3. **The warnings, cautions and product-specific notes must be observed.**
4. In order to satisfy certain technical requirements, **some of the products described in this publication may contain substances subject to restrictions in certain jurisdictions (e.g. because they are classed as hazardous)**. Useful information on this will be found in our Material Data Sheets on the Internet (www.tdk-electronics.tdk.com/material). Should you have any more detailed questions, please contact our sales offices.
5. We constantly strive to improve our products. Consequently, **the products described in this publication may change from time to time**. The same is true of the corresponding product specifications. Please check therefore to what extent product descriptions and specifications contained in this publication are still applicable before or when you place an order. We also **reserve the right to discontinue production and delivery of products**. Consequently, we cannot guarantee that all products named in this publication will always be available. The aforementioned does not apply in the case of individual agreements deviating from the foregoing for customer-specific products.
6. Unless otherwise agreed in individual contracts, **all orders are subject to our General Terms and Conditions of Supply**.

Important notes

7. **Our manufacturing sites serving the automotive business apply the IATF 16949 standard.** The IATF certifications confirm our compliance with requirements regarding the quality management system in the automotive industry. Referring to customer requirements and customer specific requirements (“CSR”) TDK always has and will continue to have the policy of respecting individual agreements. Even if IATF 16949 may appear to support the acceptance of unilateral requirements, we hereby like to emphasize that **only requirements mutually agreed upon can and will be implemented in our Quality Management System.** For clarification purposes we like to point out that obligations from IATF 16949 shall only become legally binding if individually agreed upon.
8. The trade names EPCOS, CeraCharge, CeraDiode, CeraLink, CeraPad, CeraPlas, CSMP, CTVS, DeltaCap, DigiSiMic, ExoCore, FilterCap, FormFit, LeaXield, MiniBlue, MiniCell, MKD, MKK, MotorCap, PCC, PhaseCap, PhaseCube, PhaseMod, PhiCap, PowerHap, PQSine, PQvar, SIFERRIT, SIFI, SIKOREL, SilverCap, SIMDAD, SiMic, SIMID, SineFormer, SIOV, ThermoFuse, WindCap are **trademarks registered or pending** in Europe and in other countries. Further information will be found on the Internet at www.tdk-electronics.tdk.com/trademarks.

Release 2018-10