

# Aluminum electrolytic capacitors

Capacitors with 4-pin snap-in terminals and solder pins

**Series/Type:** B43513, B43523

**Date:** December 2019

## Long-life grade capacitors

### Applications

- Frequency converters
- Solar inverters
- Uninterruptible power supplies
- Professional power supplies
- Medical appliances
- Not for automotive applications unless otherwise specified

### Features

- Voltage derating ( $0.95 \cdot V_R$ ) enables 105 °C operation, more details available upon request
- Long useful life
- High ripple current capability
- High volumetric efficiency
- Many different case sizes
- Pinning ensures correct insertion
- RoHS-compatible

### Construction

- Charge/discharge-proof, polar
- Aluminum case, fully insulated with PET
- Version with additional PET insulation cap on terminal side and PVC insulation available for insulating the capacitor from the PCB (B43513 only)
- Version with PVC insulation available upon request
- Overload protection by safety vent on the case wall

### Terminals

- 4-pin snap-in terminals (6.3 mm and 4.5 mm length)
- Solder pin mounting on printed circuit boards, pins fit standardized spacings on PCB



B43513

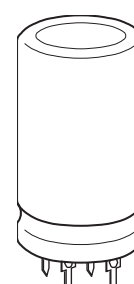

B43523

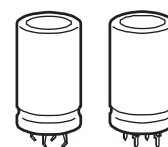
**Specifications and characteristics in brief**

Rated voltage $V_R$	350 ... 450 V DC										
Surge voltage $V_S$	$1.1 \cdot V_R$										
Rated capacitance $C_R$	270 ... 2700 $\mu\text{F}$										
Capacitance tolerance	$\pm 20\% \triangleq M$										
Dissipation factor $\tan \delta$ (20 °C, 120 Hz)	$V_R \leq 400 \text{ V DC: } \tan \delta \leq 0.15$ $V_R > 400 \text{ V DC: } \tan \delta \leq 0.20$										
Leakage current $I_{\text{leak}}$ (5 min, 20 °C)	$I_{\text{leak}} \leq 0.3 \mu\text{A} \cdot \left( \frac{C_R}{\mu\text{F}} \cdot \frac{V_R}{\text{V}} \right)^{0.7} + 4 \mu\text{A}$										
Self-inductance ESL	Approx. 20 nH										
Useful life <sup>1)</sup> 85 °C; $V_R$ ; $I_{\text{AC,R}}$	> 10000 h	Requirements: $ \Delta C/C  \leq 20\%$ of initial value $\tan \delta \leq 2$ times initial specified limit $I_{\text{leak}} \leq$ initial specified limit									
Voltage endurance test 85 °C; $V_R$	3000 h	Post test requirements: $ \Delta C/C  \leq 10\%$ of initial value $\tan \delta \leq 1.3$ times initial specified limit $I_{\text{leak}} \leq$ initial specified limit									
Vibration resistance test	To IEC 60068-2-6, test Fc: Frequency range 10 ... 55 Hz, displacement amplitude 0.35 mm, acceleration max. 5 g, duration $3 \times 2$ h. Capacitor mounted by its body which is rigidly clamped to the work surface.										
Characteristics at low temperature	Max. impedance ratio at 100 Hz	<table border="1"> <thead> <tr> <th><math>V_R</math></th> <th><math>\leq 400 \text{ V}</math></th> <th><math>&gt; 400 \text{ V}</math></th> </tr> </thead> <tbody> <tr> <td><math>Z_{-25\text{ °C}} / Z_{20\text{ °C}}</math></td> <td>3</td> <td>5</td> </tr> <tr> <td><math>Z_{-40\text{ °C}} / Z_{20\text{ °C}}</math></td> <td>7</td> <td>10</td> </tr> </tbody> </table>	$V_R$	$\leq 400 \text{ V}$	$> 400 \text{ V}$	$Z_{-25\text{ °C}} / Z_{20\text{ °C}}$	3	5	$Z_{-40\text{ °C}} / Z_{20\text{ °C}}$	7	10
$V_R$	$\leq 400 \text{ V}$	$> 400 \text{ V}$									
$Z_{-25\text{ °C}} / Z_{20\text{ °C}}$	3	5									
$Z_{-40\text{ °C}} / Z_{20\text{ °C}}$	7	10									
IEC climatic category	To IEC 60068-1: 40/085/56 (–40 °C/+85 °C/56 days damp heat test)										
Sectional specification	IEC 60384-4										

1) Refer to chapter "General technical information, 5 Useful life" on how to interpret useful life.

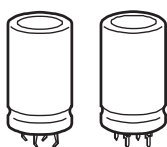

**B43513, B43523**

**Long useful life – 85 °C**

### Dimensional drawings

#### B43513, 4-pin snap-in terminals, standard insulation (PET)

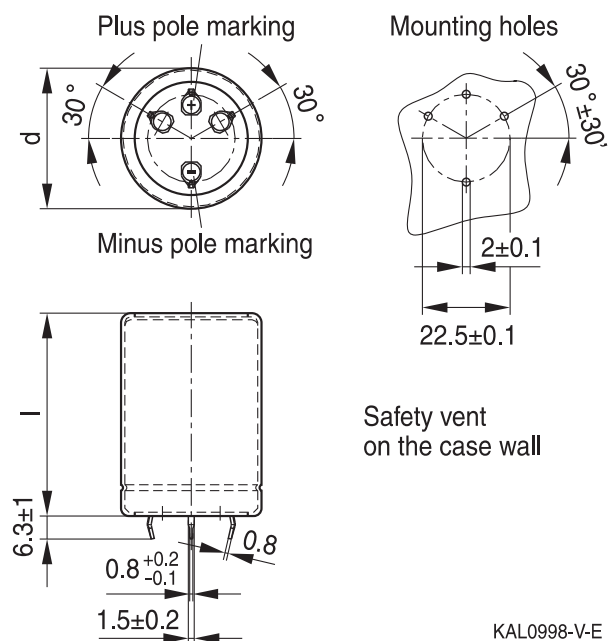

Standard snap-in terminals:

length ( $6.3 \pm 1$ ) mm.

Also available with length of ( $4.5 - 1$ ) mm.

All pin holes must be drilled into the PC-board, since the unconnected pins serve as mountings. These pins must be soldered to insulated pads or pads with the same potential as the negative pole.

Dimensions (mm)		Approx. weight (g)	Packing units (pcs.)
d +1	l ±2		
35	40	51	60
35	45	57	60
35	50	63	60
35	55	70	36
35	60	76	36
35	65	82	36
35	70	88	36
35	75	95	36
35	85	107	36
35	90	114	36
35	95	120	36
40	40	71	33
40	45	80	33
40	50	89	33
40	55	98	33
40	60	107	33
40	65	116	33
40	70	125	33
40	75	134	33
40	80	143	33
40	90	161	33
40	95	170	33
45	40	95	28
45	45	108	28
45	50	120	28
45	55	132	28
45	60	143	28
45	65	155	28
45	70	166	28
45	75	178	28
45	80	190	28
45	85	202	28
45	95	226	28
45	100	237	28

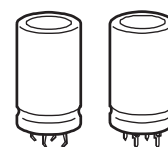
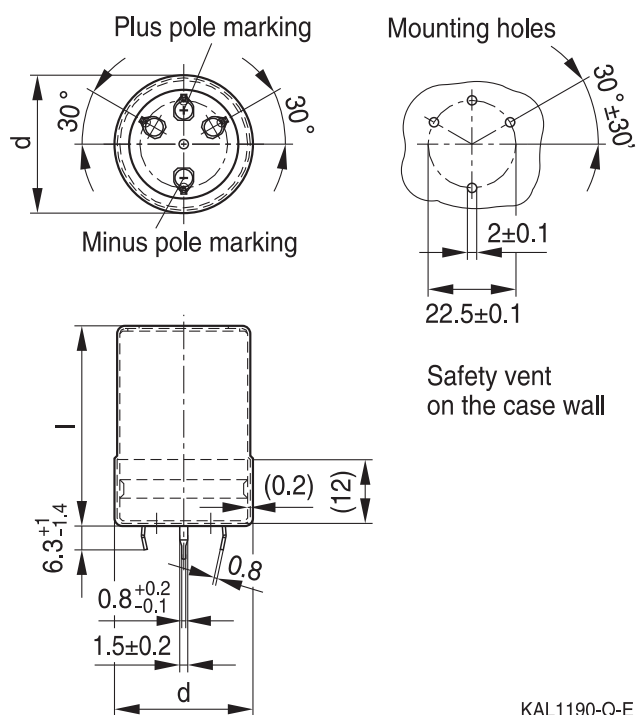
**B43513, 4-pin snap-in terminals, PVC insulation and PET insulation cap on terminal side**

KAL1190-Q-E

Standard snap-in terminals:

length (6.3 +1/–1.4) mm. Also available with length of (4.5 –1.4) mm. PET insulation cap is positioned under the insulation sleeve.

All pin holes must be drilled into the PC-board, since the unconnected pins serve as mountings. These pins must be soldered to insulated pads or pads with the same potential as the negative pole.

Dimensions (mm)		Approx. weight (g)	Packing units (pcs.)
d +1.4	l +2.2/–2		
35	40	51	60
35	45	57	60
35	50	63	60
35	55	70	36
35	60	76	36
35	65	82	36
35	70	88	36
35	75	95	36
35	85	107	36
35	90	114	36
35	95	120	36
40	40	71	33
40	45	80	33
40	50	89	33
40	55	98	33
40	60	107	33
40	65	116	33
40	70	125	33
40	75	134	33
40	80	143	33
40	90	161	33
40	95	170	33
45	40	95	28
45	45	108	28
45	50	120	28
45	55	132	28
45	60	143	28
45	65	155	28
45	70	166	28
45	75	178	28
45	80	190	28
45	85	202	28
45	95	226	28
45	100	237	28

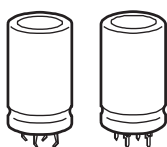

**B43513, B43523**

**Long useful life – 85 °C**

**B43523, solder pins**

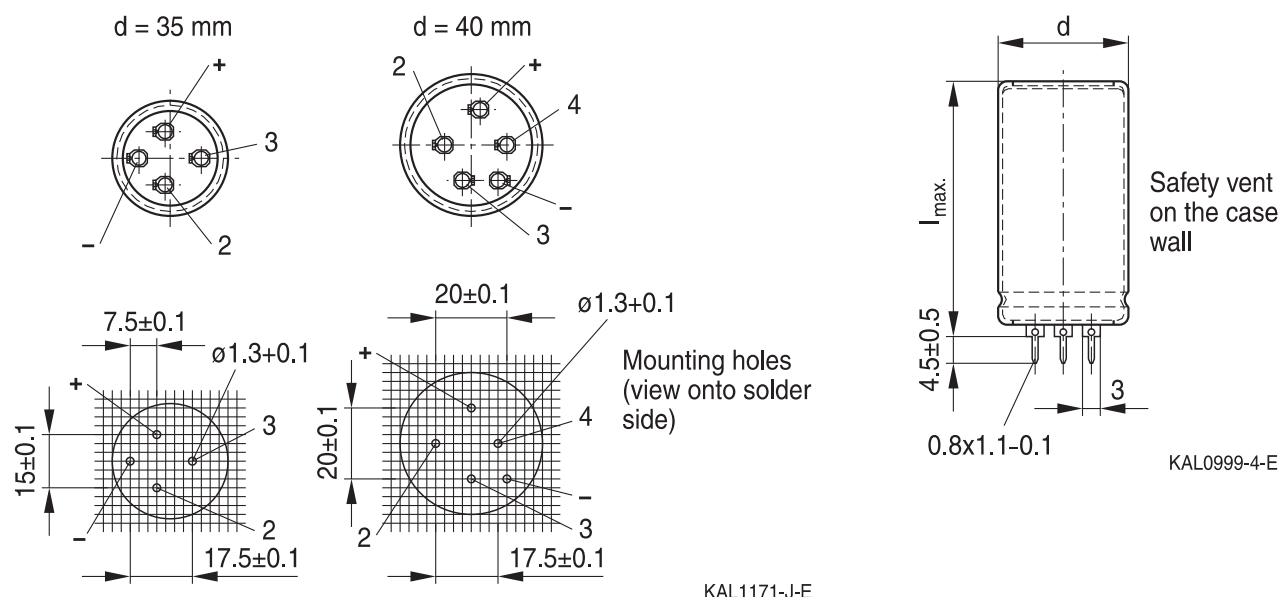

Pole markings: Plus: +; Minus: –

All pin holes must be drilled into the PC-board, since the unconnected pins serve as mountings. These pins must be soldered to insulated pads or pads with the same potential as the negative pole.

Dimensions (mm)		Approx. weight (g)	Packing units (pcs.)
d +1	$l_{\text{max}}$		
35	44	51	60
35	49	57	60
35	54	63	60
35	59	70	36
35	64	76	36
35	69	82	36
35	74	88	36
35	79	95	36
35	89	107	36
35	94	114	36
35	99	120	36

Dimensions (mm)		Approx. weight (g)	Packing units (pcs.)
d +1	$l_{\text{max}}$		
40	44	71	33
40	49	80	33
40	54	89	33
40	59	98	33
40	64	107	33
40	69	116	33
40	74	125	33
40	79	134	33
40	84	143	33
40	94	161	33
40	99	170	33

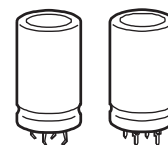

### Packing of 4-pin snap-in terminal and solder pin capacitors



For ecological reasons the packing is pure cardboard.

### Ordering codes for terminal styles and insulation features

Identification in 3<sup>rd</sup> block of ordering code

4-pin snap-in terminal capacitors

Terminal version	Insulation version	
	PET	PVC plus PET cap
Standard terminals 6.3 mm	M060	M080
Short terminals 4.5 mm	M067	M087

Ordering examples:

B43513A9188M067 } 4-pin snap-in capacitor with short terminals and PET insulation

B43513A9188M080 } 4-pin snap-in capacitor with standard terminals and PVC insulation with additional PET insulation cap on terminal side

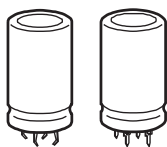

**B43513, B43523**

**Long useful life – 85 °C**

### Overview of available types

The capacitance and voltage ratings listed below are available in different case sizes upon request. Other voltage and capacitance ratings are also available upon request.

Capacitors with solder pins are only available in 35 and 40 mm case diameters.

$V_R$ (V DC)	350	400	420	450
	Case dimensions $d \times l$ (mm)			
$C_R$ ( $\mu$ F)				
270				35 × 40
330			35 × 40	35 × 45
390	35 × 40	35 × 45	35 × 45	35 × 50 40 × 40
470	35 × 45	35 × 50 40 × 40	35 × 50 40 × 40	35 × 55 40 × 45 45 × 40
560	35 × 50 40 × 40	35 × 55 40 × 45 45 × 40	35 × 55 40 × 45 45 × 40	35 × 65 40 × 50 45 × 40
680	35 × 55 40 × 45	35 × 60 40 × 50 45 × 40	35 × 65 40 × 55 45 × 40	35 × 75 40 × 60 45 × 45
820	35 × 60 40 × 50 45 × 40	35 × 70 40 × 55 45 × 45	35 × 75 40 × 60 45 × 45	35 × 85 40 × 65 45 × 55
1000	35 × 70 40 × 55 45 × 45	35 × 85 40 × 65 45 × 50	35 × 90 40 × 70 45 × 55	40 × 80 45 × 60
1200	35 × 85 40 × 65 45 × 50	35 × 95 40 × 75 45 × 60	40 × 80 45 × 65	40 × 90 45 × 70
1500	40 × 80 45 × 60	40 × 90 45 × 70	40 × 95 45 × 75	45 × 85
1800	40 × 90 45 × 70	45 × 80	45 × 85	45 × 100
2200	45 × 80	45 × 95		
2700	45 × 100			

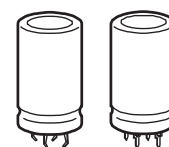

**Technical data and ordering codes**

$C_R$ 100 Hz 20 °C $\mu\text{F}$	Case dimensions $d \times l$ mm	$\text{ESR}_{\text{typ}}$ 100 Hz 20 °C m $\Omega$	$\text{ESR}_{\text{typ}}$ 300 Hz 60 °C m $\Omega$	$Z_{\text{max}}$ 10 kHz 20 °C m $\Omega$	$I_{\text{AC,max}}$ 100 Hz 60 °C A	$I_{\text{AC,R}}$ 100 Hz 85 °C A	Ordering code (composition see below)
<b><math>V_R = 350 \text{ V DC}</math></b>							
390	35 × 40	180	55	240	4.63	2.57	B435*3A4397M0##
470	35 × 45	150	45	200	5.24	2.91	B435*3A4477M0##
560	35 × 50	120	40	170	5.90	3.28	B435*3A4567M0##
560	40 × 40	130	45	180	5.91	3.28	B435*3B4567M0##
680	35 × 55	100	34	140	6.73	3.74	B435*3A4687M0##
680	40 × 45	100	36	150	6.70	3.72	B435*3B4687M0##
820	35 × 60	85	28	120	7.68	4.26	B435*3A4827M0##
820	40 × 50	90	32	120	7.57	4.21	B435*3B4827M0##
820	45 × 40	90	34	130	7.46	4.14	B43513C4827M0##
1000	35 × 70	70	24	95	8.90	4.95	B435*3A4108M0##
1000	40 × 55	75	26	100	8.62	4.78	B435*3B4108M0##
1000	45 × 45	75	30	110	8.44	4.68	B43513C4108M0##
1200	35 × 85	60	20	80	10.2	5.71	B435*3A4128M0##
1200	40 × 65	60	22	85	9.85	5.47	B435*3B4128M0##
1200	45 × 50	65	26	90	9.47	5.25	B43513C4128M0##
1500	40 × 80	50	17	70	11.6	6.47	B435*3A4158M0##
1500	45 × 60	50	20	75	11.0	6.15	B43513B4158M0##
1800	40 × 90	40	15	60	13.3	7.39	B435*3A4188M0##
1800	45 × 70	40	17	60	12.6	7.00	B43513B4188M0##
2200	45 × 80	36	14	50	14.5	8.06	B43513A4228M0##
2700	45 × 100	30	12	40	17.0	9.48	B43513A4278M0##

Capacitors with solder pins are only available in 35 and 40 mm case diameters.

**Composition of ordering code**

\* = Terminal type

1 = 4-pin snap-in terminals

2 = solder pin

## = Terminal style and insulation feature

60 = solder pin or 4-pin snap-in standard terminals and PET insulation

67 = 4-pin snap-in short terminals and PET insulation

80 = 4-pin snap-in standard terminals and PVC insulation with additional PET insulation cap on terminal side

87 = 4-pin snap-in short terminals and PVC insulation with additional PET insulation cap on terminal side

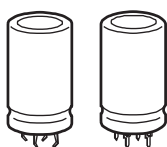

**B43513, B43523**

**Long useful life – 85 °C**

**Technical data and ordering codes**

$C_R$	Case dimensions	$ESR_{typ}$ 100 Hz	$ESR_{typ}$ 300 Hz	$Z_{max}$ 10 kHz	$I_{AC,max}$ 100 Hz	$I_{AC,R}$ 100 Hz	Ordering code (composition see below)
100 Hz	$d \times l$	20 °C	60 °C	20 °C	60 °C	85 °C	
20 °C	mm	mΩ	mΩ	mΩ	A	A	
μF							
<b><math>V_R = 400</math> V DC</b>							
390	35 × 45	190	60	270	4.83	2.68	B435*3A9397M0##
470	35 × 50	160	50	230	5.46	3.04	B435*3A9477M0##
470	40 × 40	160	50	230	5.49	3.05	B435*3B9477M0##
560	35 × 55	140	40	190	6.16	3.43	B435*3A9567M0##
560	40 × 45	140	45	200	6.16	3.42	B435*3B9567M0##
560	45 × 40	140	45	200	6.27	3.48	B43513C9567M0##
680	35 × 60	110	36	160	7.07	3.93	B435*3A9687M0##
680	40 × 50	110	38	160	7.00	3.89	B435*3B9687M0##
680	45 × 40	120	40	170	6.93	3.84	B43513C9687M0##
820	35 × 70	95	30	130	8.13	4.52	B435*3A9827M0##
820	40 × 55	95	32	140	7.93	4.40	B435*3B9827M0##
820	45 × 45	100	34	140	7.80	4.33	B43513C9827M0##
1000	35 × 85	75	24	110	9.48	5.27	B435*3A9108M0##
1000	40 × 65	80	26	110	9.14	5.08	B435*3B9108M0##
1000	45 × 50	80	30	120	8.84	4.90	B43513C9108M0##
1200	35 × 95	65	20	90	10.9	6.08	B435*3A9128M0##
1200	40 × 75	65	22	95	10.4	5.80	B435*3B9128M0##
1200	45 × 60	65	24	95	10.1	5.61	B43513C9128M0##
1500	40 × 90	50	18	75	12.3	6.87	B435*3A9158M0##
1500	45 × 70	55	20	80	11.7	6.54	B43513B9158M0##
1800	45 × 80	45	17	65	13.4	7.45	B43513A9188M0##
2200	45 × 95	38	14	55	15.6	8.67	B43513A9228M0##

Capacitors with solder pins are only available in 35 and 40 mm case diameters.

**Composition of ordering code**

\* = Terminal type

1 = 4-pin snap-in terminals

2 = solder pin

## = Terminal style and insulation feature

60 = solder pin or 4-pin snap-in standard terminals and PET insulation

67 = 4-pin snap-in short terminals and PET insulation

80 = 4-pin snap-in standard terminals and PVC insulation with additional PET insulation cap on terminal side

87 = 4-pin snap-in short terminals and PVC insulation with additional PET insulation cap on terminal side

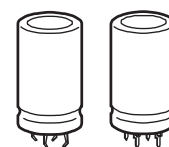
**Technical data and ordering codes**

$C_R$	Case dimensions	$ESR_{typ}$ 100 Hz	$ESR_{typ}$ 300 Hz	$Z_{max}$ 10 kHz	$I_{AC,max}$ 100 Hz	$I_{AC,R}$ 100 Hz	Ordering code (composition see below)
100 Hz	$d \times l$	20 °C	60 °C	20 °C	60 °C	85 °C	
$\mu F$	mm	m $\Omega$	m $\Omega$	m $\Omega$	A	A	
<b><math>V_R = 420</math> V DC</b>							
330	35 × 40	310	85	470	4.18	2.32	B435*3A0337M0##
390	35 × 45	260	70	400	4.69	2.60	B435*3A0397M0##
470	35 × 50	220	60	330	5.32	2.96	B435*3A0477M0##
470	40 × 40	220	60	340	5.34	2.96	B435*3B0477M0##
560	35 × 55	190	50	280	6.02	3.34	B435*3A0567M0##
560	40 × 45	190	55	280	6.00	3.33	B435*3B0567M0##
560	45 × 40	190	55	290	6.08	3.38	B43513C0567M0##
680	35 × 65	150	40	230	6.95	3.86	B435*3A0687M0##
680	40 × 55	150	45	230	6.89	3.83	B435*3B0687M0##
680	45 × 40	160	50	240	6.73	3.73	B43513C0687M0##
820	35 × 75	130	34	190	8.00	4.45	B435*3A0827M0##
820	40 × 60	130	36	200	7.81	4.34	B435*3B0827M0##
820	45 × 45	130	40	200	7.59	4.21	B43513C0827M0##
1000	35 × 90	100	28	160	9.35	5.20	B435*3A0108M0##
1000	40 × 70	110	30	160	9.02	5.01	B435*3B0108M0##
1000	45 × 55	110	32	170	8.78	4.87	B43513C0108M0##
1200	40 × 80	90	26	140	10.3	5.73	B435*3A0128M0##
1200	45 × 65	90	28	140	10.0	5.56	B43513B0128M0##
1500	40 × 95	70	20	110	12.2	6.79	B435*3A0158M0##
1500	45 × 75	70	22	110	11.6	6.49	B43513B0158M0##
1800	45 × 85	60	19	95	13.3	7.40	B43513A0188M0##

Capacitors with solder pins are only available in 35 and 40 mm case diameters.

**Composition of ordering code**

\* = Terminal type

1 = 4-pin snap-in terminals

2 = solder pin

## = Terminal style and insulation feature

60 = solder pin or 4-pin snap-in standard terminals and PET insulation

67 = 4-pin snap-in short terminals and PET insulation

80 = 4-pin snap-in standard terminals and PVC insulation with additional PET insulation cap on terminal side

87 = 4-pin snap-in short terminals and PVC insulation with additional PET insulation cap on terminal side

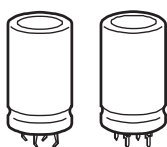

**B43513, B43523**

**Long useful life – 85 °C**

**Technical data and ordering codes**

$C_R$ 100 Hz 20 °C $\mu\text{F}$	Case dimensions $d \times l$ mm	$\text{ESR}_{\text{typ}}$ 100 Hz 20 °C m $\Omega$	$\text{ESR}_{\text{typ}}$ 300 Hz 60 °C m $\Omega$	$Z_{\text{max}}$ 10 kHz 20 °C m $\Omega$	$I_{\text{AC,max}}$ 100 Hz 60 °C A	$I_{\text{AC,R}}$ 100 Hz 85 °C A	Ordering code (composition see below)
<b><math>V_R = 450 \text{ V DC}</math></b>							
270	35 × 40	360	95	530	3.80	2.11	B435*3A5277M0##
330	35 × 45	290	80	430	4.34	2.41	B435*3A5337M0##
390	35 × 50	250	65	370	4.86	2.70	B435*3A5397M0##
390	40 × 40	250	70	370	4.90	2.72	B435*3B5397M0##
470	35 × 55	210	55	310	5.54	3.08	B435*3A5477M0##
470	40 × 45	210	60	310	5.55	3.08	B435*3B5477M0##
470	45 × 40	210	60	310	5.65	3.14	B43513C5477M0##
560	35 × 65	170	45	260	6.30	3.50	B435*3A5567M0##
560	40 × 50	180	50	260	6.24	3.46	B435*3B5567M0##
560	45 × 40	180	50	270	6.20	3.44	B43513C5567M0##
680	35 × 75	140	38	210	7.28	4.05	B435*3A5687M0##
680	40 × 60	140	40	220	7.16	3.98	B435*3B5687M0##
680	45 × 45	150	45	220	7.03	3.90	B43513C5687M0##
820	35 × 85	120	32	180	8.41	4.68	B435*3A5827M0##
820	40 × 65	120	34	180	8.15	4.53	B435*3B5827M0##
820	45 × 55	120	36	190	8.05	4.47	B43513C5827M0##
1000	40 × 80	100	28	150	9.45	5.26	B435*3A5108M0##
1000	45 × 60	100	32	150	9.15	5.08	B43513B5108M0##
1200	40 × 90	80	24	130	10.8	6.02	B435*3A5128M0##
1200	45 × 70	85	26	130	10.4	5.79	B43513B5128M0##
1500	45 × 85	70	22	110	12.3	6.84	B43513A5158M0##
1800	45 × 100	55	18	85	14.1	7.86	B43513A5188M0##

Capacitors with solder pins are only available in 35 and 40 mm case diameters.

**Composition of ordering code**

\* = Terminal type

1 = 4-pin snap-in terminals

2 = solder pin

## = Terminal style and insulation feature

60 = solder pin or 4-pin snap-in standard terminals and PET insulation

67 = 4-pin snap-in short terminals and PET insulation

80 = 4-pin snap-in standard terminals and PVC insulation with additional PET insulation cap on terminal side

87 = 4-pin snap-in short terminals and PVC insulation with additional PET insulation cap on terminal side

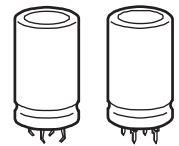

### Useful life<sup>1)</sup>

For useful life calculations, please use our web-based "AlCap Useful Life Calculation Tool", which can be found on the Internet under the following link:

[www.tdk-electronics.tdk.com/alcap](http://www.tdk-electronics.tdk.com/alcap)

The AlCap Useful Life Calculation Tool provides calculations of useful life as well as additional data for selected capacitor types under operating conditions defined by the user.

In addition, it is possible to calculate useful life expectancies based on temperatures measured by the user in the application.

### Frequency characteristics of ESR

Typical behavior

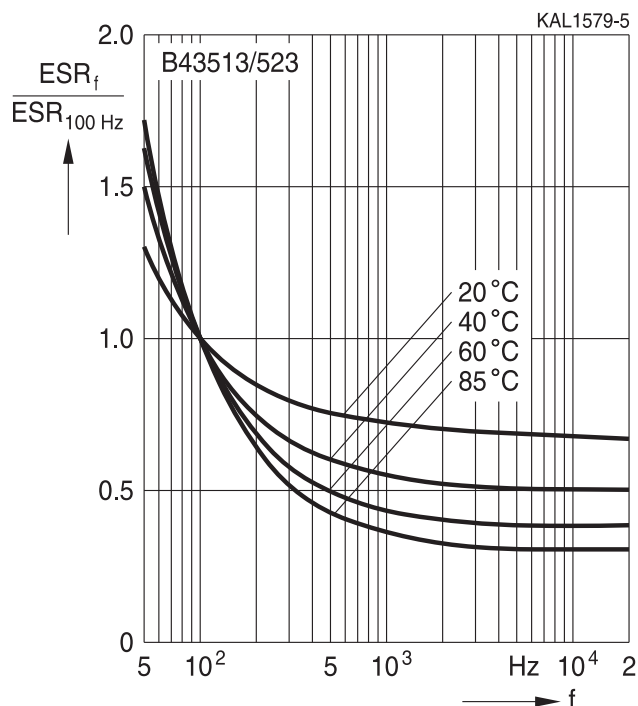

### Impedance Z versus frequency f

Typical behavior at 20 °C

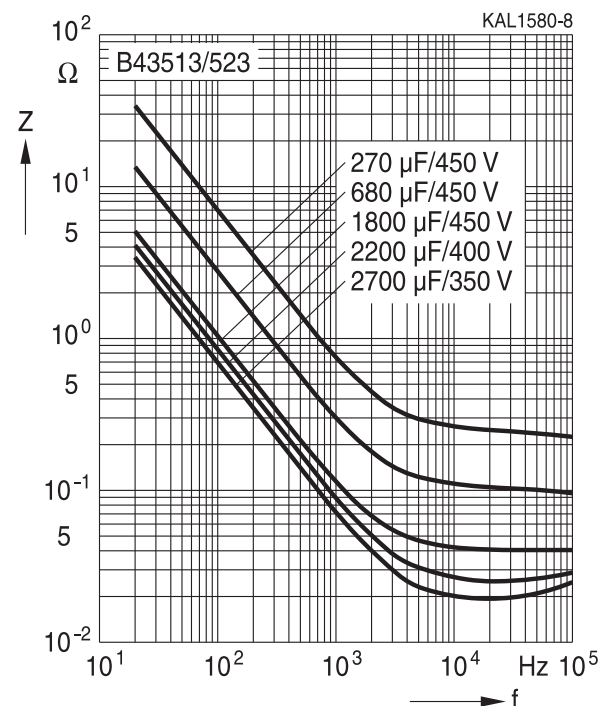

1) Refer to chapter "General technical information, 5 Useful life" on how to interpret useful life.

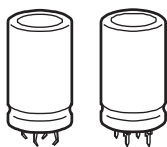

**B43513, B43523**

**Long useful life – 85 °C**

## Cautions and warnings

### Personal safety

The electrolytes used have been optimized both with a view to the intended application and with regard to health and environmental compatibility. They do not contain any solvents that are detrimental to health, e.g. dimethyl formamide (DMF) or dimethyl acetamide (DMAC). Furthermore, some of the high-voltage electrolytes used are self-extinguishing.

As far as possible, we do not use any dangerous chemicals or compounds to produce operating electrolytes, although in exceptional cases, such materials must be used in order to achieve specific physical and electrical properties because no alternative materials are currently known. We do, however, restrict the amount of dangerous materials used in our products to an absolute minimum.

Materials and chemicals used in our aluminum electrolytic capacitors are continuously adapted in compliance with the TDK Electronics Corporate Environmental Policy and the latest EU regulations and guidelines such as RoHS, REACH/SVHC, GADSL, and ELV.

MDS (Material Data Sheets) are available on our website for all types listed in the data book. MDS for customer specific capacitors are available upon request.

MSDS (Material Safety Data Sheets) are available for our electrolytes upon request.

Nevertheless, the following rules should be observed when handling aluminum electrolytic capacitors: No electrolyte should come into contact with eyes or skin. If electrolyte does come into contact with the skin, wash the affected areas immediately with running water. If the eyes are affected, rinse them for 10 minutes with plenty of water. If symptoms persist, seek medical treatment. Avoid inhaling electrolyte vapor or mists. Workplaces and other affected areas should be well ventilated. Clothing that has been contaminated by electrolyte must be changed and rinsed in water.

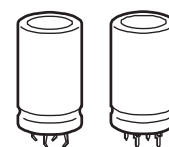

## Product safety

The table below summarizes the safety instructions that must be observed without fail. A detailed description can be found in the relevant sections of separate file chapter "General technical information".

Topic	Safety information	Reference chapter "General technical information"
Polarity	Make sure that polar capacitors are connected with the right polarity.	1 "Basic construction of aluminum electrolytic capacitors"
Reverse voltage	Voltages of opposite polarity should be prevented by connecting a diode.	3.1.6 "Reverse voltage"
Mounting position of screw-terminal capacitors	Screw terminal capacitors must not be mounted with terminals facing down unless otherwise specified.	11.1. "Mounting positions of capacitors with screw terminals"
Robustness of terminals	The following maximum tightening torques must not be exceeded when connecting screw terminals: M5: 2.5 Nm M6: 4.0 Nm	11.3 "Mounting torques"
Mounting of single-ended capacitors	The internal structure of single-ended capacitors might be damaged if excessive force is applied to the lead wires. Avoid any compressive, tensile or flexural stress. Do not move the capacitor after soldering to PC board. Do not pick up the PC board by the soldered capacitor. Do not insert the capacitor on the PC board with a hole space different to the lead space specified.	11.4 "Mounting considerations for single-ended capacitors"
Soldering	Do not exceed the specified time or temperature limits during soldering.	11.5 "Soldering"
Soldering, cleaning agents	Do not allow halogenated hydrocarbons to come into contact with aluminum electrolytic capacitors.	11.6 "Cleaning agents"
Upper category temperature	Do not exceed the upper category temperature.	7.2 "Maximum permissible operating temperature"
Passive flammability	Avoid external energy, e.g. fire.	8.1 "Passive flammability"

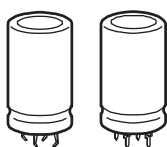

**B43513, B43523**

**Long useful life – 85 °C**

Topic	Safety information	Reference chapter "General technical information"
Active flammability	Avoid overload of the capacitors.	8.2 "Active flammability"
Maintenance	Make periodic inspections of the capacitors. Before the inspection, make sure that the power supply is turned off and carefully discharge the capacitors. Do not apply excessive mechanical stress to the capacitor terminals when mounting.	10 "Maintenance"
Storage	Do not store capacitors at high temperatures or high humidity. Capacitors should be stored at +5 to +35 °C and a relative humidity of ≤ 75%.	7.3 "Shelf life and storage conditions"
		Reference chapter "Capacitors with screw terminals"
Breakdown strength of insulating sleeves	Do not damage the insulating sleeve, especially when ring clips are used for mounting.	"Screw terminals – accessories"

### Display of ordering codes for TDK Electronics products

The ordering code for one and the same product can be represented differently in data sheets, data books, other publications, on the company website, or in order-related documents such as shipping notes, order confirmations and product labels. The varying representations of the ordering codes are due to different processes employed and do not affect the specifications of the respective products.

Detailed information can be found on the Internet under [www.tdk-electronics.tdk.com/orderingcodes](http://www.tdk-electronics.tdk.com/orderingcodes).

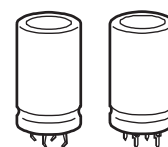

**Symbols and terms**

Symbol	English	German
C	Capacitance	Kapazität
$C_R$	Rated capacitance	Nennkapazität
$C_S$	Series capacitance	Serienkapazität
$C_{S,T}$	Series capacitance at temperature T	Serienkapazität bei Temperatur T
$C_f$	Capacitance at frequency f	Kapazität bei Frequenz f
d	Case diameter, nominal dimension	Gehäusedurchmesser, Nennmaß
$d_{max}$	Maximum case diameter	Maximaler Gehäusedurchmesser
ESL	Self-inductance	Eigeninduktivität
ESR	Equivalent series resistance	Ersatzserienwiderstand
$ESR_f$	Equivalent series resistance at frequency f	Ersatzserienwiderstand bei Frequenz f
$ESR_T$	Equivalent series resistance at temperature T	Ersatzserienwiderstand bei Temperatur T
f	Frequency	Frequenz
I	Current	Strom
$I_{AC}$	Alternating current (ripple current)	Wechselstrom
$I_{AC,RMS}$	Root-mean-square value of alternating current	Wechselstrom, Effektivwert
$I_{AC,f}$	Ripple current at frequency f	Wechselstrom bei Frequenz f
$I_{AC,max}$	Maximum permissible ripple current	Maximal zulässiger Wechselstrom
$I_{AC,R}$	Rated ripple current	Nennwechselstrom
$I_{leak}$	Leakage current	Reststrom
$I_{leak,op}$	Operating leakage current	Betriebsreststrom
l	Case length, nominal dimension	Gehäuselänge, Nennmaß
$l_{max}$	Maximum case length (without terminals and mounting stud)	Maximale Gehäuselänge (ohne Anschlüsse und Gewindebolzen)
R	Resistance	Widerstand
$R_{ins}$	Insulation resistance	Isolationswiderstand
$R_{symm}$	Balancing resistance	Symmetrierwiderstand
T	Temperature	Temperatur
$\Delta T$	Temperature difference	Temperaturdifferenz
$T_A$	Ambient temperature	Umgebungstemperatur
$T_C$	Case temperature	Gehäusetemperatur
$T_B$	Capacitor base temperature	Temperatur des Gehäusebodens
t	Time	Zeit
$\Delta t$	Period	Zeitraum
$t_b$	Service life (operating hours)	Brauchbarkeitsdauer (Betriebszeit)

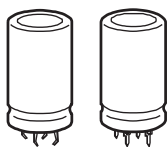

B43513, B43523

Long useful life – 85 °C

Symbol	English	German
V	Voltage	Spannung
$V_F$	Forming voltage	Formierspannung
$V_{op}$	Operating voltage	Betriebsspannung
$V_R$	Rated voltage, DC voltage	Nennspannung, Gleichspannung
$V_S$	Surge voltage	Spitzenspannung
$X_C$	Capacitive reactance	Kapazitiver Blindwiderstand
$X_L$	Inductive reactance	Induktiver Blindwiderstand
Z	Impedance	Scheinwiderstand
$Z_T$	Impedance at temperature T	Scheinwiderstand bei Temperatur T
$\tan \delta$	Dissipation factor	Verlustfaktor
$\lambda$	Failure rate	Ausfallrate
$\epsilon_0$	Absolute permittivity	Elektrische Feldkonstante
$\epsilon_r$	Relative permittivity	Dielektrizitätszahl
$\omega$	Angular velocity; $2 \cdot \pi \cdot f$	Kreisfrequenz; $2 \cdot \pi \cdot f$

### Note

All dimensions are given in mm.

## Important notes

The following applies to all products named in this publication:

1. Some parts of this publication contain **statements about the suitability of our products for certain areas of application**. These statements are based on our knowledge of typical requirements that are often placed on our products in the areas of application concerned. We nevertheless expressly point out **that such statements cannot be regarded as binding statements about the suitability of our products for a particular customer application**. As a rule, we are either unfamiliar with individual customer applications or less familiar with them than the customers themselves. For these reasons, it is always ultimately incumbent on the customer to check and decide whether a product with the properties described in the product specification is suitable for use in a particular customer application.
2. We also point out that **in individual cases, a malfunction of electronic components or failure before the end of their usual service life cannot be completely ruled out in the current state of the art, even if they are operated as specified**. In customer applications requiring a very high level of operational safety and especially in customer applications in which the malfunction or failure of an electronic component could endanger human life or health (e.g. in accident prevention or lifesaving systems), it must therefore be ensured by means of suitable design of the customer application or other action taken by the customer (e.g. installation of protective circuitry or redundancy) that no injury or damage is sustained by third parties in the event of malfunction or failure of an electronic component.
3. **The warnings, cautions and product-specific notes must be observed.**
4. In order to satisfy certain technical requirements, **some of the products described in this publication may contain substances subject to restrictions in certain jurisdictions (e.g. because they are classed as hazardous)**. Useful information on this will be found in our Material Data Sheets on the Internet ([www.tdk-electronics.tdk.com/material](http://www.tdk-electronics.tdk.com/material)). Should you have any more detailed questions, please contact our sales offices.
5. We constantly strive to improve our products. Consequently, **the products described in this publication may change from time to time**. The same is true of the corresponding product specifications. Please check therefore to what extent product descriptions and specifications contained in this publication are still applicable before or when you place an order. We also **reserve the right to discontinue production and delivery of products**. Consequently, we cannot guarantee that all products named in this publication will always be available. The aforementioned does not apply in the case of individual agreements deviating from the foregoing for customer-specific products.
6. Unless otherwise agreed in individual contracts, **all orders are subject to our General Terms and Conditions of Supply**.

## Important notes

7. **Our manufacturing sites serving the automotive business apply the IATF 16949 standard.** The IATF certifications confirm our compliance with requirements regarding the quality management system in the automotive industry. Referring to customer requirements and customer specific requirements (“CSR”) TDK always has and will continue to have the policy of respecting individual agreements. Even if IATF 16949 may appear to support the acceptance of unilateral requirements, we hereby like to emphasize that **only requirements mutually agreed upon can and will be implemented in our Quality Management System.** For clarification purposes we like to point out that obligations from IATF 16949 shall only become legally binding if individually agreed upon.
8. The trade names EPCOS, CeraCharge, CeraDiode, CeraLink, CeraPad, CeraPlas, CSMP, CTVS, DeltaCap, DigiSiMic, ExoCore, FilterCap, FormFit, LeaXield, MiniBlue, MiniCell, MKD, MKK, MotorCap, PCC, PhaseCap, PhaseCube, PhaseMod, PhiCap, PowerHap, PQSine, PQvar, SIFERRIT, SIFI, SIKOREL, SilverCap, SIMDAD, SiMic, SIMID, SineFormer, SIOV, ThermoFuse, WindCap are **trademarks registered or pending** in Europe and in other countries. Further information will be found on the Internet at [www.tdk-electronics.tdk.com/trademarks](http://www.tdk-electronics.tdk.com/trademarks).

Release 2018-10