

Mini-ISO Automotive Relay

CB RELAYS

<Protective construction>
Flux tight/Sealed

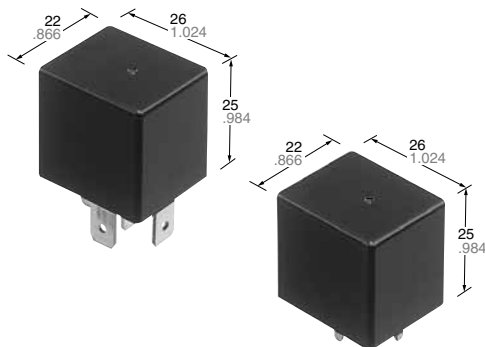

(Unit: mm inch)

RoHS compliant

FEATURES

- This relay has an Mini-ISO (International Organization for Standardization) terminal arrangement.
- Compact and high capacity
- Features heat resistant type
- Built-in resistor type is also available.

TYPICAL APPLICATIONS

- **Automobiles**
Cell motors, Air conditioners, ABS, EPS, etc.
- **Construction equipment**
- **Agricultural equipment, Conveyor, etc.**

ORDERING INFORMATION



TYPES

| Contact arrangement | Mounting classification | Rated coil voltage | Standard type | | Heat resistant type | | Packing | |
|-----------------------------------|-------------------------|--------------------|---------------|--------------|---------------------|----------------|---------|----------|
| | | | Sealed | Flux tight | Sealed | Flux tight | Carton | Case |
| | | | Type No. | Type No. | Type No. | Type No. | | |
| 1 Form A | PC board type | 12V DC | CB1a-P-12V | CB1aF-P-12V | CB1a-T-P-12V | CB1aF-T-P-12V | 50 pcs. | 200 pcs. |
| | | 24V DC | CB1a-P-24V | CB1aF-P-24V | CB1a-T-P-24V | CB1aF-T-P-24V | | |
| | Plug-in type | 12V DC | CB1a-12V | CB1aF-12V | CB1a-T-12V | CB1aF-T-12V | | |
| | | 24V DC | CB1a-24V | CB1aF-24V | CB1a-T-24V | CB1aF-T-24V | | |
| | Bracket type | 12V DC | CB1a-M-12V | CB1aF-M-12V | CB1a-T-M-12V | CB1aF-T-M-12V | | |
| | | 24V DC | CB1a-M-24V | CB1aF-M-24V | CB1a-T-M-24V | CB1aF-T-M-24V | | |
| 1 Form C | PC board type | 12V DC | CB1-P-12V | CB1F-P-12V | CB1-T-P-12V | CB1F-T-P-12V | | |
| | | 24V DC | CB1-P-24V | CB1F-P-24V | CB1-T-P-24V | CB1F-T-P-24V | | |
| | Plug-in type | 12V DC | CB1-12V | CB1F-12V | CB1-T-12V | CB1F-T-12V | | |
| | | 24V DC | CB1-24V | CB1F-24V | CB1-T-24V | CB1F-T-24V | | |
| | Bracket type | 12V DC | CB1-M-12V | CB1F-M-12V | CB1-T-M-12V | CB1F-T-M-12V | | |
| | | 24V DC | CB1-M-24V | CB1F-M-24V | CB1-T-M-24V | CB1F-T-M-24V | | |
| 1 Form A High contact capacity | PC board type | 12V DC | CB1aH-P-12V | CB1aHF-P-12V | CB1aH-T-P-12V | CB1aHF-T-P-12V | | |
| | | 24V DC | CB1aH-P-24V | CB1aHF-P-24V | CB1aH-T-P-24V | CB1aHF-T-P-24V | | |
| | Plug-in type | 12V DC | CB1aH-12V | CB1aHF-12V | CB1aH-T-12V | CB1aHF-T-12V | | |
| | | 24V DC | CB1aH-24V | CB1aHF-24V | CB1aH-T-24V | CB1aHF-T-24V | | |
| | Bracket type | 12V DC | CB1aH-M-12V | CB1aHF-M-12V | CB1aH-T-M-12V | CB1aHF-T-M-12V | | |
| | | 24V DC | CB1aH-M-24V | CB1aHF-M-24V | CB1aH-T-M-24V | CB1aHF-T-M-24V | | |

Note: Please use "CB***R**" to order with resistor inside type. (Asterisks "*" should be filled in from ORDERING INFORMATION.)

RATING

1. Coil data

1) No protective element

| Contact arrangement | Rated coil voltage | Operate (Set) voltage (at 20°C 68°F) (Initial) | Release (Reset) voltage (at 20°C 68°F) (Initial) | Rated operating current [±10%] (at 20°C 68°F) | Coil resistance [±10%] (at 20°C 68°F) | Rated operating power (at 20°C 68°F) | Usable voltage range |
|-----------------------------------|--------------------|--|--|---|---------------------------------------|--------------------------------------|----------------------|
| 1 Form A, 1 Form C | 12V DC | 3 to 7V DC | 1.2 to 4.2V DC | 117mA | 103Ω | 1.4W | 10 to 16V DC |
| | 24V DC | 6 to 14V DC | 2.4 to 8.4V DC | 75mA | 320Ω | 1.8W | 20 to 32V DC |
| 1 Form A High contact capacity | 12V DC | 3 to 7V DC | 1.2 to 4.2V DC | 117mA | 103Ω | 1.4W (PC board type) | 10 to 16V DC |
| | | | | 150mA | 80Ω | 1.8W | |
| | 24V DC | 6 to 14V DC | 2.4 to 8.4V DC | 58mA | 411Ω | 1.4W (PC board type) | 20 to 32V DC |
| | | | | 75mA | 320Ω | 1.8W | |

Note: Other operate (set) voltage types are also available. Please inquire our sales representative for details.

2) With resistor inside

| Contact arrangement | Rated coil voltage | Operate (Set) voltage (at 20°C 68°F) (Initial) | Release (Reset) voltage (at 20°C 68°F) (Initial) | Rated operating current [±10%] (at 20°C 68°F) | Equivalent coil resistance [±10%] (at 20°C 68°F) | Rated operating power (at 20°C 68°F) | Usable voltage range |
|-----------------------------------|--------------------|--|--|---|--|--------------------------------------|----------------------|
| 1 Form A, 1 Form C | 12V DC | 3 to 7V DC | 1.2 to 4.2V DC | 134mA | 89.5Ω | 1.6W | 10 to 16V DC |
| | 24V DC | 6 to 14V DC | 2.4 to 8.4V DC | 84mA | 287.2Ω | 2.0W | 20 to 32V DC |
| 1 Form A High contact capacity | 12V DC | 3 to 7V DC | 1.2 to 4.2V DC | 134mA | 89.5Ω | 1.6W (PC board type) | 10 to 16V DC |
| | | | | 168mA | 71.6Ω | 2.0W | |
| | 24V DC | 6 to 14V DC | 2.4 to 8.4V DC | 67mA | 358Ω | 1.6W (PC board type) | 20 to 32V DC |
| | | | | 84mA | 287.2Ω | 2.0W | |

2. Specifications

1) Standard type (12 V coil voltage)

| Item | | Specification | | |
|-----------------------------------|--|--|--|---|
| Contact data | Contact arrangement | 1 Form A | 1 Form C | 1 Form A High contact capacity |
| | Contact resistance (initial) | Max. 15mΩ (Typ. 2mΩ) (By voltage drop 1A 6V DC) | | |
| | Contact material | Ag alloy | | |
| | Rated switching capacity (resistive) | 40A 14V DC | N.O. side: 40A 14V DC N.C. side: 30A 14V DC | 70A 14V DC (at 20°C 68°F) 50A 14V DC (at 85°C 185°F) |
| | Max. carrying current (initial) (coil applied voltage 14V DC, at 85°C 185°F, continuous) | N.O. side: 40A | N.O. side: 40A N.C. side: 30A | N.O. side: 40A |
| Min. switching load (resistive)*1 | 1A 14V DC (at 20°C 68°F) | | | |
| Insulated resistance (initial) | | Min. 20 MΩ (at 500V DC, Measurement at same location as "Dielectric strength" section.) | | |
| Dielectric strength (initial) | Between open contacts | 500 Vrms for 1 min. (Detection current: 10mA) | | |
| | Between contacts and coil | 500 Vrms for 1 min. (Detection current: 10mA) | | |
| Time characteristics (initial) | Operate (Set) time (at rated coil voltage) | Max. 15ms (at 20°C 68°F, without contact bounce time) | | |
| | Release (Reset) time (at rated coil voltage) | Max. 15ms (at 20°C 68°F, without contact bounce time) (Without diode) | | |
| Shock resistance | Functional | Min. 200 m/s ² {approx. 20G} (Half-wave pulse of sine wave: 11ms; detection time: 10μs) | | |
| | Destructive | Min. 1,000 m/s ² {approx. 100G} (Half-wave pulse of sine wave: 6ms) | | |
| Vibration resistance | Functional | 10 to 500 Hz, Min. 44.1m/s ² {approx. 4.5G} (Detection time: 10μs) | | |
| | Destructive | 10 to 2,000 Hz, Min. 44.1m/s ² {approx. 4.5G} Time of vibration for each direction; X, Y, Z direction: 4 hours | | |
| Expected life | Mechanical | Min. 10 ⁶ (at 120 cpm) | | |
| | Electrical (at rated switching capacity) | Flux tight: Min. 10 ⁵ , Sealed: Min. 5×10 ⁴ (Operating frequency: 2s ON, 2s OFF) | | |
| Conditions | Conditions for usage, transport and storage*2 | Standard; Ambient temperature: -40 to +85°C -40 to +185°F, Humidity: 5 to 85% R.H. (Please avoid icing or condensation) | | |
| | | Heat resistant; Ambient temperature: -40 to +125°C -40 to +257°F, Humidity: 5 to 85% R.H. (Please avoid icing or condensation) | | |
| Weight | | Approx. 33 g 1.16 oz | | |

Notes: *1. Depends on connection conditions. Also, this does not guarantee repeated switching. We recommend that you confirm operation under actual conditions.

*2. The upper operation ambient temperature limit is the maximum temperature that can satisfy the coil temperature rise value. For details, please refer to the "Automotive Relay Users Guide".

Please inquire our sales representative if you will be using the relay in a high temperature atmosphere (110°C 230°F)

2) Standard type (24 V coil voltage)

| Item | | Specifications | | |
|---|--------------------------------------|--------------------------------------|--|--------------------------------|
| Contact data | Contact arrangement | 1 Form A | 1 Form C | 1 Form A High contact capacity |
| | Contact resistance (initial) | Max. 15mΩ (By voltage drop 1A 6V DC) | | |
| | Contact material | Ag alloy | | |
| | Rated switching capacity (resistive) | 20A 28V DC | N.O. side: 20A 28V DC N.C. side: 10A 28V DC | 20A 28V DC |
| Max. carrying current (initial) (28V DC, at 85°C 185°F, continuous) | 20A | N.O. side: 20A N.C. side: 10A | 20A | |

Note: All other specifications are the same as those of standard type (12 V coil voltage)

3) Heat resistant type (12 V and 24 V coil voltage)

| Item | | Specifications | | | | | |
|--|--------------------------------------|--|--|--------------------------------|--|--|--------------------------------|
| | | 12V | | | 24V | | |
| Contact data | Contact arrangement | 1 Form A | 1 Form C | 1 Form A High contact capacity | 1 Form A | 1 Form C | 1 Form A High contact capacity |
| | Contact resistance (initial) | Max. 15mΩ (By voltage drop 1A 6V DC) | | | | | |
| | Contact material | Ag alloy | | | | | |
| | Rated switching capacity (resistive) | 40A 14V DC | N.O. side: 40A 14V DC N.C. side: 30A 14V DC | 40A 14V DC | 20A 28V DC | N.O. side: 20A 28V DC N.C. side: 10A 28V DC | 20A 28V DC |
| Max. carrying current (initial) (at 85°C 185°F, continuous)* | 50A 14V DC | N.O. side: 50A 14V DC N.C. side: 30A 14V DC | 45A 14V DC 50A 14V DC | 25A 28V DC | N.O. side: 25A 28V DC N.C. side: 10A 28V DC | 25A 28V DC | |

Notes: 1. All other specifications are the same as those of standard type (12 V coil voltage)

2. *Current value in which carry current is possible when the coil temperature is 180°C 356°F

REFERENCE DATA

CB RELAYS (Standard)

1. Allowable ambient temperature (Heat resistant and standard)

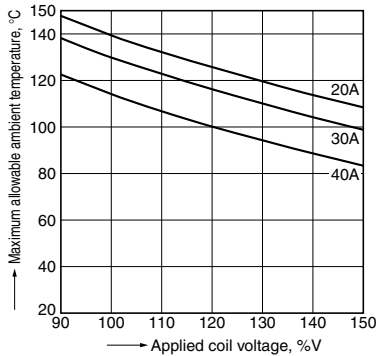

2. Max. switching capability (Resistive) (Standard)

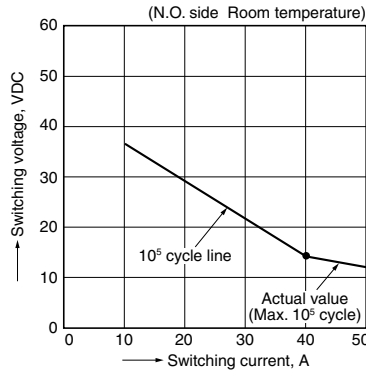

3. Ambient temperature and usable voltage range (Standard)

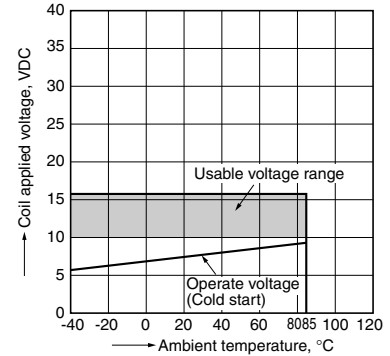

Notes:

- Maximum mean coil temperature: 180°C 356°F
- Curves are based on 1.4W (Nominal power consumption of the unsuppressed coil at nominal voltage)

4. Distribution of operate (set) and release (reset) voltage

Sample: CB1-P-12V, 42pcs.



5. Distribution of operate (set) and release (reset) time

Sample: CB1-P-12V, 42pcs.



6. Electrical life test (Motor free)

Sample: CB1F-12V, 5pcs.

Load: 25A 14V DC, motor free actual load

Operating frequency: ON 1s, OFF 9s

Ambient temperature: Room temperature

Circuit:



Change of operate (set) and release (reset) voltage



Change of contact resistance

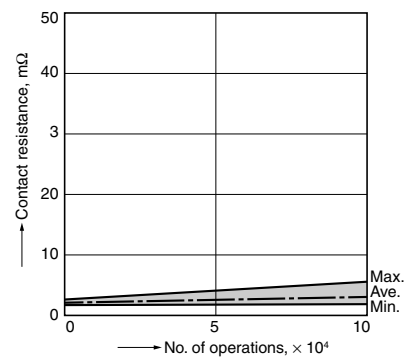

Load current waveform

Load; Inrush current: 80A, Steady current: 25A

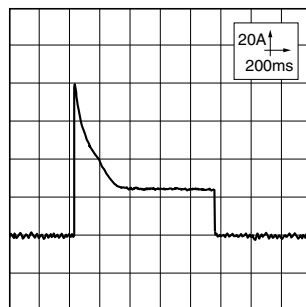

CB RELAYS (High contact capacity)

1. Allowable ambient temperature
(High resistant and high contact capacity)

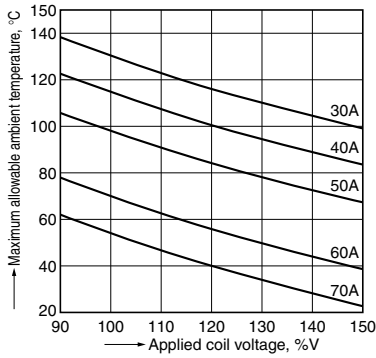

Notes:

- Maximum mean coil temperature: 180°C 356°F
- Curves are based on 1.4W (Nominal power consumption of the unsuppressed coil at nominal voltage)

2. Ambient temperature and usable voltage range
(High contact capacity and standard)

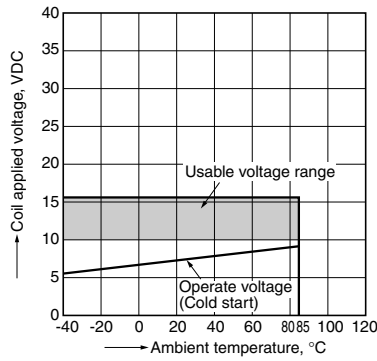

3. Distribution of operate (set) and release (reset) voltage
(Sample: CB1aHF-12V, 53pcs.)

Sample: CB1aHF-12V, 53pcs.

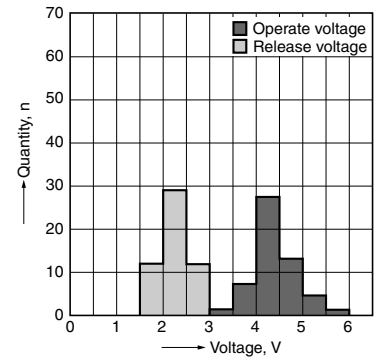

4. Distribution of operate and release time
Sample: CB1aHF-12V, 53pcs.

Sample: CB1aHF-12V, 53pcs.

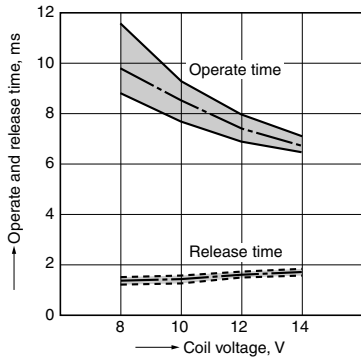

5. Contact resistance
Sample: CB1aHF-12V, 53pcs.

Sample: CB1aHF-12V, 53pcs.
(By voltage drop 1A 6V DC)

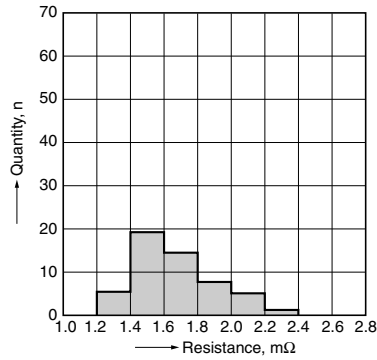

6. Electrical life test (Motor free)

Sample: CB1aH-12V, 3pcs.

Load: Inrush current: 64A, Steady current: 35A

Fan motor actual load (motor free) 12V DC

Operating frequency: ON 3s, OFF 7s

Ambient temperature: Room temperature

Circuit:

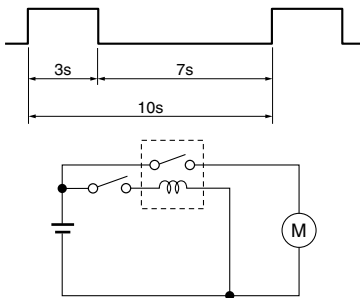

Change of operate (set) and release (reset) voltage

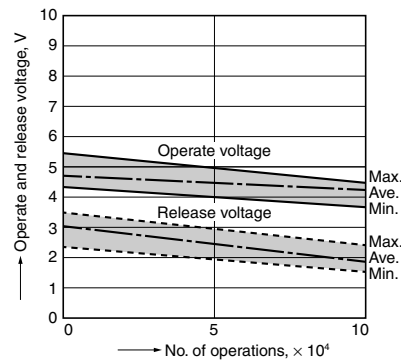

Change of contact resistance

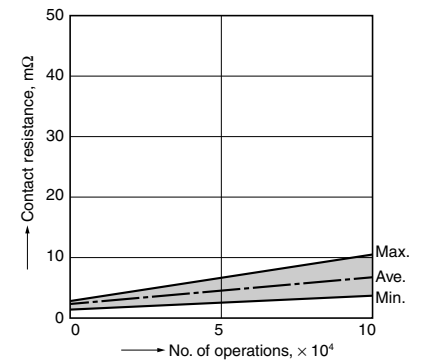

Load current waveform

Load; Inrush current: 64A, Steady current: 35A

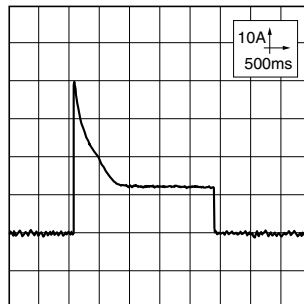

CB (ACB)

DIMENSIONS (mm inch)

The CAD data of the products with a **CAD** mark can be downloaded from: <http://industrial.panasonic.com/ac/e/>

1. PC board type

CAD



External dimensions

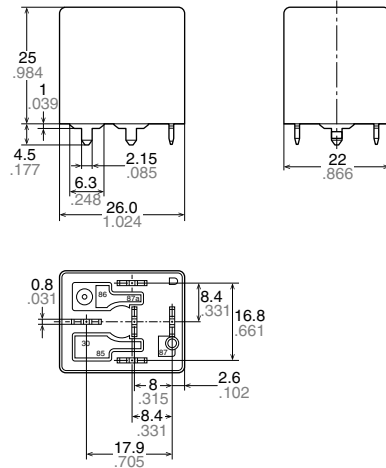

| Dimension: | Tolerance |
|-----------------------------|------------|
| Max. 1mm .039 inch: | ±0.1 ±.004 |
| 1 to 3mm .039 to .118 inch: | ±0.2 ±.008 |
| Min. 3mm .118 inch: | ±0.3 ±.012 |

Schematic (Bottom view)

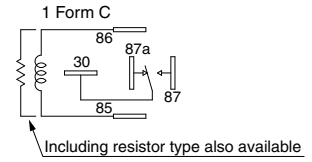
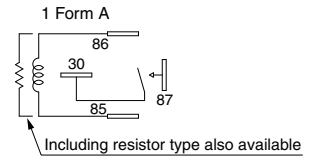

PC board pattern (Bottom view)



Tolerance: ±0.1 ±.004

2. Plug-in type

CAD



External dimensions



| Dimension: | Tolerance |
|-----------------------------|------------|
| Max. 1mm .039 inch: | ±0.1 ±.004 |
| 1 to 3mm .039 to .118 inch: | ±0.2 ±.008 |
| Min. 3mm .118 inch: | ±0.3 ±.012 |

Schematic (Bottom view)

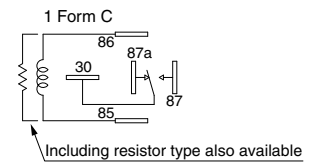
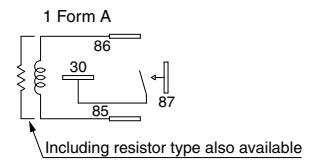

CB (ACB)

5.1 Form A high contact capacity (PC board type)

CAD



External dimensions



Schematic (Bottom view)



PC board pattern (Bottom view)



* Intervals between terminals is measured at A surface level.

Tolerance: $\pm 0.1 \pm 0.004$

| Dimension: | Tolerance |
|-----------------------------|---------------------|
| Max. 1mm .039 inch: | $\pm 0.1 \pm 0.004$ |
| 1 to 3mm .039 to .118 inch: | $\pm 0.2 \pm 0.008$ |
| Min. 3mm .118 inch: | $\pm 0.3 \pm 0.012$ |

NOTES

1. Soldering

Max. 350°C 662°F (solder temperature), within 3 seconds (soldering time)

The effect on the relay depends on the actual PC board used. Please verify the PC board to be used.

2. Usage, transport and storage conditions

1) Ambient temperature, humidity, and air pressure during usage, transport, and storage of the relay:

(1) Temperature: -40 to +85°C -40 to +185°F (Standard type)

-40 to +125°C -40 to +257°F (High heat-resistant type)

(2) Humidity: 2 to 85% RH (Avoid icing and condensation.)

(3) Air pressure: 86 to 106 kPa

The humidity range varies with the temperature. Use within the range indicated in the graph below.

[Temperature and humidity range for usage, transport, and storage]



For general cautions for use, please refer to the “Automotive Relay Users Guide”.

Please contact

Panasonic Corporation

Electromechanical Control Business Division

■ 1006, Oaza Kadoma, Kadoma-shi, Osaka 571-8506, Japan
industrial.panasonic.com/ac/e/

Panasonic[®]

©Panasonic Corporation 2017