

TPS-1

R19DS0069EJ0107

Rev.1.07

Jul 30th, 2018

Single Chip Interface Solution for PROFINET IO Devices

DESCRIPTION

The TPS-1 is a single-chip PROFINET interface component integrating a CPU, a 2-port switch supporting latest PROFINET specifications, the Ethernet PHYs and peripheral modules to interface to the application layer of any application building a PROFINET IO device.

The internal structure is designed to fulfill the requirements of the IRT protocol. The integrated components realize the complete interface functionality.

TPS-1 rounds off the basic technology range of PROFINET specifically for compact devices, and complies with PROFINET specification 2.3.

Detailed functions are described in the following user’s manual. Be sure to read this manual when you design your systems.

TPS-1 User’s Manual: Hardware (R19UH0081ED)

FEATURES

- Applications
 - Industrial Drives
 - Compact and modular Remote I/Os
- Product features
 - Integrated PROFINET IO CPU
 - Compliant with Conformance Class C
 - 2 Ethernet ports, 100 Mbps, full duplex
 - 2 integrated PHYs with an auto negotiation, auto crossover
 - Integrated IRT switch, 8 priority levels
 - Support RJ45 or fiber optic interfaces
 - Fiber optic diagnosis via I²C interface per port
 - IRT bridge-delay < 3 μs
 - Hardware support for PROFINET protocols including PTCP and LLDP
 - Versatile host interface for serial or parallel connection of external CPUs or local inputs/outputs
 - Small package(15 x 15 mm), 1mm ball pitch
- Application interface

The TPS-1 provides 48 General Purpose I/O (GPIO) pins that you can individually configure according to your specific application requirements.

 - 48 GPIO for digital I/Os
 - 8- or 16-bit parallel host interface
 - Serial host interface (SPI Slave)
 - 5GPIO for internal signals (e.g. LEDs)
 - Serial Flash interface

The TPS-1 interfaces to an application CPU via the internal shared memory either through the fast SPI slave interface or through the 8- or 16-bit parallel port.

ORDERING INFORMATION

Part No.	Application	Package
MC-10105F1-821-FNA-M1-A	TPS-1 PROFINET IO Device	FPBGA 196 Pins 15 x 15 mm

The information in this document is subject to change without notice. Before using this document, please confirm that this is the latest version.

Not all products and/or types are available in every country. Please check with our sales representative for availability and additional information.

INTERNAL BLOCK DIAGRAM

The block diagram shows the internal structure and main components of the TPS-1.

The additional serial boot Flash component, the oscillator and the physical adaptation for the Ethernet interfaces are not listed.

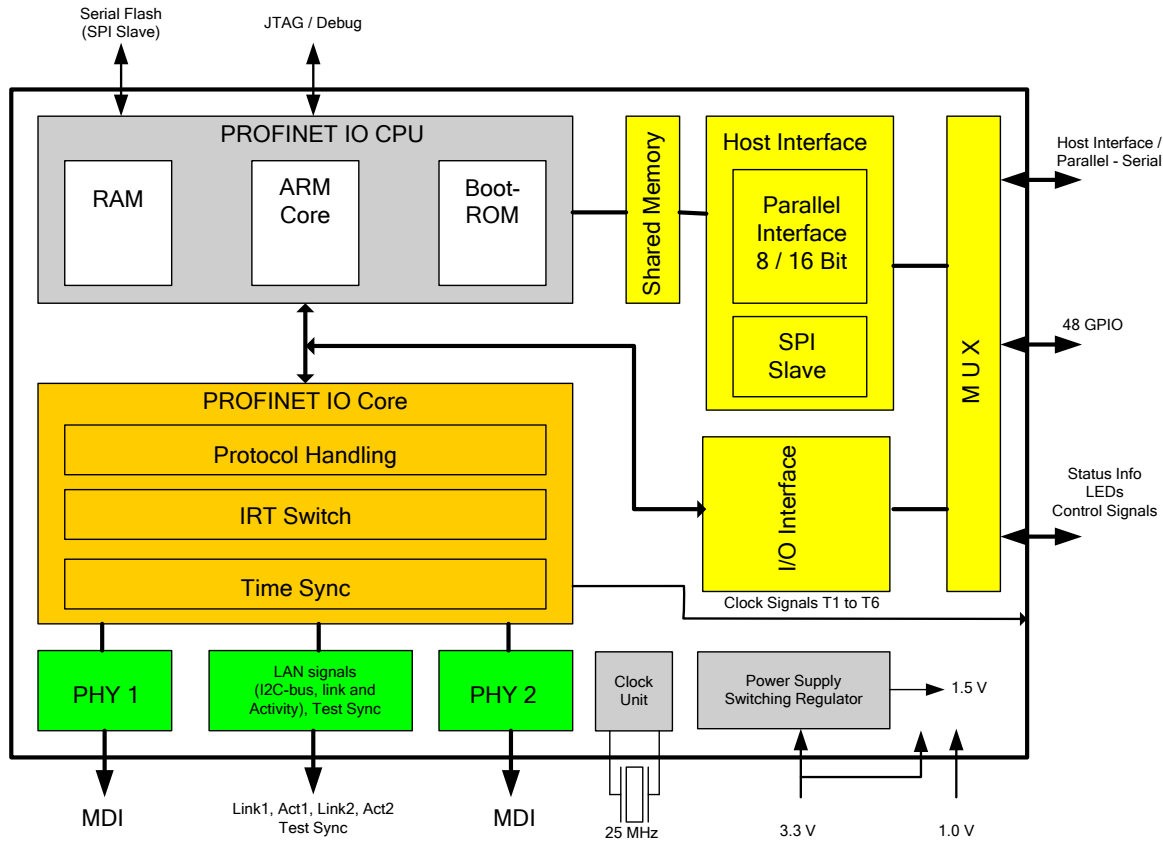

PIN IDENTIFICATION

SPI Master for Boot Flash ROM

CS_FLASH_OUT	: FW Flash: Chip Select
SPI3_SCLK_OUT	: FW Flash: CLOCK
SPI3_SRXD_IN	: FW Flash: Receive Data – MISO
SPI3_STXD_OUT	: FW Flash: Send Data – MOSI

Synchronisation signals

TEST_SYNC	: Clock signal for certification
T(6:1)	: Clock signals(6:1) (isochronous mode, IRT)

LED signals device status PROFINET IO

LED_BF_OUT	: Control LED „Bus Failure“
LED_SF_OUT	: Control LED „System Fail“
LED_READY_OUT	: Control LED „Device Ready“
LED_MT_OUT	: Control LED „Maintenance“

PHY Port 1 and 2

I2C_(2:1)_D_INOUT	: FO I ² C-Bus “Data”
SCLK_(2:1)_INOUT	:FO I ² C-Bus “Clock”
LINK_PHY(2:1)	: Ethernet LINK indication (up or down)
ACT_PHY(2:1)	: Activity Ethernet
P(2:1)_TX_P	: Ethernet Transmit Data (positive)
P(2:1)_TX_N	: Ethernet Transmit Data (negative)
P(2:1)_RX_P	: Ethernet Receive Data (positive)
P(2:1)_RX_N	: Ethernet Receive Data (negative)
P(2:1)_SD_P	: FO Signal Detect (positive)
P(2:1)_SD_N	: FO Signal Detect (negative)
P(2:1)_RD_P	: FO Receive Data (positive)
P(2:1)_RD_N	: FO Receive Data (negative)
P(2:1)_TD_OUT_P	: FO Transmit Data (negative)
P(2:1)_TD_OUT_N	: FO Transmit Data (positive)

P(2:1)_FX_EN_OUT : FO Transmitter enable (active high)

Oscillator

XCLK1 :Connection external oscillator (1) In, 25 MHz
XCLK2 :Connection external oscillator (2) Out, 25 MHz

JTAG – Interface

TM(1:0)	: Test Input (1:0)
TRSTN	: Test Reset
TMS	: Test Mode Select
TDO	: Test Data Output
TCK	: Test Clock
TDI	: Test Data Input

Reset / Test

RESETN	: TPS-1 Reset (Global Reset)
ATP	: Test pin for production test (n.c.)
EXTRES	: External reference resistor
TMC(2:1)	: Test Mode Control(2:1) (production test)
TEST_(2:1)_IN	: Test Pin (2:1) for HW test of TPS-1
TESTDOUT(7:5)	: Test Data Output (7:5) (High Speed Signals for PHY)

Host interface

WD_IN	: Watchdog input (from the Host)
WD_OUT	: Watchdog output (to the Host)
INT_OUT	: Interrupt output (to the Host)

Boot interface (serial)

UART6_TX	: Boot UART “Transmit Data“
UART6_RX	: Boot UART “Receive Data“
BOOT_1	: Forced Boot

Test signals for switching regulator

TEST(3:1) : Test Pin switching regulator (in combination with another test pins)

PHY supply voltages

VDD33ESD : Analog test supply, 3.3 V
 VDDQ_PECL_B(2:1) : PECL buffer power supply 3.3 V (Port(2:1))
 P(2:1)VDDARXTX : Analog Rx/Tx power supply 1.5 V – Port (2:1)
 VDDACB : Analog central power supply 3.3 V
 VSSAPLLCB : Analog central GND
 VDDAPLL : Analog central power supply 1.5 V

Pins for core PLL power supply

PLL_AGND : PLL analog GND (core PLL)
 PLL_AVDD : PLL analog 1.0 V (core PLL)

Pins for switching regulator

BVDD : Supply voltage for the switching regulator (3.3 V supply for the switching transistor)
 BGND : GND for switching regulator (please place bypass capacitor between analog power supply and GND).
 AVDD_REG : Analog VDD for regulator (3.3 V supply),smoothed voltage to feed the internal POR.
 AGND_REG : Analog GND switching regulator
 LX : 1.5 V output of the internal switching regulator
 FB : Feedback (regulator)

Configurable GPIOs

GPIO_(47:0) :GPIO pins

Alternate use of the GPIOs

LBU_WR_EN_IN : Write Enable
 LBU_READ_EN_IN : Read Enable
 LBU_CS_IN : Chip Select
 LBU_BE_(2:1)_IN : Byte Selection (1:low,2:high)
 LBU_READY_OUT : Ready Signal TPS-1
 LBU_DATA(15:0) : Data Bits
 LBU_A(13:0)_IN : Address Bits
 LBU_SEG(1:0)_IN : Segment select (2:1)
 HOST_RESET_IN : Reset Host SPI Interface
 HOST_SFRN_IN : Start new SPI Transfer
 HOST_SRXD_IN : SPI receive data
 HOST_SCLK_IN : SPI Clock
 HOST_STXD_OUT : SPI transmit data
 HOST_SHDR_OUT : Header recognized
 LOCAL_SCLK_OUT : SPI Clock
 LOCAL_SFRM_OUT : SPI chip select
 LOCAL_SRXD_IN : SPI receive data
 LOCAL_STXD_OUT : SPI transmit data

PIN CONFIGURATION

196-PIN PLASTIC BGA(15x15)

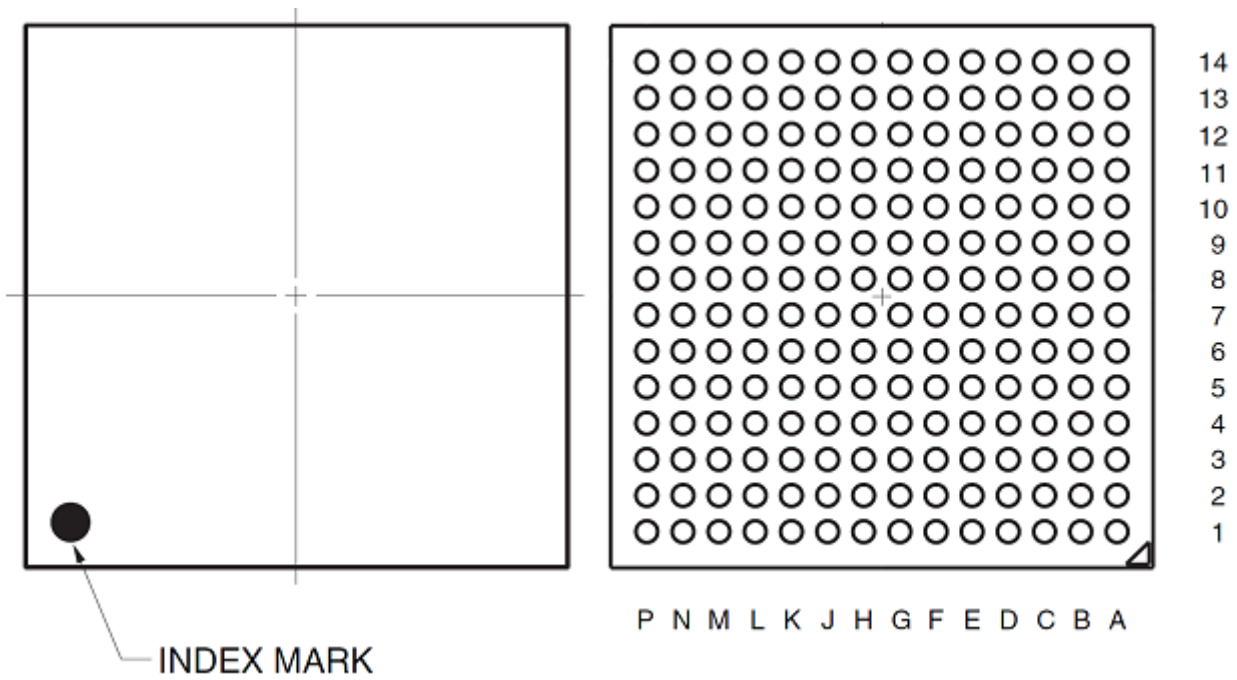

Pin	Designation	Pin	Designation	Pin	Designation	Pin	Designation
A1	GND	D8	TESTDOUT5	H1	LX	L8	TESTDOUT7
A2	VDD15	D9	TESTDOUT6	H2	VDD33	L9	PLL_AGND
A3	GPIO_7	D10	ACT_PHY1	H3	TEST1	L10	PLL_AVDD
A4	GPIO_4	D11	T6	H4	GPIO_26	L11	SCLK_2_INOUT
A5	P1_FX_EN_OUT	D12	AGND	H5	GPIO_25	L12	AGND
A6	P1_TD_OUT_N	D13	AGND	H6	GND	L13	AGND
A7	VDD15	D14	P1VDDARXTX	H7	GND	L14	P2VDDARXTX
A8	P1_SD_N	E1	TEST3	H8	GND	M1	GPIO_36
A9	P1_RD_N	E2	GPIO_16	H9	GND	M2	GPIO_35
A10	ACT_PHY2	E3	GPIO_17	H10	GND	M3	GPIO_37
A11	WD_IN	E4	GPIO_18	H11	T2	M4	GPIO_42
A12	RESETN	E5	GPIO_19	H12	ATP	M5	GPIO_45
A13	VDD15	E6	VDD10	H13	EXTRES	M6	GPIO_46
A14	GND	E7	VDD10	H14	VDDACB	M7	GPIO_47
B1	VDD33	E8	VDD10	J1	BVDD	M8	VDDQ_PECL_B2
B2	GPIO_9	E9	VDD10	J2	GND	M9	VDD15
B3	GPIO_8	E10	TMC1	J3	GPIO_28	M10	GND
B4	GPIO_5	E11	T5	J4	GPIO_27	M11	I2C_2_D_INOUT
B5	GPIO_1	E12	VDD33ESD	J5	TCK	M12	CS_FLASH_OUT
B6	P1_TD_OUT_P	E13	P1_RX_P	J6	GND	M13	SPI3_SRXD_IN
B7	GND	E14	P1_RX_N	J7	GND	M14	SPI3_STXD_OUT
B8	P1_SD_P	F1	FB	J8	GND	N1	VDD33
B9	P1_RD_P	F2	AVDD_REG	J9	GND	N2	GPIO_40
B10	LED_MT_OUT	F3	GPIO_22	J10	TM1	N3	GPIO_39
B11	LED_SF_OUT	F4	GPIO_21	J11	T1	N4	GPIO_41
B12	WD_OUT	F5	GPIO_20	J12	GND	N5	GPIO_44
B13	LED_BF_OUT	F6	VDD33	J13	P2_TX_P	N6	P2_TD_OUT_P
B14	VDD33	F7	GND	J14	P2_TX_N	N7	GND
C1	GPIO_12	F8	GND	K1	VDD15	N8	P2_SD_P
C2	GPIO_13	F9	GND	K2	GPIO_31	N9	P2_RD_P
C3	GPIO_6	F10	VDD33	K3	GPIO_29	N10	GND
C4	GPIO_3	F11	T4	K4	GPIO_30	N11	XCLK1
C5	GPIO_2	F12	VDD15	K5	TRSTN	N12	TEST_SYNC
C6	SCLK_1_INOUT	F13	P1_TX_P	K6	VDD10	N13	SPI3_SCLK_OUT
C7	VDD33	F14	P1_TX_N	K7	VDD10	N14	VDD33
C8	VDDQ_PECL_B1	G1	BGND	K8	VDD10	P1	GND
C9	I2C_1_D_INOUT	G2	AGND_REG	K9	VDD10	P2	VDD15
C10	LED_READY_OUT	G3	TEST2	K10	TMC2	P3	GPIO_38
C11	LINK_PHY2	G4	GPIO_24	K11	INT_OUT	P4	GPIO_43
C12	LINK_PHY1	G5	GPIO_23	K12	VDD15	P5	P2_FX_EN_OUT
C13	UART6_RX	G6	GND	K13	P2_RX_P	P6	P2_TD_OUT_N
C14	UART6_TX	G7	GND	K14	P2_RX_N	P7	VDD33
D1	GPIO_15	G8	GND	L1	GPIO_34	P8	P2_SD_N
D2	GPIO_14	G9	GND	L2	GPIO_32	P9	P2_RD_N
D3	GPIO_10	G10	GND	L3	GPIO_33	P10	VDD33
D4	GPIO_11	G11	T3	L4	TM0	P11	XCLK2
D5	GPIO_0	G12	GND	L5	TDI	P12	BOOT_1
D6	TEST_1_IN	G13	VSSAPLLCB	L6	TMS	P13	VDD15
D7	TEST_2_IN	G14	VDDAPLL	L7	TDO	P14	GND

Table of Contents

1.	Pin Functions	10
1.1.	List of Pin Functions	10
1.1.1.	Host Interface –Parallel Interface	10
1.1.2.	Host Interface –SPI slave Interface.....	10
1.1.3.	PROFINET IO Switch	11
1.1.4.	Integrated peripherals.....	12
1.2.	Pin Characteristics	17
2.	Electrical Specifications.....	21
2.1.	Absolute Maximum Ratings	21
2.2.	Operating Conditions	22
2.3.	Thermal Characteristics	23
2.4.	AC Characteristics	24
2.4.1.	Clock Timing	24
2.4.2.	I/O timing specification	25
2.4.2.1.	JTAG interface timing	26
2.4.2.2.	Parallel host interface timing diagrams.....	27
2.4.2.2.1.	Host read from TPS-1 with separate read/write line	27
2.4.2.2.2.	Host write to TPS-1 with separate read/write line.....	28
2.4.2.2.3.	Host read from TPS-1 with common read/write line	29
2.4.2.2.4.	Host write to TPS-1 with common read/write line.....	30
2.4.2.3.	SPI Slave Timing	31
2.4.3.	I2C-Bus timing definition	32
2.4.3.1.	PHY DC Specifications(100 BASE-TX)	33
2.4.3.2.	PHY AC Specifications (100BASE-TX)	34
2.4.4.	Power-up sequence	35
2.4.5.	Reset timing	36
3.	Package Drawing	37
4.	Recommended Soldering Conditions.....	38

List of Figures

Figure 2-1: Clock Waveforms.....	24
Figure 2-2: Input setup and hold waveforms	25
Figure 2-3: Output delay waveforms	25
Figure 2-4: Host read with separate read/write line	27
Figure 2-5: Host write with separate read/write line	28
Figure 2-6: Host read with common read/write line	29
Figure 2-7: Host write with common read/write line	30
Figure 2-8: SPI Slave Timing.....	30
Figure 2-9: I2C-Bus timing definition	31
Figure 2-10: PHY DC Specification	32
Figure 2-11: PHY AC Specification	33
Figure 2-12: Power-Up Sequence Timing Diagram.....	34
Figure 2-13: Reset Timing Diagram	35
Figure 3-1: 196-ball FPBGA Package Drawing.....	36

List of Tables

Table 1-1:	Parallel host interface	10
Table 1-2:	SPI host interface	10
Table 1-3:	Status signals of the ETHERNET interface (Port 1/Port2)	11
Table 1-4:	Signal lines 100Base-TX interface (Port 1/Port2)	11
Table 1-5:	Signal lines 100Base-FX interface (Port 1/Port2)	11
Table 1-6:	Additional TPS-1 pins	11
Table 1-7:	Boot Flash SPI Master Interface	12
Table 1-8:	General Purpose I/O pin functions	13
Table 1-9:	Status LEDs PROFINET IO	14
Table 1-10:	I2C interface lines	14
Table 1-11:	Boot UART lines	14
Table 1-12:	Interrupt signals	14
Table 1-13:	Watchdog signals	15
Table 1-14:	JTAG interface pin definition	15
Table 1-15:	Supply Voltage Circuitry	16
Table 1-16:	Signal characteristics	17
Table 2-1:	Absolute Maximum Ratings	21
Table 2-2:	Recommended Operating Conditions (supply voltages)	22
Table 2-3:	Recommended Operating Conditions (input / output level)	22
Table 2-4:	TPS-1 power consumption overview	22
Table 2-5:	Thermal Characteristics of the Package	23
Table 2-6:	Clock AC Characteristics (using a crystal)	24
Table 2-7:	Clock AC Characteristics (using an external oscillator)	23
Table 2-8:	Timing JTAG interface	26
Table 2-9:	Host read with separate read/write line	27
Table 2-10:	Host write with separate read/write line	28
Table 2-11:	Host read with common read/write line	29
Table 2-12:	Host write with common read/write line	30
Table 2-13:	SPI Slave Timing	30
Table 2-14:	Characteristics of the SCL and SDA lines	31
Table 2-15:	PHY DC Specification	32
Table 2-16:	PHY AC Timing	33
Table 2-17:	Signals for Power-Up	34
Table 2-18:	Signals for Reset Timing	35
Table 4-1:	Recommended soldering conditions	37

1. Pin Functions

1.1. List of Pin Functions

1.1.1. Host Interface –Parallel Interface

Table 1-1: Parallel host interface

Pin Name	I/O	Function	Remarks	Alternate Function
LBU_WR_EN_IN	I	Write Control	Active low (Intel mode)	GPIO_0
			0:write; 1:read (Motorola mode)	
LBU_READ_EN_IN	I	Read Control	Active low (Intel mode)	GPIO_1
			No function (Motorola mode)	
LBU_CS_IN	I	Chip Select		GPIO_2
LBU_BE_1_IN	I	Byte Select 1		GPIO_3
LBU_BE_2_IN	I	Byte Select 2		GPIO_4
LBU_READY_OUT	O	Ready Signal	Polarity configurable	GPIO_5
LBU_DATA(15:0)	I/O	data line 0 – 15		GPIO_(21:6)
LBU_A(13:0)_IN	I	Address lines 0 - 13		GPIO_(35:22)
LBU_SEG0_IN	I	Low Bit of the segment select	Page selection	GPIO_36
LBU_SEG1_IN	I	High Bit of the segment select	Page selection	GPIO_37

1.1.2. Host Interface –SPI slave Interface

Table 1-2: SPI host interface

Pin Name	I/O	Function	Remarks	Alternate Function
HOST_RESET_IN	I	Serial Reset	The SPI Slave interface can be reset by using this signal. (signal is active high)	GPIO_38
HOST_SFRN_IN	I	Serial Frame	The start of a new SPI transfer is signaled.	GPIO_39
HOST_SRXD_IN	I	Serial Data Input	MOSI (Master out Slave in)	GPIO_40
HOST_SCLK_IN	I	Serial Clock Input	Serial Clock driven by the SPI Master	GPIO_41
HOST_STXD_OUT	O	Serial Data Output	MISO (Master in Slave out)	GPIO_42
HOST_SHDR_OUT	O	Serial Header Information	header information available	GPIO_43

1.1.3. PROFINET IO Switch

Table 1-3: Status signals of the ETHERNET interface (Port 1/Port2)

Pin Name	I/O	Function	Remarks
LINK_PHY(2:1)	O	LINK ETHERNET	Active high
ACT_PHY(2:1)	O	Activity ETHERNET	Active high

Table 1-4: Signal lines 100Base-TX interface (Port 1/Port2)

Pin Name	I/O	Function	Remarks
P(2:1)_TX_P	O	Transmit data+	e.g. RJ45
P(2:1)_TX_N	O	Transmit data-	e.g. RJ45
P(2:1)_RX_P	I	Receive data+	e.g. RJ45
P(2:1)_RX_N	I	Receive data-	e.g. RJ45

Table 1-5: Signal lines 100Base-FX interface (Port 1/Port2)

Pin Name	I/O	Function	Remarks
I2C_(2:1)_D_INOUT	I/O	I ² C data line	e.g. SC-RJ
SCLK_(2:1)_INOUT	O	I ² C clock line	e.g. SC-RJ
P(2:1)_SD_P	I	Signal detect (differential, +)	e.g. SC-RJ
P(2:1)_SD_N	I	Signal detect (differential, -)	e.g. SC-RJ
P(2:1)_RD_N	I	Receive signal (differential, -)	e.g. SC-RJ
P(2:1)_RD_P	I	Receive signal (differential, +)	e.g. SC-RJ
P(2:1)_FX_EN_OUT	O	Transmitter enable (transceiver output)	e.g. SC-RJ
P(2:1)_TD_OUT_P	O	Transmit signal (differential, +)	e.g. SC-RJ
P(2:1)_TD_OUT_N	O	Transmit signal (differential, -)	e.g. SC-RJ

Table 1-6: Additional TPS-1 pins

Pin Name	I/O	Function	Remarks
ATP	AI/O (analog I/O)	Analog Test:	This signal is used for the manufacturing process. Pin is left open.
EXTRES	AI/O (analog I/O)	Reference resistor:	Connect via a resistor 12.4 kΩ / 1% to GND. This external resistor should be placed as close as possible to the chip. It must be terminated to analog GND.

1.1.4. Integrated peripherals

Table 1-7: Boot Flash SPI Master Interface

Pin Name	I/O	Function
CS_FLASH_OUT	O	SPI-Master-Interface Firmware Flash: Chip Select (TPS-1) – active low
SPI3_SCLK_OUT	O	SPI-Master-Interface Firmware Flash: CLOCK (TPS-1)
SPI3_SRXD_IN	I	SPI-Master-Interface Firmware Flash: Receive Data (TPS-1) – MISO
SPI3_STXD_OUT	O	SPI- Master-Interface Firmware Flash: Send Data (TPS-1) – MOSI

Table 1-8: General Purpose I/O pin functions

Pin Name	I/O	Function	Alternate Function
GPIO_0	I/O	General purpose digital I/O signal / Write Enable	LBU_WR_EN_IN
GPIO_1	I/O	General purpose digital I/O signal / Read Enable	LBU_READ_EN_IN
GPIO_2	I/O	General purpose digital I/O signal / Chip Select	LBU_CS_IN
GPIO_3	I/O	General purpose digital I/O signal / Byte Selection (low)	LBU_BE_1_IN
GPIO_4	I/O	General purpose digital I/O signal / Byte Selection (high)	LBU_BE_2_IN
GPIO_5	I/O	General purpose digital I/O signal / Ready Signal TPS-1 ^{Note2}	LBU_READY_OUT
GPIO_6	I/O	General purpose digital I/O signal / Data Bit	LBU_DATA0
GPIO_7	I/O	General purpose digital I/O signal / Data Bit	LBU_DATA1
GPIO_8	I/O	General purpose digital I/O signal / Data Bit	LBU_DATA2
GPIO_9	I/O	General purpose digital I/O signal / Data Bit	LBU_DATA3
GPIO_10	I/O	General purpose digital I/O signal / Data Bit	LBU_DATA4
GPIO_11	I/O	General purpose digital I/O signal / Data Bit	LBU_DATA5
GPIO_12	I/O	General purpose digital I/O signal / Data Bit	LBU_DATA6
GPIO_13	I/O	General purpose digital I/O signal / Data Bit	LBU_DATA7
GPIO_14	I/O	General purpose digital I/O signal / Data Bit	LBU_DATA8
GPIO_15	I/O	General purpose digital I/O signal / Data Bit	LBU_DATA9
GPIO_16	I/O	General purpose digital I/O signal / Data Bit	LBU_DATA10
GPIO_17	I/O	General purpose digital I/O signal / Data Bit	LBU_DATA11
GPIO_18	I/O	General purpose digital I/O signal / Data Bit	LBU_DATA12
GPIO_19	I/O	General purpose digital I/O signal / Data Bit	LBU_DATA13
GPIO_20	I/O	General purpose digital I/O signal / Data Bit	LBU_DATA14
GPIO_21	I/O	General purpose digital I/O signal / Data Bit	LBU_DATA15
GPIO_22	I/O	General purpose digital I/O signal / Address Bit	LBU_A0_IN
GPIO_23	I/O	General purpose digital I/O signal / Address Bit	LBU_A1_IN
GPIO_24	I/O	General purpose digital I/O signal / Address Bit	LBU_A2_IN
GPIO_25	I/O	General purpose digital I/O signal / Address Bit	LBU_A3_IN
GPIO_26	I/O	General purpose digital I/O signal / Address Bit	LBU_A4_IN
GPIO_27	I/O	General purpose digital I/O signal / Address Bit	LBU_A5_IN
GPIO_28	I/O	General purpose digital I/O signal / Address Bit	LBU_A6_IN
GPIO_29	I/O	General purpose digital I/O signal / Address Bit	LBU_A7_IN
GPIO_30	I/O	General purpose digital I/O signal / Address Bit	LBU_A8_IN
GPIO_31	I/O	General purpose digital I/O signal / Address Bit	LBU_A9_IN
GPIO_32	I/O	General purpose digital I/O signal / Address Bit	LBU_A10_IN
GPIO_33	I/O	General purpose digital I/O signal / Address Bit	LBU_A11_IN
GPIO_34	I/O	General purpose digital I/O signal / Address Bit	LBU_A12_IN
GPIO_35	I/O	General purpose digital I/O signal / Address Bit	LBU_A13_IN
GPIO_36	I/O	General purpose digital I/O signal / Segment select 1	LBU_SEG0_IN
GPIO_37	I/O	General purpose digital I/O signal / Segment select 2	LBU_SEG1_IN
GPIO_38	I/O	General purpose digital I/O signal / Reset Host SPI Interface	HOST_RESET_IN
GPIO_39	I/O	General purpose digital I/O signal / Start new SPI Transfer	HOST_SFRN_IN
GPIO_40	I/O	General purpose digital I/O signal / SPI receive data	HOST_SRXD_IN
GPIO_41	I/O	General purpose digital I/O signal / SPI Clock	HOST_SCLK_IN
GPIO_42	I/O	General purpose digital I/O signal / SPI transmit data	HOST_STXD_OUT
GPIO_43	I/O	General purpose digital I/O signal / Header recognized	HOST_SHDR_OUT
GPIO_44	I/O	General purpose digital I/O signal / SPI Clock	LOCAL_SCLK_OUT
GPIO_45	I/O	General purpose digital I/O signal / Start new SPI transfer	LOCAL_SFRM_OUT
GPIO_46	I/O	General purpose digital I/O signal / SPI receive data	LOCAL_SRXD_IN
GPIO_47	I/O	General purpose digital I/O signal / SPI transmit data	LOCAL_STXD_OUT

Notes: 1. You can only use one interface exclusively. It is not allowed to use e.g. the parallel and serial host interface at the same time.

- Notes: 2 The signal "LBU_READY_OUT" is designed to connect only to a single microcontroller. If you want to connect additional devices, you must add circuitry to realize the high-impedance state.
3. If the CPU does not have a READY input for connection to LBU_READY_OUT, customers can choose a wait time of 260 ns during each transfer cycle.
4. As soon as the signal HOST_SFRN_IN is set to "1", no more data is received on the RxD interface. Setting the signal is not allowed during an ongoing transfer.

Table 1-9: Status LEDs PROFINET IO

Pin Name(LED)	Color	I/O	State	Function
LED_BF_OUT	red	O		Bus Communication (active low):
			ON	No link status available.
			Flashing	Link status ok; no communication link to a PROFINET IO-Controller.
			OFF	The PROFINET IO-Controller has an active communication link to this PROFINET IO-Device.
LED_SF_OUT	red	O		System Fail (active low):
			ON	PROFINET diagnostic exists.
			OFF	No PROFINET diagnostic.
LED_MT_OUT	yellow	O		Maintenance required / demanded (active low)
			ON	PROFINET diagnostic alarm with maintenance state required or demanded.
			OFF	No diagnostic alarm with maintenance state required or demanded pending.
LED_READY_OUT	green	O		Device Ready (active low):
			OFF	TPS-1 has not started correctly.
			Flashing	TPS-1 is waiting for the synchronization of the Host CPU (firmware start is complete).
			ON	TPS-1 has started correctly.

Table 1-10: I²C interface lines

Pin Name	I/O	Function
I2C_(2:1)_D_INOUT	I/O	Fiber Optic Port(2:1) I ² C-Bus "Data"
SCLK_(2:1)_INOUT	O	Fiber Optic Port(2:1) I ² C-Bus "Clock"

Table 1-11: Boot UART lines

Pin Name	I/O	Function	
UART6_TX	O	Boot UART "Transmit data"	
UART6_RX	I	Boot UART "Receive data"	
BOOT_1	I	Forced Boot	
		Value	Function
		0x0	BROM: Boot from Boot Flash is enabled (normal operating mode).
		0x1	UART: Boot via UART is enabled.

Table 1-12: Interrupt signals

Pin Name	I/O	Function	Remark
INT_OUT	O	Interrupt output (to the Host)	Interrupt to host can be generated by a configurable set of internal TPS-1 events (active high).

Table 1-13: Watchdog signals

Pin Name	I/O	Function	Remark
WD_IN	I	Watchdog Input (from the Host)	This signal triggers the TPS-1 watchdog that monitors the Host CPU. A rising edge of this signal restarts the watchdog counter (active high).
WD_OUT	O	Watchdog Output (to the Host)	This signal is set when a watchdog trigger of the TPS-1 occurs (active low).

Table 1-14: JTAG interface pin definition

Pin Name	I/O	Function	Remark
TRSTN	I	Test Reset	JTAG Reset. Input: Reset signal of the target port. External pull-down (4.7K Ω to GND)
TMS	I	Test Mode Select	JTAG interface is activated from the debug unit. pull-up (4.7K Ω to V _{DD})
TDO	O	Test Data Output	can be left open
TCK	I	Test Clock	JTAG clock signal to the TPS-1. It is recommended that this pin is set to a defined state on the target board. External pull-up (4.7K Ω to V _{DD})
TDI	I	Test Data Input	External pull-up(4.7K Ω to V _{DD})

Table 1-15: Supply Voltage Circuitry

Pin Name	Function	Supply Voltage Generation
P(2:1)VDDARXTX	Analog port RX/TX power supply, 1.5 V (PHY port 2:1)	Must be generated from VDD15 via a filter.
VDDAPLL	Analog central power supply, 1.5 V (PHY)	
VDDACB	Analog central power supply, 3.3 V (PHY)	Must be generated from VDD33 via a filter.
VDD33ESD	Analog test power supply, 3.3 V (PHY)	
VSSAPLLCB	Analog central GND (PHY)	Must be generated from GND Core/IO via a filter or connected to GND Core/IO at the far end from TPS-1.
VDDQ_PECL_B(2:1)	PECL buffer power supply 3.3 V (port 1 and port 2)	
PLL_AGND	Analog Ground for the internal CPU clock generation	
PLL_AVDD	Power supply for the internal CPU clock generation (1.0V)	
GND	Digital GND	
AGND	Analog Ground for PHYs	
VDD33	Voltage Supply 3.3 V (external)	
VDD15	Voltage Supply 1.5 V from Switching Regulator or external	
VDD10	Voltage Supply 1.0 V (external)	
AGND_REG	Analog Ground for switching regulator.	
AVDD_REG	Supply voltage for regulator(3.3V supply), smoothed voltage to feed the internal POR.	
BGND	GND for switching regulator	Please place bypass capacitor between analog power supply and GND
BVDD	Supply voltage for the switching regulator (3.3V)	For the switching transistor

1.2. Pin Characteristics

Table 1-16: Signal characteristics

Pin Name	I/O	Input type	Output type	Pull up / down		Capacity load (pF)	Drive capability	
				internal	external		I _{OH}	I _{OL}
SPI-Master for Flash ROM								
CS_FLASH_OUT	O	-	3.3V CMOS	-		30	6 mA	6 mA
SPI3_SCLK_OUT	O	-	3.3V CMOS	-		30	6 mA	6 mA
SPI3_SRXD_IN	I	Schmitt	3.3V CMOS	-		-	-	-
SPI3_STXD_OUT	O	-	3.3V CMOS	-		30	6 mA	6 mA
Synchronization signals								
TEST_SYNC	O	-	3.3V CMOS	-		30	6 mA	6 mA
T1	O	-	3.3V CMOS	-		30	6 mA	6 mA
T2	O	-	3.3V CMOS	-		30	6 mA	6 mA
T3	O	-	3.3V CMOS	-		30	6 mA	6 mA
T4	O	-	3.3V CMOS	-		30	6 mA	6 mA
T5	O	-	3.3V CMOS	-		30	6 mA	6 mA
T6	O	-	3.3V CMOS	-		30	6 mA	6 mA
LED signals for PROFINET IO status								
LED_BF_OUT	O	-	3.3V CMOS	-		30	6 mA	6 mA
LED_SF_OUT	O	-	3.3V CMOS	-		30	6 mA	6 mA
LED_READY_OUT	O	-	3.3V CMOS	-		30	6 mA	6 mA
LED_MT_OUT	O	-	3.3V CMOS	-		30	6 mA	6 mA
PHY Port 1								
I2C_1_D_INOUT	I/O	Schmitt	3.3V CMOS	-		30	6 mA	6 mA
SCLK_1_INOUT	I/O	Schmitt	3.3V CMOS	-		30	6 mA	6 mA
LINK_PHY1	O	-	3.3V CMOS	-		30	6 mA	6 mA
ACT_PHY1	O	-	3.3V CMOS	-		30	6 mA	6 mA
P1_TX_P	O	-	Analog	-		-	-	-
P1_TX_N	O	-	Analog	-		-	-	-
P1_RX_P	I	-	Analog	-		-	-	-
P1_RX_N	I	-	Analog	-		-	-	-
P1_SD_P	I	PECL	-	-		-	-	-
P1_SD_N	I	PECL	-	-		-	-	-
P1_RD_P	I	PECL	-	-		-	-	-
P1_RD_N	I	PECL	-	-		-	-	-
P1_TD_OUT_P	O	-	3.3V CMOS	-		-	12 mA	12 mA
P1_TD_OUT_N	O	-	3.3V CMOS	-		-	12 mA	12 mA
P1_FX_EN_OUT	O	-	3.3V CMOS	-		30	12 mA	12 mA
PHY Port 2								
I2C_2_D_INOUT	I/O	Schmitt	3.3V CMOS	-		30	6 mA	6 mA
SCLK_2_INOUT	I/O	Schmitt	3.3V CMOS	-		30	6 mA	6 mA
LINK_PHY2	O	-	3.3V CMOS	-		30	6 mA	6 mA
ACT_PHY2	O	-	3.3V CMOS	-		30	6 mA	6 mA
P2_TX_P	O	-	Analog	-		-	-	-
P2_TX_N	O	-	Analog	-		-	-	-
P2_RX_P	I	-	Analog	-		-	-	-
P2_RX_N	I	-	Analog	-		-	-	-
P2_SD_P	I	PECL	-	-		-	-	-
P2_SD_N	I	PECL	-	-		-	-	-
P2_RD_P	I	PECL	-	-		-	-	-
P2_RD_N	I	PECL	-	-		-	-	-
P2_TD_OUT_P	O	-	3.3V CMOS	-		-	12 mA	12 mA

Pin Name	I/O	Input type	Output type	Pull up / down	Pull up / down	Capacity load (pF)	Drive capability	
				internal	external		I _{OH}	I _{OL}
P2_TD_OUT_N	O	-	3.3V CMOS	-		-	12 mA	12 mA
P2_FX_EN_OUT	O	-	3.3V CMOS	-		30	12 mA	12 mA
Oscillator								
XCLK1	I	Osc. in	-	-		-	-	-
XCLK2	O	Osc. Out	-	-		25	6 mA	6 mA
JTAG – Interface								
TM0	I	Schmitt		Pull-up 50 kΩ	Pull-down 1 kΩ	-	-	-
TM1	I	Schmitt	-		Pull-down 1 kΩ	-	-	-
TRSTN	I	Schmitt	3.3V CMOS	-	Pull-down 4.7 kΩ	-	-	-
TMS	I	Schmitt	3.3V CMOS	-	Pull-up 4.7 kΩ	-	-	-
TDO	O	-	3.3V CMOS	-	-	30	6 mA	6 mA
TCK	I	Schmitt	3.3V CMOS	-	Pull-up 4.7 kΩ	-	-	-
TDI	I	Schmitt	3.3V CMOS		Pull-up 4.7 kΩ	-	-	-
Reset / Test								
RESETN	I	Schmitt	3.3V CMOS	-		-	-	-
ATP	IO		-	-		-	-	-
EXTRES	IO	Analog	-	-		-	-	-
TMC1	I		3.3V CMOS	pull-down (50 kΩ)		-	-	-
TMC2	I		3.3V CMOS	pull-down (150 kΩ)		-	-	-
TEST_1_IN	I	Schmitt	3.3V CMOS	pull-down (50 kΩ)		-	-	-
TEST_2_IN	I	Schmitt	3.3V CMOS	pull-down (50 kΩ)		-	-	-
TESTDOUT5	O		3.3V CMOS	-		-	12 mA	12 mA
TESTDOUT6	O		3.3V CMOS	-		-	12 mA	12 mA
TESTDOUT7	O		3.3V CMOS	-		-	12 mA	12 mA
Host interface								
WD_IN	I	Schmitt	3.3V CMOS	-		-	-	-
WD_OUT	O	-	3.3V CMOS	-		30	6 mA	6 mA
INT_OUT	O	-	3.3V CMOS	-		30	6 mA	6 mA
Boot interface (serial)								
UART6_TX	O	-	3.3V CMOS	-		30	6 mA	6 mA
UART6_RX	I	Schmitt	3.3V CMOS	-		-	6 mA	6 mA
BOOT_1	I	Schmitt	-	pull-down (50 kΩ)		-	-	-
Test signals – switching regulator								
TEST1	I	-	-	-	see note 1	-	-	-
TEST2	I	-	-	-	see note 1	-	-	-
TEST3	I	-	-	-	see note 1	-	-	-
Power Supplies								
GND	-	-	-	-		-	-	-
VDD33	-	-	-	-		-	-	-

Pin Name	I/O	Input type	Output type	Pull up / down	Pull up / down	Capacity load (pF)	Drive capability	
				internal	external		I _{OH}	I _{OL}
VDD15	-	-	-	-		-	-	-
VDD10	-	-	-	-		-	-	-
VDD33ESD	-	-	-	-		-	-	-
VDDAPLL	-	-	-	-		-	-	-
VDDACB	-	-	-	-		-	-	-
VDDQ_PECL_B1	I	-	-	-		-	-	-
VDDQ_PECL_B2	I	-	-	-		-	-	-
P1VDDARXTX	I	-	-	-		-	-	-
P2VDDARXTX	I	-	-	-		-	-	-
VSSAPLLCB	-	-	-	-		-	-	-
LX	O	-	-	-		-	-	-
FB (1.5V analog)	I	-	-	-		-	-	-
AVDD_REG	I	-	-	-		-	-	-
BGND	-	-	-	-		-	-	-
AGND_REG	-	-	-	-		-	-	-
BVDD	-	-	-	-		-	-	-
PLL_AGND	I	-	-	-		-	-	-
PLL_AVDD	I	-	-	-		-	-	-
GPIOs								
GPIO_00	I/O	Schmitt	3.3V CMOS	-	see note 2	30	6 mA	6mA
GPIO_01	I/O	Schmitt	3.3V CMOS	-	see note 2	30	6 mA	6mA
GPIO_02	I/O	Schmitt	3.3V CMOS	-	see note 2	30	6 mA	6mA
GPIO_03	I/O	Schmitt	3.3V CMOS	-	see note 2	30	6 mA	6mA
GPIO_04	I/O	Schmitt	3.3V CMOS	-	see note 2	30	6 mA	6mA
GPIO_05	I/O	Schmitt	3.3V CMOS	-	see note 2	50	9 mA	9 mA
GPIO_06	I/O	Schmitt	3.3V CMOS	-	see note 2	50	9 mA	9 mA
GPIO_07	I/O	Schmitt	3.3V CMOS	-	see note 2	50	9 mA	9 mA
GPIO_08	I/O	Schmitt	3.3V CMOS	-	see note 2	50	9 mA	9 mA
GPIO_09	I/O	Schmitt	3.3V CMOS	-	see note 2	50	9 mA	9 mA
GPIO_10	I/O	Schmitt	3.3V CMOS	-	see note 2	50	9 mA	9 mA
GPIO_11	I/O	Schmitt	3.3V CMOS	-	see note 2	50	9 mA	9 mA
GPIO_12	I/O	Schmitt	3.3V CMOS	-	see note 2	50	9 mA	9 mA
GPIO_13	I/O	Schmitt	3.3V CMOS	-	see note 2	50	9 mA	9 mA
GPIO_14	I/O	Schmitt	3.3V CMOS	-	see note 2	50	9 mA	9 mA
GPIO_15	I/O	Schmitt	3.3V CMOS	-	see note 2	50	9 mA	9 mA
GPIO_16	I/O	Schmitt	3.3V CMOS	-	see note 2	50	9 mA	9 mA
GPIO_17	I/O	Schmitt	3.3V CMOS	-	see note 2	50	9 mA	9 mA
GPIO_18	I/O	Schmitt	3.3V CMOS	-	see note 2	50	9 mA	9 mA
GPIO_19	I/O	Schmitt	3.3V CMOS	-	see note 2	50	9 mA	9 mA
GPIO_20	I/O	Schmitt	3.3V CMOS	-	see note 2	50	9 mA	9 mA
GPIO_21	I/O	Schmitt	3.3V CMOS	-	see note 2	50	9 mA	9 mA
GPIO_22	I/O	Schmitt	3.3V CMOS	-	see note 2	30	6 mA	6 mA
GPIO_23	I/O	Schmitt	3.3V CMOS	-	see note 2	30	6 mA	6 mA
GPIO_24	I/O	Schmitt	3.3V CMOS	-	see note 2	30	6 mA	6 mA
GPIO_25	I/O	Schmitt	3.3V CMOS	-	see note 2	30	6 mA	6 mA
GPIO_26	I/O	Schmitt	3.3V CMOS	-	see note 2	30	6 mA	6 mA
GPIO_27	I/O	Schmitt	3.3V CMOS	-	see note 2	30	6 mA	6 mA
GPIO_28	I/O	Schmitt	3.3V CMOS	-	see note 2	30	6 mA	6 mA
GPIO_29	I/O	Schmitt	3.3V CMOS	-	see note 2	30	6 mA	6 mA

Pin Name	I/O	Input type	Output type	Pull up / down	Pull up / down	Capacity load (pF)	Drive capability	
				<i>internal</i>	<i>external</i>		<i>I_{OH}</i>	<i>I_{OL}</i>
GPIO_30	I/O	Schmitt	3.3V CMOS	-	see note 2	30	6 mA	6 mA
GPIO_31	I/O	Schmitt	3.3V CMOS	-	see note 2	30	6 mA	6 mA
GPIO_32	I/O	Schmitt	3.3V CMOS	-	see note 2	30	6 mA	6 mA
GPIO_33	I/O	Schmitt	3.3V CMOS	-	see note 2	30	6 mA	6 mA
GPIO_34	I/O	Schmitt	3.3V CMOS	-	see note 2	30	6 mA	6 mA
GPIO_35	I/O	Schmitt	3.3V CMOS	-	see note 2	30	6 mA	6 mA
GPIO_36	I/O	Schmitt	3.3V CMOS	-	see note 2	30	6 mA	6 mA
GPIO_37	I/O	Schmitt	3.3V CMOS	-	see note 2	30	6 mA	6 mA
GPIO_38	I/O	Schmitt	3.3V CMOS	-	see note 2	30	6 mA	6 mA
GPIO_39	I/O	Schmitt	3.3V CMOS	-	see note 2	30	6 mA	6 mA
GPIO_40	I/O	Schmitt	3.3V CMOS	-	see note 2	30	6 mA	6 mA
GPIO_41	I/O	Schmitt	3.3V CMOS	-	see note 2	30	6 mA	6 mA
GPIO_42	I/O	Schmitt	3.3V CMOS	-	see note 2	30	6 mA	6 mA
GPIO_43	I/O	Schmitt	3.3V CMOS	-	see note 2	30	6 mA	6 mA
GPIO_44	I/O	Schmitt	3.3V CMOS	-	see note 2	30	6 mA	6 mA
GPIO_45	I/O	Schmitt	3.3V CMOS	-	see note 2	30	6 mA	6 mA
GPIO_46	I/O	Schmitt	3.3V CMOS	-	see note 2	30	6 mA	6 mA
GPIO_47	I/O	Schmitt	3.3V CMOS	-	see note 2	30	6 mA	6 mA

Note 1: These pins (TEST(3:1)) must not be left open. For the required connection please consult the TPS-1 User Manual.

Note 2: The GPIO pins GPIO_00 to GPIO_47 can be configured as diagnosis input lines (local IO mode). The GPIO pins are configured into groups of 8 bit. Unused diagnosis inputs must have a pull-down or pull-up resistor (depending on customer's design). A missing termination can cause undefined diagnosis.

Note 3: Generally unused GPIO pins should be pulled up (10 kΩ to VDD33). From PROFINET stack version V1.4 onwards all unused GPIOs should be left open, because the stack will configure them to outputs. This does not apply to pins handled in note 2.

Abbreviations:

I	Input
O	Output
I/O	Input/Output

2. Electrical Specifications

2.1. Absolute Maximum Ratings

Table 2-1: Absolute Maximum Ratings

Parameter		Symbol	Rating	Unit
Power supply for core		VDD10	-0.5 to +1.4	V
Power supply for IO		VDD33	-0.5 to +4.6	V
Power supply for PHYs		VDD15	-0.5 to +2.0	V
Analog power supply for PLL		PLL_AVDD	-0.5 to +1.4	V
Analog central 3.3V supply for PHYs		VDDACB	-0.5 to +4.6	V
Analog central 1.5V supply for PHYs		VDDAPLL	-0.5 to +2.0	V
Analog Rx/Tx port power supply		P(2:1)VDDARXTX	-0.5 to +2.0	V
PECL buffer power supply PHY 1		VDDQ_PECL_B1	-0.5 to +4.6	V
PECL buffer power supply PHY 2		VDDQ_PECL_B2	-0.5 to +4.6	V
Analog test supply		VDD33ESD	-0.5 to +4.6	V
Input voltage	3.3V CMOS $V_I < V_{DD} + 0.5V$	V_I	-0.5 to +4.6	V
Operating temperature		T_J	-40 to + 125	°C
Storage temperature		T_{STG}	-65 to + 150	°C

Caution: Product quality may suffer if the absolute maximum rating is exceeded even momentarily for any parameter. That is, the absolute maximum ratings are rated values at which the product is on the verge of suffering physical damage, and therefore the product must be used under conditions that ensure that the absolute maximum ratings are not exceeded. The ratings and conditions indicated for DC characteristics and AC characteristics represent the quality assurance range during normal operation.

2.2. Operating Conditions

Table 2-2: Recommended Operating Conditions (supply voltages)

Parameter	Symbol	MIN.	TYP.	MAX.	Unit
Power supply for core (digital)	VDD10	0.9	1.0	1.1	V
Power supply for IO (digital)	VDD33	3.0	3.3	3.6	V
Power supply for PHYs (digital)	VDD15	1.35	1.5	1.65	V
Analog power supply for PHYs	AVDD_REG	3.0	3.3	3.6	V
Analog central 3.3V supply for PHYs	VDDACB	3.0	3.3	3.6	V
Analog central 1.5V supply for PHYs	VDDAPLL	1.35	1.5	1.65	V
PECL buffer power supply PHY 1	VDDQ_PECL_B1	3.0	3.3	3.6	V
PECL buffer power supply PHY 2	VDDQ_PECL_B2	3.0	3.3	3.6	V
Analog test supply	VDD33ESD	3.0	3.3	3.6	V
Analog power supply for PLL	PLL_AVDD	0.9	1.0	1.1	V
Ambient temperature	T _A	-40		+85	°C

Table 2-3: Recommended Operating Conditions (input / output level)

Parameter		Symbol	Test Conditions	MIN.	TYP.	MAX.	Unit
Output voltage high	3.3V CMOS	V _{OH}	I _{OH} = 0 mA	VDD33 – 0.1V			V
			nominal output current	2.4			V
Output voltage low	3.3V CMOS	V _{OL}	I _{OL} = 0 mA			0.1	V
			nominal output current			0.4	V
Input voltage high	3.3V CMOS	V _{IH}		2		VDD33	V
	3.3V PECL		Difference to VDDQ_PECL_B(2:1)	-0.880		1.165	V
Input voltage low	3.3V CMOS	V _{IL}		0		0.8	V
	3.3V PECL		Difference to VDDQ_PECL_B(2:1)	-1.474		-1.880	V
Positive trigger voltage	3.3V buffer	V _P		1.2		2.4	V
Negative trigger voltage	3.3V buffer	V _N		0.6		1.8	V
Hysteresis voltage	3.3V buffer	V _H		0.3		1.5	V

Table 2-4: TPS-1 power consumption overview

Parameter	MIN.	TYP.	MAX.	Unit
Power consumption	1.0 V		300	mW
	1.5V		240	mW
	3.3V		363	mW
	Total:		800 ^{Note}	903

Note: The power consumption of the TPS-1 is approx. 800mW (average).

2.3. Thermal Characteristics

Table 2-5: Thermal Characteristics of the Package

Parameter	Symbol	Airflow (m/s)				Unit
		0	0.2	1	2	
Thermal resistance junction to ambient ^{Note1}	Θ_{ja}	21.99	20.91	18.86	17.80	K/W
Thermal resistance junction to top center of the package surface ^{Note1}	Ψ_{jt}	0.12	0.17	0.31	0.37	K/W
Thermal resistance junction to case ^{Note2}	Θ_{jc}	7.38				K/W

Note 1. The parameters are valid, if no heat sink is used and PCB with 4 layers and massive ground and power planes.

2. The parameter is valid, if a heat sink is used.

2.4. AC Characteristics

2.4.1. Clock Timing

Table 2-6: Clock AC Characteristics (using a crystal)

Parameter	Symbol	MIN.	TYP.	MAX.	Unit
Oscillator clock frequency (XCLK1, Pin N11) XCLK2, Pin P11) ^{Note 1}	f_C	-	25	-	MHz
Frequency tolerance	f_{tol}	-50 ppm	-	+ 50 ppm	
EXTAL clock cycle time	T_{EXcyc}	-	40	-	ns
EXTAL clock rising time ^{Note 2}	t_{EXr}	0	-	4	ns
EXTAL clock falling time ^{Note 2}	t_{EXf}	0	-	4	ns
Input capacity (incl. package), XCLK1, N11	C_{IN}	-	4.2	-	pF
Output capacity (incl. package), XCLK2, P11	C_{OUT}	3	4	5	pF
High level input voltage	V_{IH}	2.0	-		V
Low level input voltage	V_{IL}	-	-	0.8	V
JTAG clock frequency	-	-	-	20	MHz

- Notes: 1. See TPS-1 User's Manual: Hardware () for recommended XTAL
 2. Input voltage rising from 10% to 90% or falling from 90% to 10% of its nominal value.

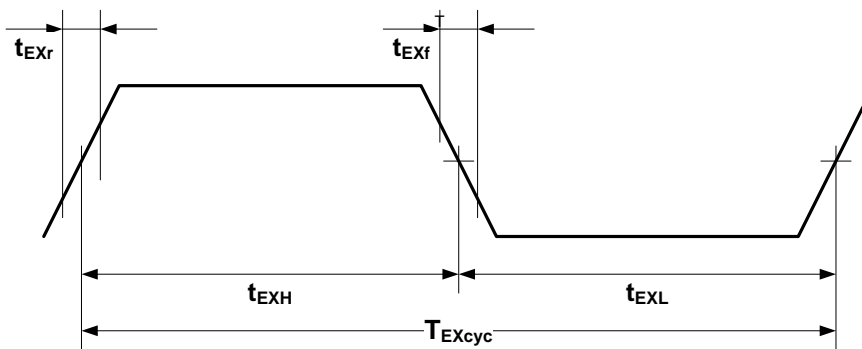

Figure 2-1: Clock Waveforms

Table 2-7: Clock AC Characteristics (using an external oscillator)

Parameter	Symbol	MIN.	TYP.	MAX.	Unit
External clock source frequency	f_{IN}	-	25	-	MHz
Frequency tolerance ^{Note 1}	f_{tol}	-50 ppm	-	+ 50 ppm	
XCLK1 high level voltage	V_{IH}	2	3.3	VDDACB	V
XCLK1 low level voltage	V_{IL}	0	-	0.8	V
XCLK1 rise or fall time	t_{RFC}	0	1	4	ns
XCLK1 high or low time ^{Note 2}	t_w	16	20	24	pF
XCLK1 jitter tolerance	t_{JIT}	-	20	-	ps (RMS)
XCLK1 duty cycle	DuCy	40	50	60	%

- Notes: 1. The specified frequency tolerance must be maintained over all lifetime and temperature.
 2. t_w was calculated at $f_{IN(TYP)}=25$ MHz, e.g. $t_{w(MIN)} = 10 * (DuCy_{(MIN)} / f_{IN(TYP)})$

2.4.2. I/O timing specification

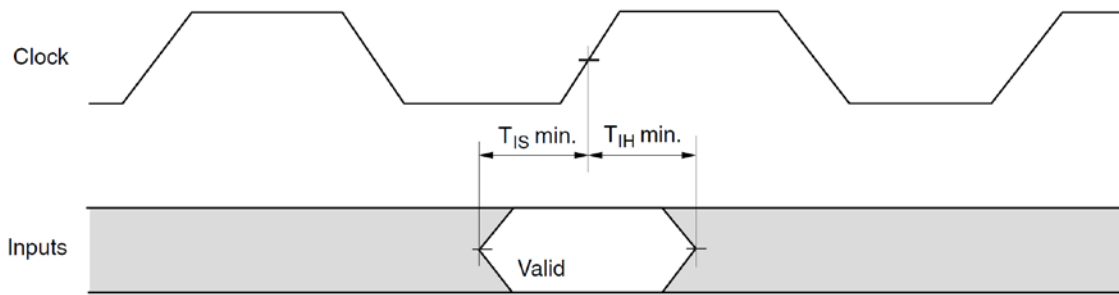

Figure 2-2: Input setup and hold waveforms

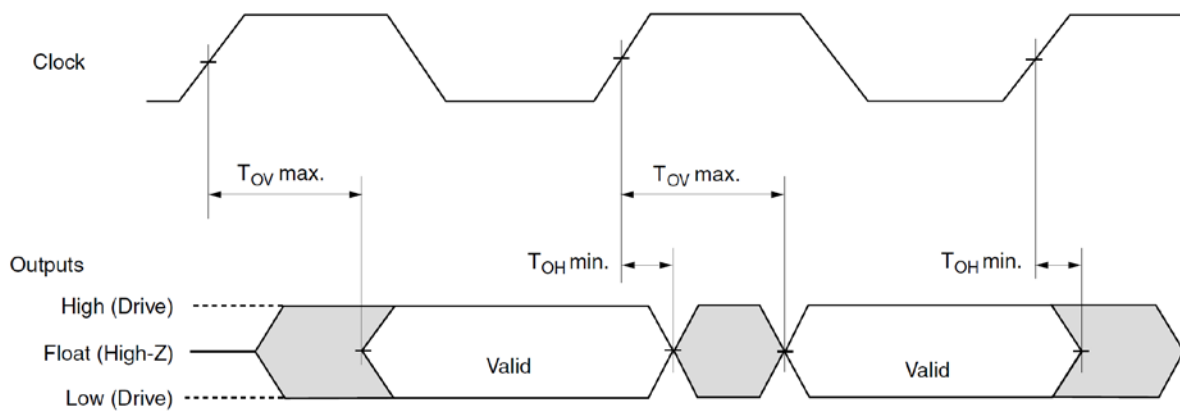

Figure 2-3: Output delay waveforms

2.4.2.1. JTAG interface timing

Table 2-8: Timing JTAG interface

Signal	Input		Output		Unit	Clock	Notes
	Setup time (T_{IS} min.)	Hold time (T_{IH} min.)	Valid delay (T_{OV} max.)	Hold time (T_{OH} min.)			
TRSTN	8	0			ns	TCK	
TMS	8	0			ns	TCK	
TDI	8	0			ns	TCK	
TCK	-	-	-	-	-	-	Note 2
TDO			10	2	ns	TCK	Note 1

Note 1: Minimum hold time is measured with 10 pF load and maximum valid Delay is measured with 30 pF load.
 Note 2: For TCK a maximum speed of 20 MHz is allowed.

2.4.2.2. Parallel host interface timing diagrams

2.4.2.2.1. Host read from TPS-1 with separate read/write line

(LBU_READY_OUT active low)

$T_A = -40$ to $+85^\circ\text{C}$; $V_{DD15} = 1.35\text{ V} \sim 1.65\text{ V}$; $V_{DD33} = 3.0\text{ V} \sim 3.6\text{ V}$

Table 2-9: Host read with separate read/write line

Parameter	Symbol	Condition	MIN.	MAX.	Unit
Chip select asserted to read pulse asserted delay	t_{CSRS}	-	0	-	ns
Address valid to read pulse asserted setup time	t_{ARS}	-	0	-	ns
Read pulse asserted to ready enabled delay	t_{RRE}	-	5	12	ns
Read pulse asserted to data enable delay	t_{RDE}	-	5	12	ns
Ready asserted to data valid delay	t_{RTD}	-	-	5	ns
Read pulse deasserted to chip select deasserted delay	t_{RCSH}	-	0	-	ns
Address valid to read pulse deasserted hold time	t_{RHA}	-	0	-	ns
Data valid/enable to read pulse deasserted hold time	t_{RDH}	-	0	12	ns
Read recovery time	t_{RR}	-	25	-	ns

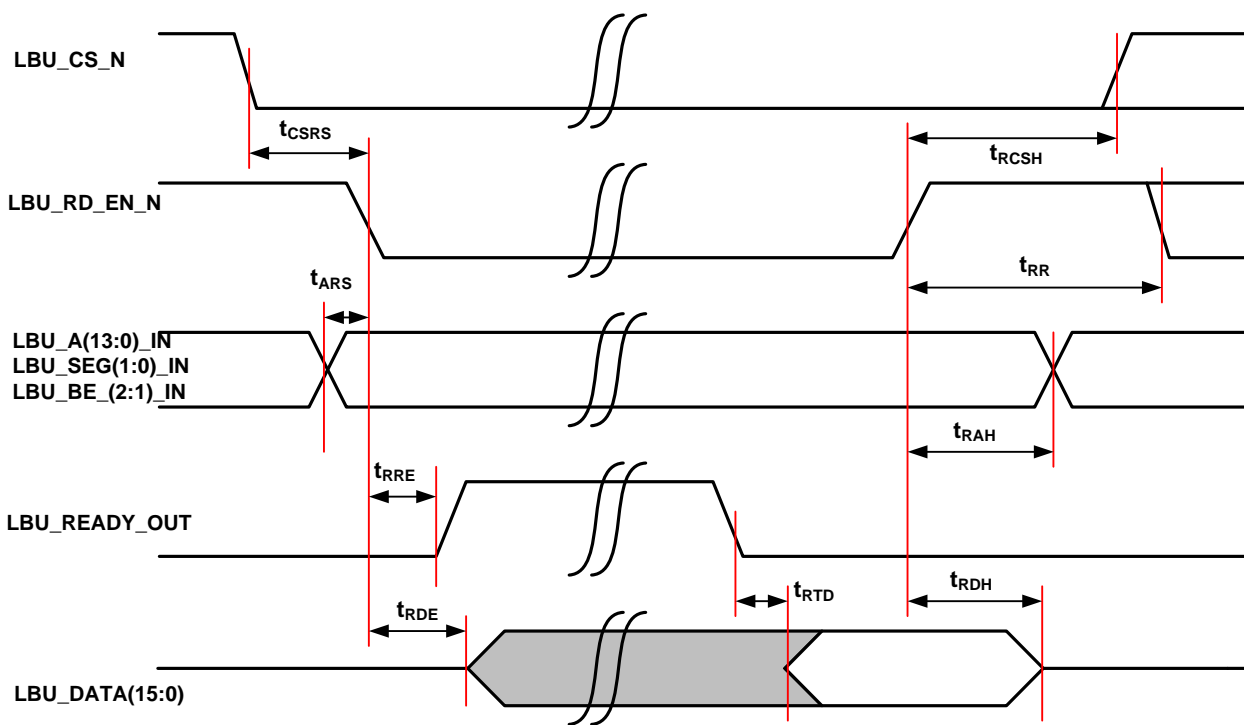

Figure 2-4: Host read with separate read/write line

2.4.2.2.2. Host write to TPS-1 with separate read/write line

(LBU_READY_OUT active low)

$T_A = -40$ to $+85^{\circ}\text{C}$; $V_{DD15} = 1.35\text{ V} \sim 1.65\text{ V}$; $V_{DD33} = 3.0\text{ V} \sim 3.6\text{ V}$

Table 2-10: Host write with separate read/write line

Parameter	Symbol	Condition	MIN.	MAX.	Unit
Chip select asserted to write pulse asserted delay	t_{CSWS}	-	0	-	ns
Address valid to write pulse asserted setup time	t_{AWS}	-	0	-	ns
Write pulse asserted to ready enabled delay	t_{WRE}	-	5	12	ns
Write pulse asserted to data valid delay	t_{WDV}	-	-	40	ns
Write pulse deasserted to chip select deasserted delay	t_{WCSH}	-	0	-	ns
Address hold time after write strobe deasserted	t_{WAH}	-	0	-	ns
Ready asserted to write pulse deasserted delay	t_{RTW}	-	0	-	ns
Data hold time after write pulse deasserted	t_{WDH}	-	0	-	ns
Write recovery time	t_{WR}	-	25	-	ns

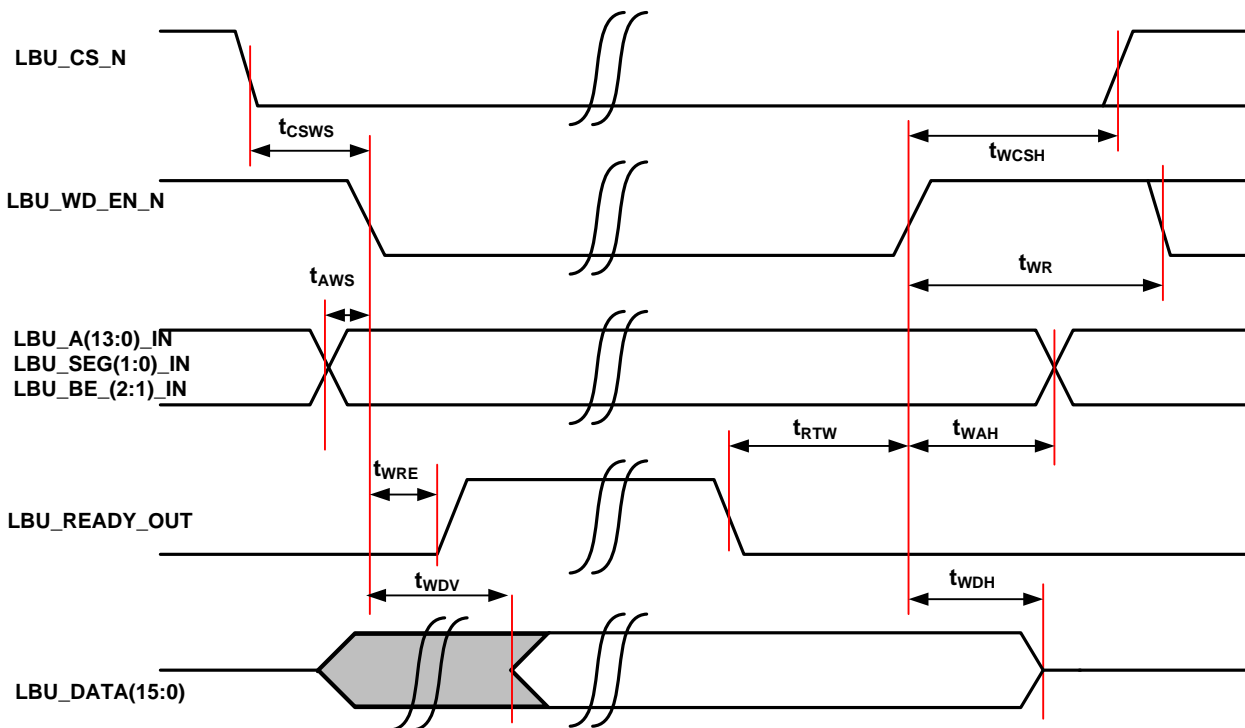

Figure 2-5: Host write with separate read/write line

2.4.2.2.3. Host read from TPS-1 with common read/write line

(LBU_READY_OUT active low)

$T_A = -40$ to $+85^{\circ}\text{C}$; $V_{DD15} = 1.35\text{ V} \sim 1.65\text{ V}$; $V_{DD33} = 3.0\text{ V} \sim 3.6\text{ V}$

Table 2-11: Host read with common read/write line

Parameter	Symbol	Condition	MIN.	MAX.	Unit
Write signal deasserted to chip select asserted setup time	t_{wCS}	-	2	-	ns
Address valid to chip select asserted setup time	t_{ACS}	-	0	-	ns
Chip select asserted to ready enabled delay	t_{CRE}	-	5	12	ns
Chip select asserted to data enable delay	t_{CDE}	-	5	12	ns
Ready asserted to data valid delay	t_{RTD}	-	-	5	ns
Write signal inactive to chip select deasserted hold time	t_{CWH}	-	0	-	ns
Chip select deasserted to address invalid hold time	t_{CAH}	-	0	-	ns
Chip select deasserted to data invalid hold time	t_{CDH}	-	0	12	ns
Read recovery time	t_{RR}	-	25	-	ns

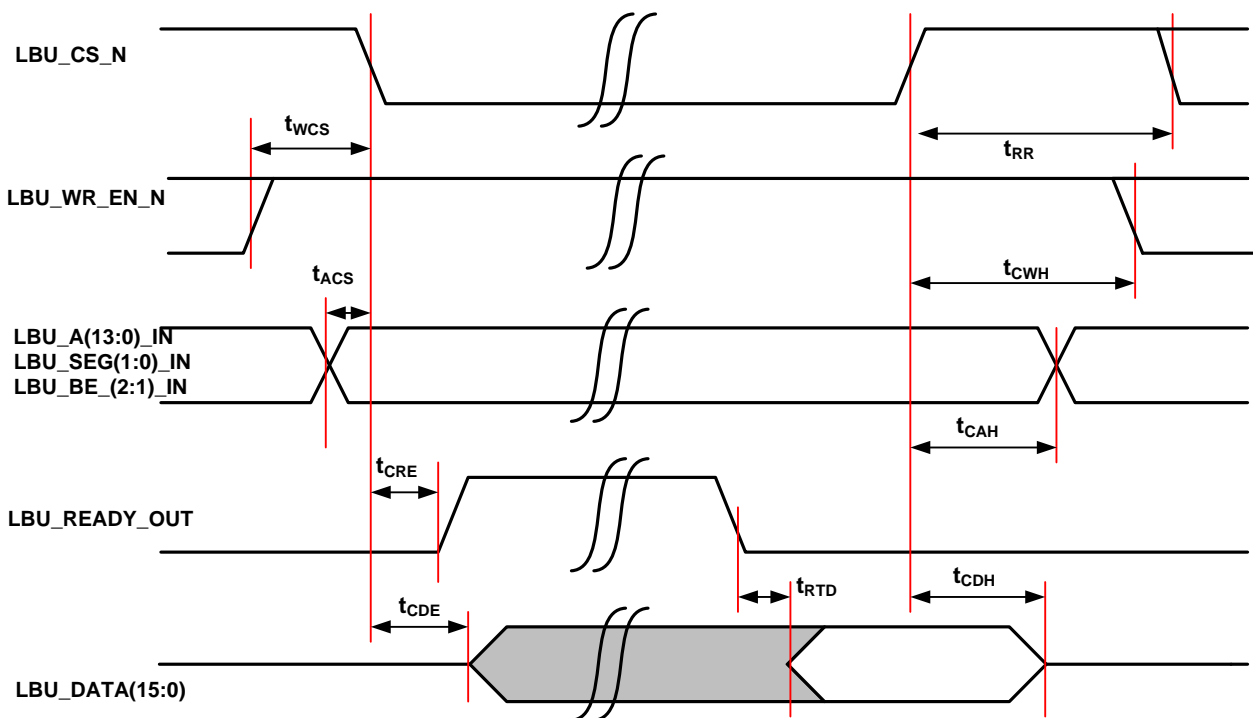

Figure 2-6: Host read with common read/write line

2.4.2.2.4. Host write to TPS-1 with common read/write line

(LBU_READY_OUT active low)

$T_A = -40$ to $+85^{\circ}\text{C}$; $V_{DD15} = 1.35\text{ V} \sim 1.65\text{ V}$; $V_{DD33} = 3.0\text{ V} \sim 3.6\text{ V}$

Table 2-12: Host write with common read/write line

Parameter	Symbol	Condition	MIN.	MAX.	Unit
Write signal deasserted to chip select asserted setup time	t_{wCS}	-	2	-	ns
Address valid to chip select asserted setup time	t_{ACS}	-	0	-	ns
Chip select asserted to ready enabled delay	t_{CRE}	-	5	12	ns
Chip select asserted to data valid delay	t_{CDV}	-	-	40	ns
Write signal deasserted to chip select deasserted hold time	t_{CWH}	-	0	-	ns
Address hold time after chip select deasserted	t_{CAH}	-	0	-	ns
Ready asserted to chip select deasserted delay	t_{RTC}	-	0	-	ns
Chip select deasserted to data invalid hold time	t_{CDH}	-	0	-	ns
Read recovery time	t_{WR}	-	25	-	ns

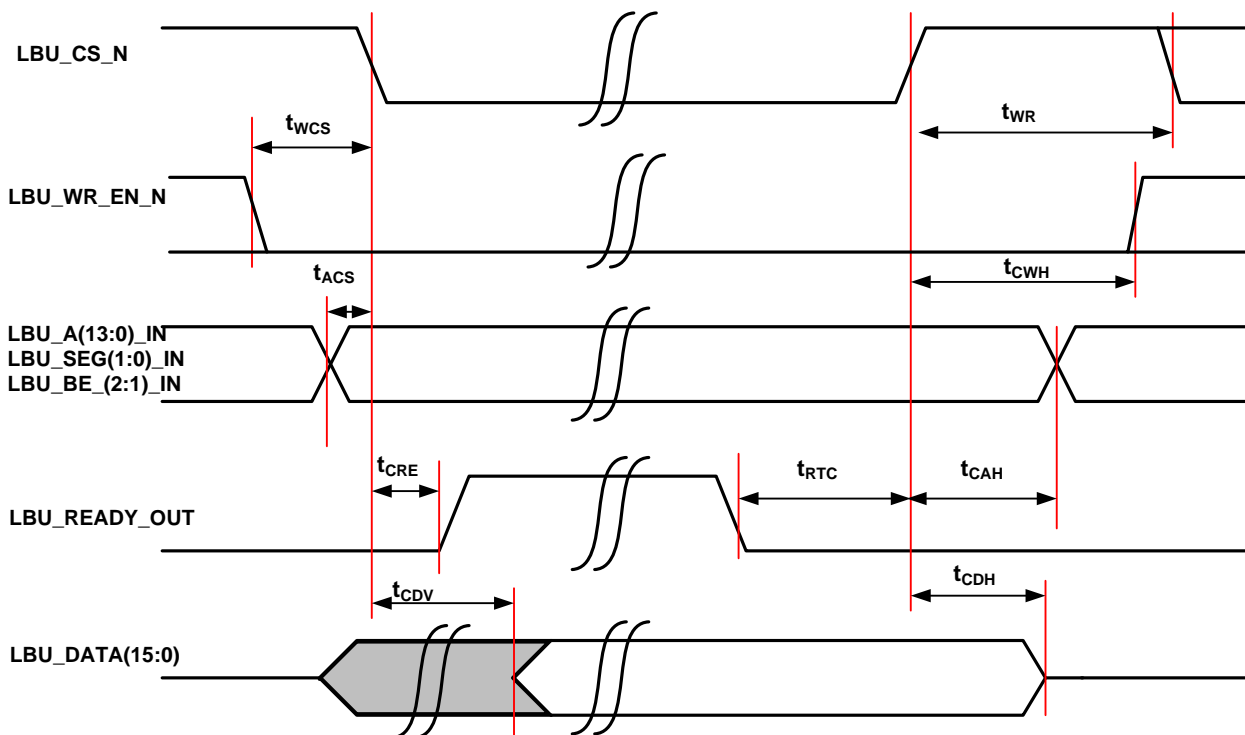

Figure 2-7: Host write with common read/write line

2.4.2.3 SPI Slave Timing

$T_A = -40$ to $+85^{\circ}\text{C}$; $V_{DD15} = 1.35\text{ V} \sim 1.65\text{ V}$; $V_{DD33} = 3.0\text{ V} \sim 3.6\text{ V}$

Table 2-13: SPI Slave Timing

Parameter	Symbol	Condition	Min.	Max.	Unit
SPI clock	t_{cl}	-	40	-	ns
Setup time	t_{su}	-	13	-	ns
Hold time	t_h	-	13	-	ns

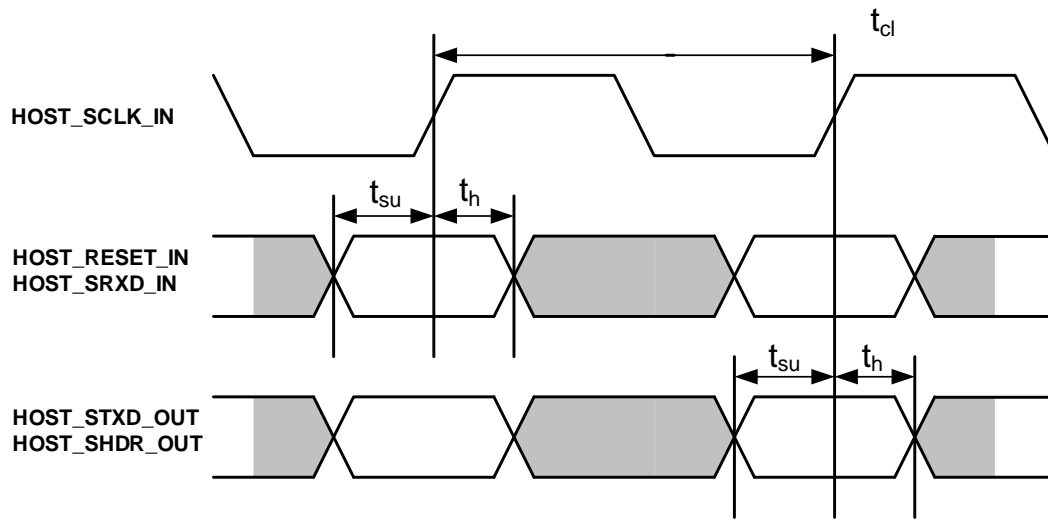

Figure 2-8: SPI Slave Timing

2.4.3. I2C-Bus timing definition

$T_A = -40$ to $+85^\circ\text{C}$; $V_{DD15} = 1.35\text{ V} \sim 1.65\text{ V}$; $V_{DD33} = 3.0\text{ V} \sim 3.6\text{ V}$

Table 2-14: Characteristics of the SCL and SDA lines

Parameter	Symbol	Standard-Mode		Fast-Mode		Unit
		Min.	Max.	Min.	Max.	
SCL clock frequency	f_{SCL}	0	100	0	400	kHz
Bus free time between a STOP and START condition	t_{BUF}	4.7	-	1.3	-	μs
Hold time (repeated) Start condition. After this period, the first clock pulse is generated	$t_{\text{HD;STA}}$	4.0	-	0.6	-	μs
LOW period of the SCL clock	t_{LOW}	4.7	-	1.3	-	μs
HIGH period of the SCL clock	t_{HIGH}	4.0	-	0.6	-	μs
Set-up time for repeated START condition	$t_{\text{SU;DAT}}$	4.7	-	0.6	-	μs
Data hold time	$t_{\text{HD;DAT}}$	0 ⁽¹⁾	-	0 ⁽¹⁾	0.9	μs
Data set-up time	$t_{\text{SU;STA}}$	250	-	100 ⁽²⁾	-	ns
Rise time of both SDA and SCL signals	t_{R}	-	1000	$20+0.1C_b$	300	ns
Fall time of both SDA and SCL signals	t_{F}	-	300	$20+0.1C_b$	300	ns
Capacitive load for each bus line	C_b	-	400	-	400	pF

Notes: 1. The device must internally provide a hold time of at least 300 ns for the SDA signal in order to bridge the undefined region of the falling edge of SCL.
 2. A fast-mode device can be used in a Standard-bus system, but the requirement $t_{\text{SU;STA}}$ must be met.

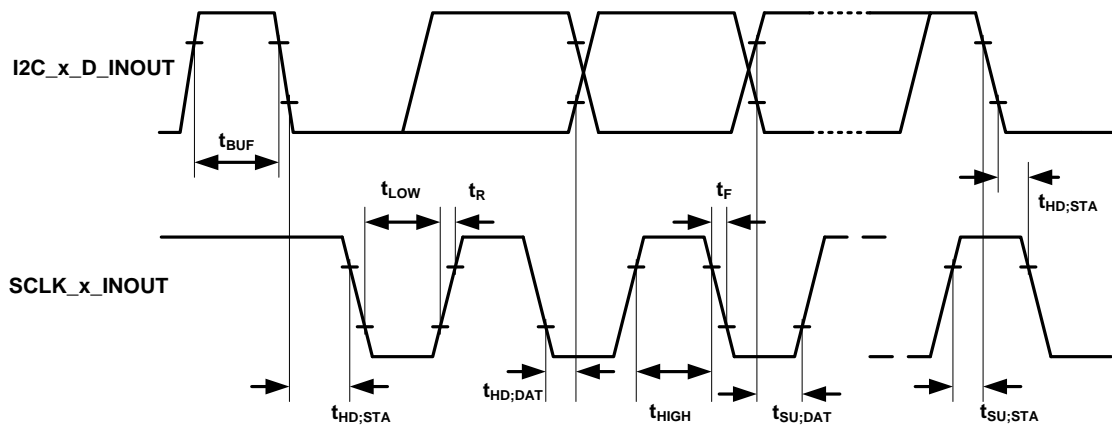

Figure 2-9: I2C-Bus timing definition

2.4.3.1. PHY DC Specifications (100 BASE-TX)

T_A = -40 to +85 °C, AVDD33 = 3.0 to 3.6V, AVDD15 = 1.35 to 1.65V, DVDD = 1.35 to 1.65V

Table 2-15: PHY DC Specification

Parameter	Symbol	Min.	Typ.	Max.	Unit
TX Output, High Level Differential Signal, TXP/TXN	V _{OUTTH}	0.95		1.05	V
TX Output, Low Level Differential Signal, TXP/TXN	V _{OUTL}	-0.95		-1.05	V
TX Output, Mid. Level Differential Signal, TXP/TXN	V _{OUTM}	-0.05		+0.05	V
TX Output, Overshoot Differential Signal, TXP/TXN	V _{OVS}	0		5	%

These specifications are complying with ANSI/IEEE 802.3 Std.

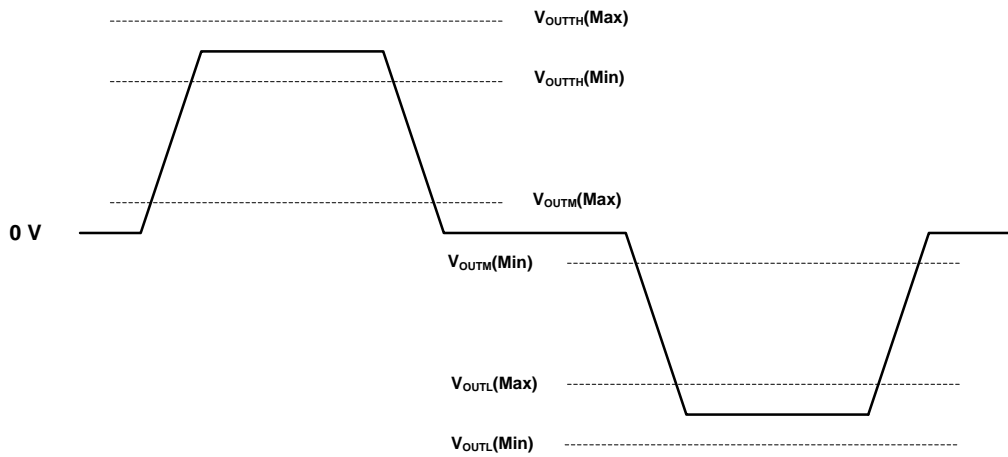

Figure 2-10: PHY DC Specification

2.4.3.2. PHY AC Specifications (100BASE-TX)

T_A = -40 to +85 °C, AVDD33 = 3.0 to 3.6V, AVDD15 = 1.35 to 1.65V, DVDD = 1.35 to 1.65V

Table 2-16: PHY AC Timing

Parameter	Symbol	Min.	Typ.	Max.	Unit
Rise time and fall time, TXP/TXN	t _r , t _f	3		5	ns
Duty cycle distortion, TXP/TXN				0.5	ns
Transmit Jitter, TXP/TXN				1.4	ns

These specifications are complying with ANSI/IEEE 802.3 Std.

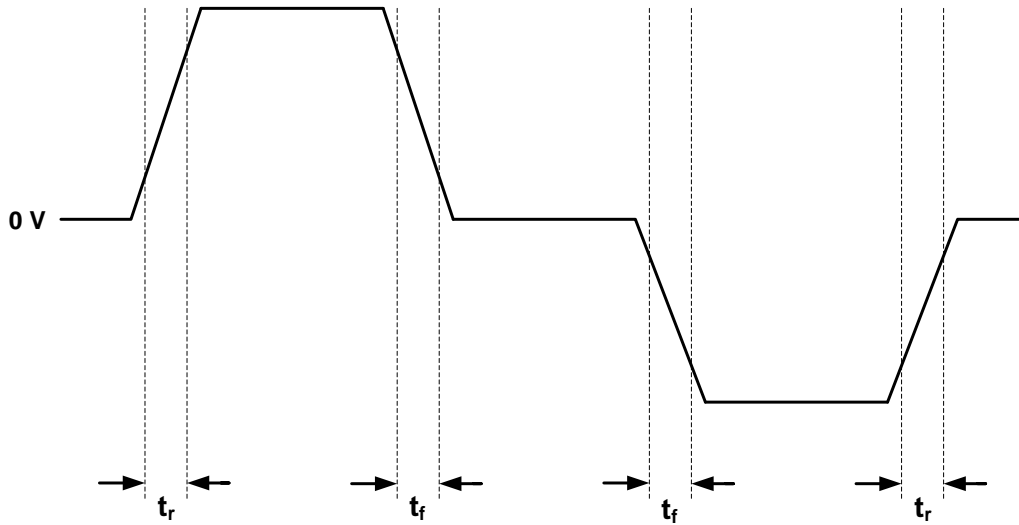

Figure 2-11: PHY AC Specification

2.4.4. Power-up sequence

For operation the TPS-1 needs three supply voltages. These are 3.3V, 1.5V and 1.0V, whereby the 1.5V power supply can be generated internally by a switch regulator. It is also possible to feed this power supply from an external circuitry.

Table 2-17: Signals for Power-Up

Signal TPS-1	Description	Remark
VDD	Power Supply (all voltages)	
RESET_N	External Reset	active low
XCLK_1	Quartz connection (input)	

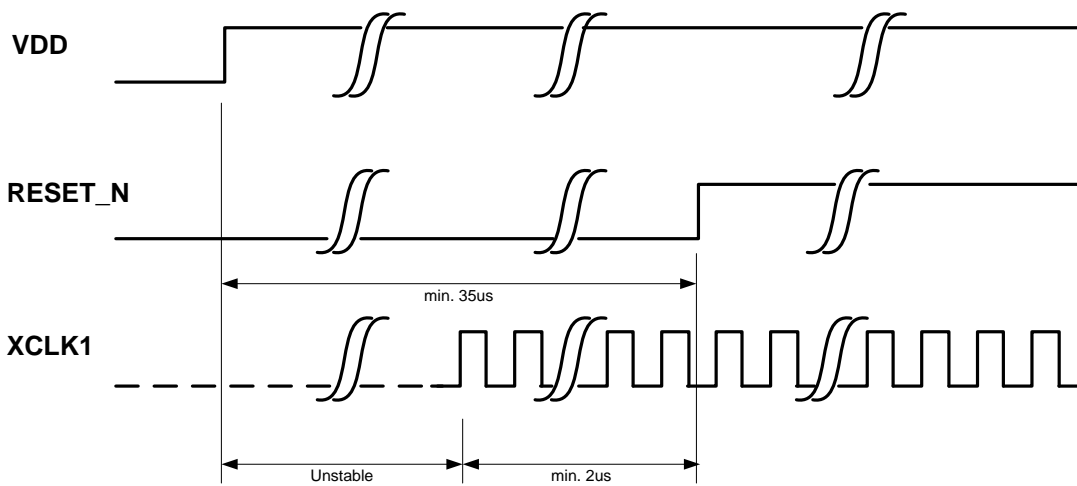

Figure 2-12: Power-Up Sequence Timing Diagram

2.4.5. Reset timing

Table 2-18: Signals for Reset Timing

Signal TPS-1	Description	Remark
XCLK1	Quartz connection (input)	External Signal
CLK_ARM	Clock for the ARM CPU	Internal Signal
RESET_N	External Reset	External Signal (active low)
POR_OUT	Power On Reset	Internal Signal (supply voltages stable)
PLL_LOCK	Clocks are synchronous to XCLK1	Internal Signal

The start-up time of the oscillator cannot be defined by the semiconductor vendor, because the timing heavily depends on the external components (external resonator crystal). Check the TPS-1 User's Manual: Hardware (R19UH0081ED) for details.

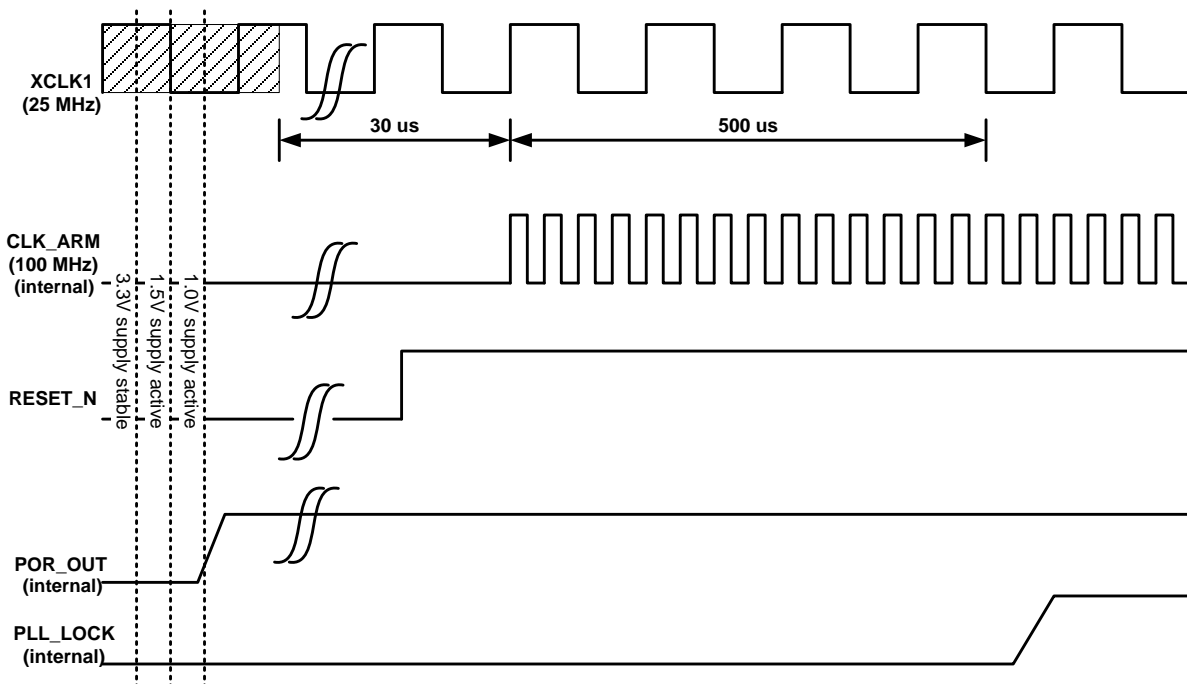

Figure 2-13: Reset Timing Diagram

3. Package Drawing

196-PIN PLASTIC BGA(15x15)

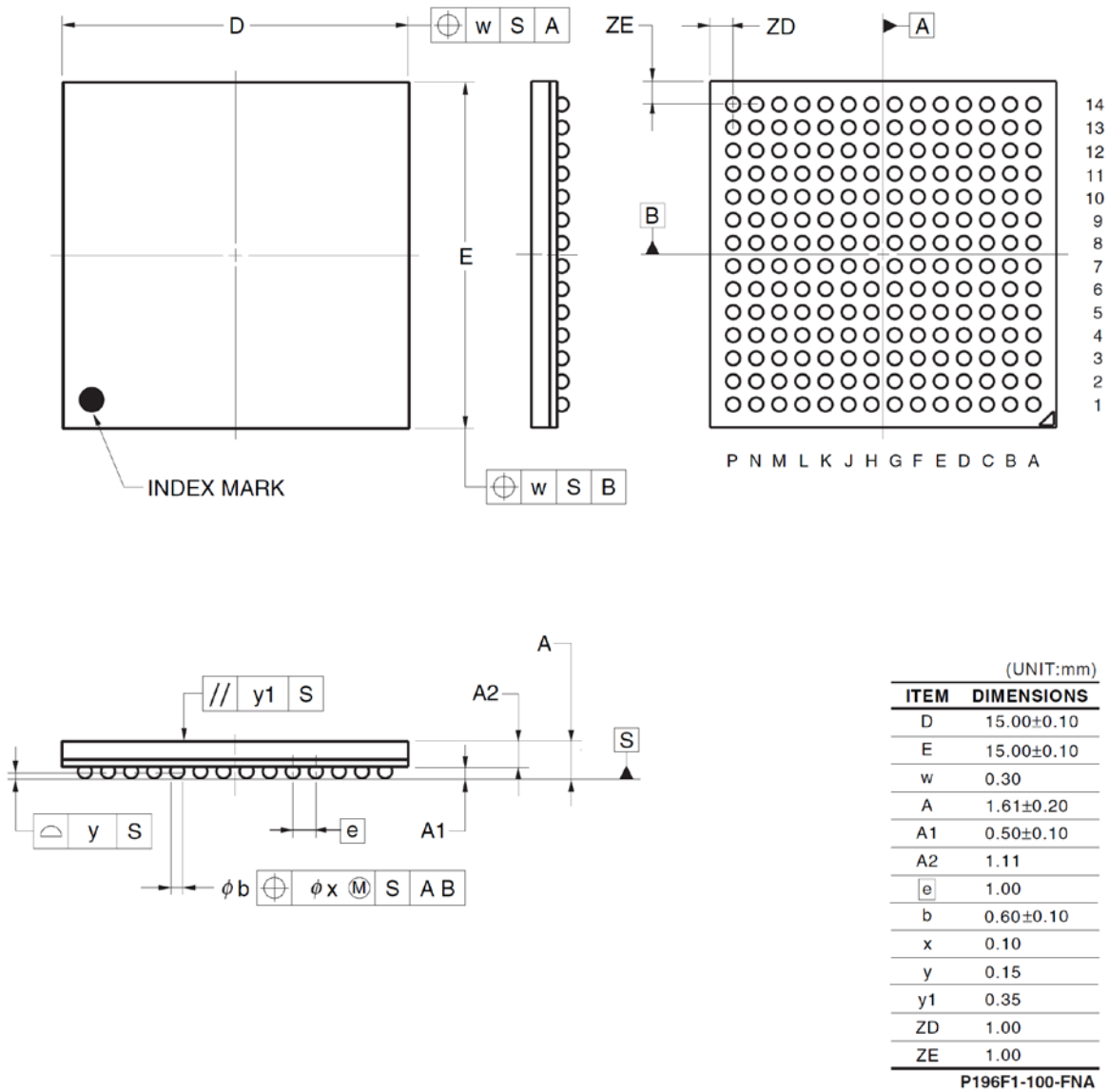

Figure 3-1: 196-ball FPBGA Package Drawing

Package:

Package FPBGA 196 Pins
 Ball Pitch 1.0 mm Pitch
 Dimensions 15 mm * 15 mm

4. Recommended Soldering Conditions

Solder this product under the following recommended conditions.

For details of the recommended soldering conditions, refer to the information document.

Renesas Semiconductor Package Mount Manual, (Rev.5.0, Feb 2015)

(R50ZZ0003EJ0500)

The applied standard is "IR60-107-3".

Table 4-1: Recommended soldering conditions

Condition Symbol	Soldering Conditions
IR60	Package peak temperature: 260°C, Time: 60 seconds max. (at 220°C or higher).
-107	Exposure limit: 7 days ^{Note} (after that, prebake at 125°C for 20 to 72 hours).
-3	Count: Three times or less.

Note: After opening the dry pack, store it at 25°C or less and 65% RH or less for the allowable storage period.

Instructions for the use of product

In this section, the precautions are described for over whole of CMOS device.

Please refer to this manual about individual precaution.

When there is a mention unlike the text of this manual, a mention of the text takes first priority

1. Handling of Unused Pins

Handle unused pins in accord with the directions given under Handling of Unused Pins in the manual.

- The input pins of CMOS products are generally in the high-impedance state. In operation with an unused pin in the open-circuit state, extra electromagnetic noise is induced in the vicinity of LSI, associated shoot-through current flows internally, and malfunctions occur due to the false recognition of the pin state as an input signal become possible. Unused pins should be handled as described under Handling of Unused Pins in the manual.

2. Processing at Power-on

The state of the product is undefined at the moment when power is supplied.

- The states of internal circuits in the LSI are indeterminate and the states of register settings and pins are undefined at the moment when power is supplied.

In a finished product where the reset signal is applied to the external reset pin, the states of pins are not guaranteed from the moment when power is supplied until the reset process is completed.

In a similar way, the states of pins in a product that is reset by an on-chip power-on reset function are not guaranteed from the moment when power is supplied until the power reaches the level at which resetting has been specified.

3. Prohibition of Access to Reserved Addresses

Access to reserved addresses is prohibited.

- The reserved addresses are provided for the possible future expansion of functions. Do not access these addresses; the correct operation of LSI is not guaranteed if they are accessed.

4. Clock Signals

After applying a reset, only release the reset line after the operating clock signal has become stable. When switching the clock signal during program execution, wait until the target clock signal has stabilized.

- When the clock signal is generated with an external resonator (or from an external oscillator) during a reset, ensure that the reset line is only released after full stabilization of the clock signal. Moreover, when switching to a clock signal produced with an external resonator (or by an external oscillator) while program execution is in progress, wait until the target clock signal is stable.

Notice

1. Descriptions of circuits, software and other related information in this document are provided only to illustrate the operation of semiconductor products and application examples. You are fully responsible for the incorporation of these circuits, software, and information in the design of your equipment. Renesas Electronics assumes no responsibility for any losses incurred by you or third parties arising from the use of these circuits, software, or information.
2. Renesas Electronics has used reasonable care in preparing the information included in this document, but Renesas Electronics does not warrant that such information is error free. Renesas Electronics assumes no liability whatsoever for any damages incurred by you resulting from errors in or omissions from the information included herein.
3. Renesas Electronics does not assume any liability for infringement of patents, copyrights, or other intellectual property rights of third parties by or arising from the use of Renesas Electronics products or technical information described in this document. No license, express, implied or otherwise, is granted hereby under any patents, copyrights or other intellectual property rights of Renesas Electronics or others.
4. You should not alter, modify, copy, or otherwise misappropriate any Renesas Electronics product, whether in whole or in part. Renesas Electronics assumes no responsibility for any losses incurred by you or third parties arising from such alteration, modification, copy or otherwise misappropriation of Renesas Electronics product.
5. Renesas Electronics products are classified according to the following two quality grades: "Standard" and "High Quality". The recommended applications for each Renesas Electronics product depends on the product's quality grade, as indicated below.

"Standard": Computers; office equipment; communications equipment; test and measurement equipment; audio and visual equipment; home electronic appliances; machine tools; personal electronic equipment; and industrial robots etc.

"High Quality": Transportation equipment (automobiles, trains, ships, etc.); traffic control systems; anti-disaster systems; anti-crime systems; and safety equipment etc.

Renesas Electronics products are neither intended nor authorized for use in products or systems that may pose a direct threat to human life or bodily

injury (artificial life support devices or systems, surgical implantations etc.), or may cause serious property damages (nuclear reactor control systems, military equipment etc.). You must check the quality grade of each Renesas Electronics product before using it in a particular application. You may not use any Renesas Electronics product for any application for which it is not intended. Renesas Electronics shall not be in any way liable for any damages or losses incurred by you or third parties arising from the use of any Renesas Electronics product for which the product is not intended by Renesas Electronics.

6. You should use the Renesas Electronics products described in this document within the range specified by Renesas Electronics, especially with respect to the maximum rating, operating supply voltage range, movement power voltage range, heat radiation characteristics, installation and other product characteristics. Renesas Electronics shall have no liability for malfunctions or damages arising out of the use of Renesas Electronics products beyond such specified ranges.
7. Although Renesas Electronics endeavors to improve the quality and reliability of its products, semiconductor products have specific characteristics such as the occurrence of failure at a certain rate and malfunctions under certain use conditions. Further, Renesas Electronics products are not subject to radiation resistance design. Please be sure to implement safety measures to guard them against the possibility of physical injury, and injury or damage caused by fire in the event of the failure of a Renesas Electronics product, such as safety design for hardware and software including but not limited to redundancy, fire control and malfunction prevention, appropriate treatment for aging degradation or any other appropriate measures. Because the evaluation of microcomputer software alone is very difficult, please evaluate the safety of the final products or systems manufactured by you.
8. Please contact a Renesas Electronics sales office for details as to environmental matters such as the environmental compatibility of each Renesas Electronics product. Please use Renesas Electronics products in compliance with all applicable laws and regulations that regulate the inclusion or use of controlled substances, including without limitation, the EU RoHS Directive. Renesas Electronics assumes no liability for damages or losses occurring as a result of your noncompliance with applicable laws and regulations.
9. Renesas Electronics products and technology may not be used for or incorporated into any products or systems whose manufacture, use, or sale is prohibited under any applicable domestic or foreign laws or regulations. You should not use Renesas Electronics products or technology described in this document for any purpose relating to military applications or use by the military, including but not limited to the development of weapons of mass destruction. When exporting the Renesas Electronics products or technology described in this document, you



SALES OFFICES

Renesas Electronics Corporation

<http://www.renesas.com>

Renesas Electronics America Inc.

2880 Scott Boulevard Santa Clara, CA 95050-2554, U.S.A.
Tel: +1-408-588-6000, Fax: +1-408-588-6130

Renesas Electronics Canada Limited

1101 Nicholson Road, Newmarket, Ontario L3Y 9C3, Canada
Tel: +1-905-898-5441, Fax: +1-905-898-3220

Renesas Electronics Europe Limited

Dukes Meadow, Millboard Road, Bourne End, Buckinghamshire, SL8 5FH, U.K.
Tel: +44-1628-651-700, Fax: +44-1628-651-804

Renesas Electronics Europe GmbH

Arcadiastrasse 10, 40472 Düsseldorf, Germany
Tel: +49-211-65030, Fax: +49-211-6503-1327

Renesas Electronics (China) Co., Ltd.

7th Floor, Quantum Plaza, No.27 ZhiChunLu Haidian District, Beijing 100083, P.R.China
Tel: +86-10-8235-1155, Fax: +86-10-8235-7679

Renesas Electronics (Shanghai) Co., Ltd.

Unit 204, 205, AZIA Center, No.1233 Lujiazui Ring Rd., Pudong District, Shanghai 200120, China
Tel: +86-21-5877-1818, Fax: +86-21-6887-7858 / -7898

Renesas Electronics Hong Kong Limited

Unit 1601-1613, 16/F., Tower 2, Grand Century Place, 193 Prince Edward Road West, Mongkok, Kowloon, Hong Kong
Tel: +852-2886-9318, Fax: +852 2886-9022/9044

Renesas Electronics Taiwan Co., Ltd.

13F, No. 363, Fu Shing North Road, Taipei, Taiwan
Tel: +886-2-8175-9600, Fax: +886 2-8175-9670

Renesas Electronics Singapore Pte. Ltd.

80 Bendemeer Road, Unit #06-02 Hyflux Innovation Centre Singapore 339949
Tel: +65-6213-0200, Fax: +65-6213-0300

Renesas Electronics Malaysia Sdn.Bhd.

Unit 906, Block B, Menara Amcorp, Amcorp Trade Centre, No. 18, Jln Persiaran Barat, 46050 Petaling Jaya, Selangor Darul Ehsan, Malaysia
Tel: +60-3-7955-9390, Fax: +60-3-7955-9510

Renesas Electronics Korea Co., Ltd.

11F., Samik Lavied' or Bldg., 720-2 Yeoksam-Dong, Kangnam-Ku, Seoul 135-080, Korea
Tel: +82-2-558-3737, Fax: +82-2-558-5141

© 2012-2015 Renesas Electronics Corporation. All rights reserved