

Mini-ISO Automotive Relay

CB RELAYS

<Protective construction>
Flux tight/Sealed



(Unit: mm inch)

RoHS compliant

FEATURES

- This relay has an Mini-ISO (International Organization for Standardization) terminal arrangement.
- Compact and high capacity
- Features heat resistant type
- Built-in resistor type is also available.

TYPICAL APPLICATIONS

- **Automobiles**
Cell motors, Air conditioners, ABS, EPS, etc.
- **Construction equipment**
- **Agricultural equipment, Conveyor, etc.**

ORDERING INFORMATION



TYPES

Contact arrangement	Mounting classification	Rated coil voltage	Standard type		Heat resistant type		Packing	
			Sealed	Flux tight	Sealed	Flux tight	Carton	Case
			Type No.	Type No.	Type No.	Type No.		
1 Form A	PC board type	12V DC	CB1a-P-12V	CB1aF-P-12V	CB1a-T-P-12V	CB1aF-T-P-12V	50 pcs.	200 pcs.
		24V DC	CB1a-P-24V	CB1aF-P-24V	CB1a-T-P-24V	CB1aF-T-P-24V		
	Plug-in type	12V DC	CB1a-12V	CB1aF-12V	CB1a-T-12V	CB1aF-T-12V		
		24V DC	CB1a-24V	CB1aF-24V	CB1a-T-24V	CB1aF-T-24V		
	Bracket type	12V DC	CB1a-M-12V	CB1aF-M-12V	CB1a-T-M-12V	CB1aF-T-M-12V		
		24V DC	CB1a-M-24V	CB1aF-M-24V	CB1a-T-M-24V	CB1aF-T-M-24V		
1 Form C	PC board type	12V DC	CB1-P-12V	CB1F-P-12V	CB1-T-P-12V	CB1F-T-P-12V		
		24V DC	CB1-P-24V	CB1F-P-24V	CB1-T-P-24V	CB1F-T-P-24V		
	Plug-in type	12V DC	CB1-12V	CB1F-12V	CB1-T-12V	CB1F-T-12V		
		24V DC	CB1-24V	CB1F-24V	CB1-T-24V	CB1F-T-24V		
	Bracket type	12V DC	CB1-M-12V	CB1F-M-12V	CB1-T-M-12V	CB1F-T-M-12V		
		24V DC	CB1-M-24V	CB1F-M-24V	CB1-T-M-24V	CB1F-T-M-24V		
1 Form A High contact capacity	PC board type	12V DC	CB1aH-P-12V	CB1aHF-P-12V	CB1aH-T-P-12V	CB1aHF-T-P-12V		
		24V DC	CB1aH-P-24V	CB1aHF-P-24V	CB1aH-T-P-24V	CB1aHF-T-P-24V		
	Plug-in type	12V DC	CB1aH-12V	CB1aHF-12V	CB1aH-T-12V	CB1aHF-T-12V		
		24V DC	CB1aH-24V	CB1aHF-24V	CB1aH-T-24V	CB1aHF-T-24V		
	Bracket type	12V DC	CB1aH-M-12V	CB1aHF-M-12V	CB1aH-T-M-12V	CB1aHF-T-M-12V		
		24V DC	CB1aH-M-24V	CB1aHF-M-24V	CB1aH-T-M-24V	CB1aHF-T-M-24V		

Note: Please use "CB***R**" to order with resistor inside type. (Asterisks "*" should be filled in from ORDERING INFORMATION.)

RATING

1. Coil data

1) No protective element

Contact arrangement	Rated coil voltage	Operate (Set) voltage (at 20°C 68°F) (Initial)	Release (Reset) voltage (at 20°C 68°F) (Initial)	Rated operating current [±10%] (at 20°C 68°F)	Coil resistance [±10%] (at 20°C 68°F)	Rated operating power (at 20°C 68°F)	Usable voltage range
1 Form A, 1 Form C	12V DC	3 to 7V DC	1.2 to 4.2V DC	117mA	103Ω	1.4W	10 to 16V DC
	24V DC	6 to 14V DC	2.4 to 8.4V DC	75mA	320Ω	1.8W	20 to 32V DC
1 Form A High contact capacity	12V DC	3 to 7V DC	1.2 to 4.2V DC	117mA	103Ω	1.4W (PC board type)	10 to 16V DC
				150mA	80Ω	1.8W	
	24V DC	6 to 14V DC	2.4 to 8.4V DC	58mA	411Ω	1.4W (PC board type)	20 to 32V DC
				75mA	320Ω	1.8W	

Note: Other operate (set) voltage types are also available. Please inquire our sales representative for details.

2) With resistor inside

Contact arrangement	Rated coil voltage	Operate (Set) voltage (at 20°C 68°F) (Initial)	Release (Reset) voltage (at 20°C 68°F) (Initial)	Rated operating current [±10%] (at 20°C 68°F)	Equivalent coil resistance [±10%] (at 20°C 68°F)	Rated operating power (at 20°C 68°F)	Usable voltage range
1 Form A, 1 Form C	12V DC	3 to 7V DC	1.2 to 4.2V DC	134mA	89.5Ω	1.6W	10 to 16V DC
	24V DC	6 to 14V DC	2.4 to 8.4V DC	84mA	287.2Ω	2.0W	20 to 32V DC
1 Form A High contact capacity	12V DC	3 to 7V DC	1.2 to 4.2V DC	134mA	89.5Ω	1.6W (PC board type)	10 to 16V DC
				168mA	71.6Ω	2.0W	
	24V DC	6 to 14V DC	2.4 to 8.4V DC	67mA	358Ω	1.6W (PC board type)	20 to 32V DC
				84mA	287.2Ω	2.0W	

2. Specifications

1) Standard type (12 V coil voltage)

Item		Specification		
Contact data	Contact arrangement	1 Form A	1 Form C	1 Form A High contact capacity
	Contact resistance (initial)	Max. 15mΩ (Typ. 2mΩ) (By voltage drop 1A 6V DC)		
	Contact material	Ag alloy		
	Rated switching capacity (resistive)	40A 14V DC	N.O. side: 40A 14V DC N.C. side: 30A 14V DC	70A 14V DC (at 20°C 68°F) 50A 14V DC (at 85°C 185°F)
	Max. carrying current (initial) (coil applied voltage 14V DC, at 85°C 185°F, continuous)	N.O. side: 40A	N.O. side: 40A N.C. side: 30A	N.O. side: 40A
Min. switching load (resistive)*1	1A 14V DC (at 20°C 68°F)			
Insulated resistance (initial)		Min. 20 MΩ (at 500V DC, Measurement at same location as "Dielectric strength" section.)		
Dielectric strength (initial)	Between open contacts	500 Vrms for 1 min. (Detection current: 10mA)		
	Between contacts and coil	500 Vrms for 1 min. (Detection current: 10mA)		
Time characteristics (initial)	Operate (Set) time (at rated coil voltage)	Max. 15ms (at 20°C 68°F, without contact bounce time)		
	Release (Reset) time (at rated coil voltage)	Max. 15ms (at 20°C 68°F, without contact bounce time) (Without diode)		
Shock resistance	Functional	Min. 200 m/s ² {approx. 20G} (Half-wave pulse of sine wave: 11ms; detection time: 10μs)		
	Destructive	Min. 1,000 m/s ² {approx. 100G} (Half-wave pulse of sine wave: 6ms)		
Vibration resistance	Functional	10 to 500 Hz, Min. 44.1m/s ² {approx. 4.5G} (Detection time: 10μs)		
	Destructive	10 to 2,000 Hz, Min. 44.1m/s ² {approx. 4.5G} Time of vibration for each direction; X, Y, Z direction: 4 hours		
Expected life	Mechanical	Min. 10 ⁶ (at 120 cpm)		
	Electrical (at rated switching capacity)	Flux tight: Min. 10 ⁵ , Sealed: Min. 5×10 ⁴ (Operating frequency: 2s ON, 2s OFF)		
Conditions	Conditions for usage, transport and storage*2	Standard; Ambient temperature: -40 to +85°C -40 to +185°F, Humidity: 5 to 85% R.H. (Please avoid icing or condensation)		
		Heat resistant; Ambient temperature: -40 to +125°C -40 to +257°F, Humidity: 5 to 85% R.H. (Please avoid icing or condensation)		
Weight		Approx. 33 g 1.16 oz		

Notes: *1. Depends on connection conditions. Also, this does not guarantee repeated switching. We recommend that you confirm operation under actual conditions.

*2. The upper operation ambient temperature limit is the maximum temperature that can satisfy the coil temperature rise value. For details, please refer to the "Automotive Relay Users Guide".

Please inquire our sales representative if you will be using the relay in a high temperature atmosphere (110°C 230°F)

2) Standard type (24 V coil voltage)

Item		Specifications		
Contact data	Contact arrangement	1 Form A	1 Form C	1 Form A High contact capacity
	Contact resistance (initial)	Max. 15mΩ (By voltage drop 1A 6V DC)		
	Contact material	Ag alloy		
	Rated switching capacity (resistive)	20A 28V DC	N.O. side: 20A 28V DC N.C. side: 10A 28V DC	20A 28V DC
Max. carrying current (initial) (28V DC, at 85°C 185°F, continuous)	20A	N.O. side: 20A N.C. side: 10A	20A	

Note: All other specifications are the same as those of standard type (12 V coil voltage)

3) Heat resistant type (12 V and 24 V coil voltage)

Item		Specifications					
		12V			24V		
Contact data	Contact arrangement	1 Form A	1 Form C	1 Form A High contact capacity	1 Form A	1 Form C	1 Form A High contact capacity
	Contact resistance (initial)	Max. 15mΩ (By voltage drop 1A 6V DC)					
	Contact material	Ag alloy					
	Rated switching capacity (resistive)	40A 14V DC	N.O. side: 40A 14V DC N.C. side: 30A 14V DC	40A 14V DC	20A 28V DC	N.O. side: 20A 28V DC N.C. side: 10A 28V DC	20A 28V DC
Max. carrying current (initial) (at 85°C 185°F, continuous)*	50A 14V DC	N.O. side: 50A 14V DC N.C. side: 30A 14V DC	45A 14V DC 50A 14V DC	25A 28V DC	N.O. side: 25A 28V DC N.C. side: 10A 28V DC	25A 28V DC	

Notes: 1. All other specifications are the same as those of standard type (12 V coil voltage)

2. *Current value in which carry current is possible when the coil temperature is 180°C 356°F

REFERENCE DATA

CB RELAYS (Standard)

1. Allowable ambient temperature (Heat resistant and standard)



2. Max. switching capability (Resistive) (Standard)



3. Ambient temperature and usable voltage range (Standard)



Notes:

- Maximum mean coil temperature: 180°C 356°F
- Curves are based on 1.4W (Nominal power consumption of the unsuppressed coil at nominal voltage)

4. Distribution of operate (set) and release (reset) voltage

Sample: CB1-P-12V, 42pcs.



5. Distribution of operate (set) and release (reset) time

Sample: CB1-P-12V, 42pcs.



6. Electrical life test (Motor free)

Sample: CB1F-12V, 5pcs.
Load: 25A 14V DC, motor free actual load
Operating frequency: ON 1s, OFF 9s
Ambient temperature: Room temperature
Circuit:

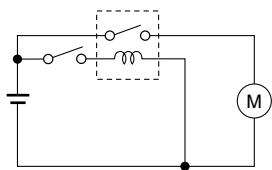

Change of operate (set) and release (reset) voltage

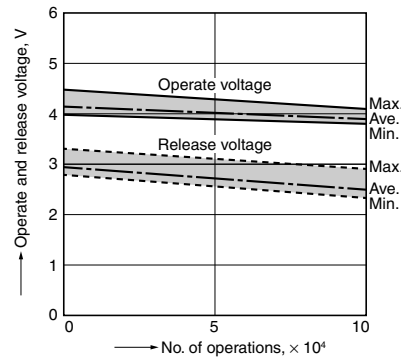

Change of contact resistance

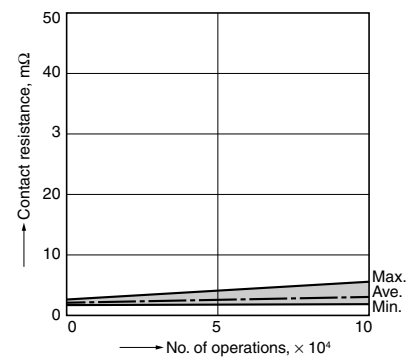

Load current waveform

Load; Inrush current: 80A, Steady current: 25A

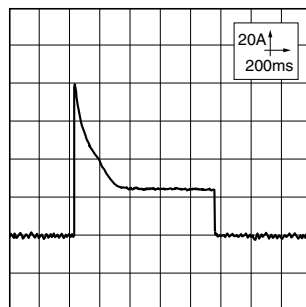

CB RELAYS (High contact capacity)

1. Allowable ambient temperature
(High resistant and high contact capacity)

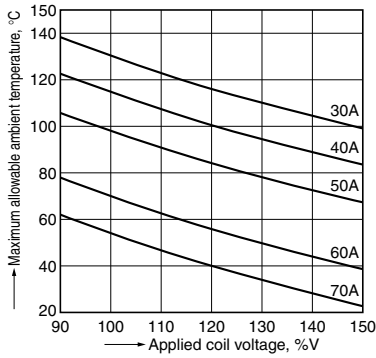

Notes:

- Maximum mean coil temperature: 180°C 356°F
- Curves are based on 1.4W (Nominal power consumption of the unsuppressed coil at nominal voltage)

2. Ambient temperature and usable voltage range
(High contact capacity and standard)

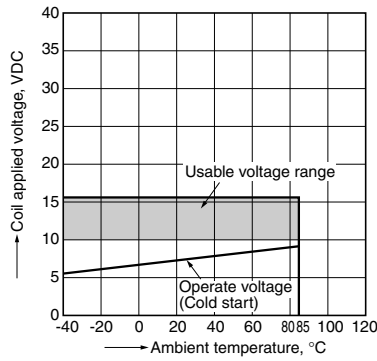

3. Distribution of operate (set) and release (reset) voltage
(Sample: CB1aHF-12V, 53pcs.)

Sample: CB1aHF-12V, 53pcs.

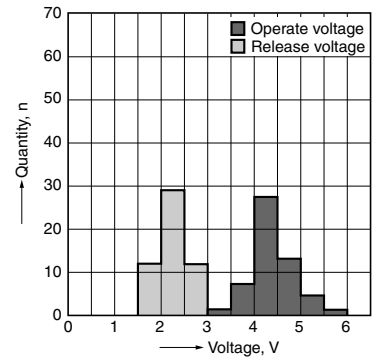

4. Distribution of operate and release time
Sample: CB1aHF-12V, 53pcs.

Sample: CB1aHF-12V, 53pcs.

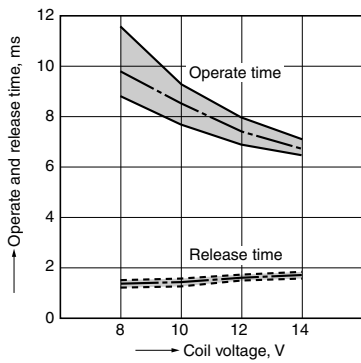

5. Contact resistance
Sample: CB1aHF-12V, 53pcs.

Sample: CB1aHF-12V, 53pcs.
(By voltage drop 1A 6V DC)

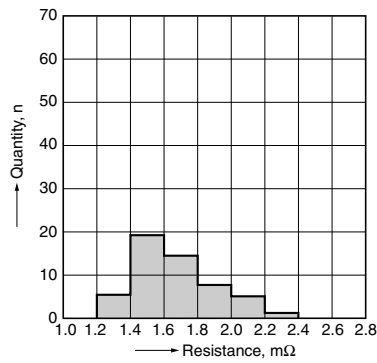

6. Electrical life test (Motor free)

Sample: CB1aH-12V, 3pcs.

Load: Inrush current: 64A, Steady current: 35A

Fan motor actual load (motor free) 12V DC

Operating frequency: ON 3s, OFF 7s

Ambient temperature: Room temperature

Circuit:

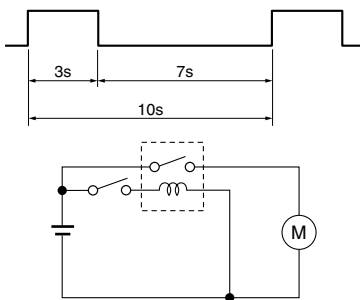

Change of operate (set) and release (reset) voltage

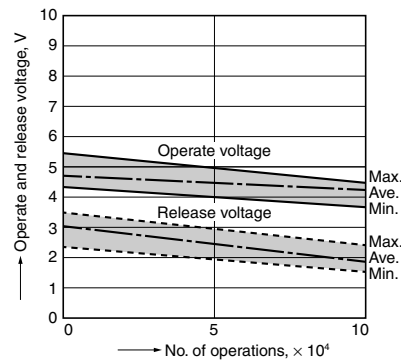

Change of contact resistance

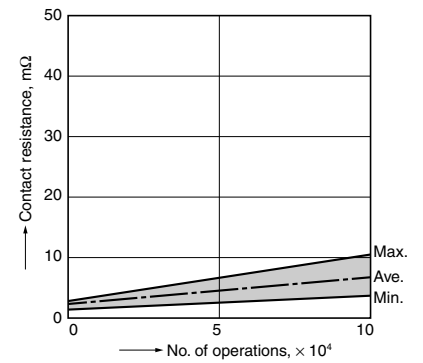

Load current waveform

Load; Inrush current: 64A, Steady current: 35A

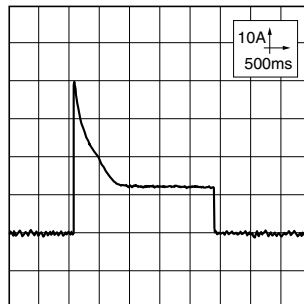

CB (ACB)

DIMENSIONS (mm inch)

The CAD data of the products with a **CAD** mark can be downloaded from: <http://industrial.panasonic.com/ac/e/>

1. PC board type

CAD



External dimensions

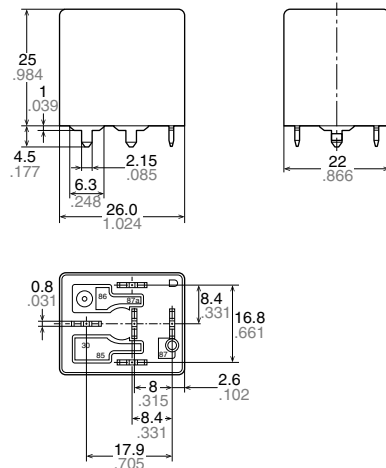

Dimension:	Tolerance
Max. 1mm .039 inch:	±0.1 ±.004
1 to 3mm .039 to .118 inch:	±0.2 ±.008
Min. 3mm .118 inch:	±0.3 ±.012

Schematic (Bottom view)

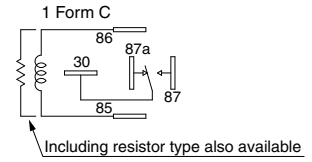
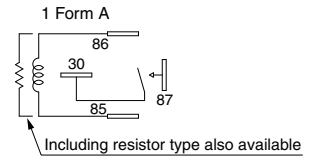

PC board pattern (Bottom view)



Tolerance: ±0.1 ±.004

2. Plug-in type

CAD



External dimensions



Dimension:	Tolerance
Max. 1mm .039 inch:	±0.1 ±.004
1 to 3mm .039 to .118 inch:	±0.2 ±.008
Min. 3mm .118 inch:	±0.3 ±.012

Schematic (Bottom view)

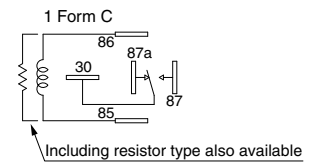
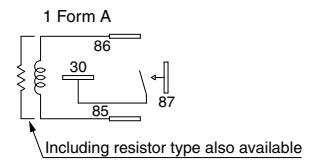

3. Bracket type

CAD



External dimensions

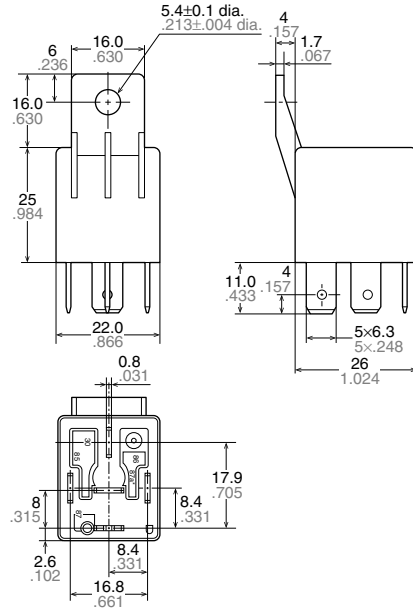

Schematic (Bottom view)



Dimension:	Tolerance
Max. 1mm .039 inch:	±0.1 ±.004
1 to 3mm .039 to .118 inch:	±0.2 ±.008
Min. 3mm .118 inch:	±0.3 ±.012

4. 1 Form A high contact capacity (Plug-in type)

CAD



External dimensions



Schematic (Bottom view)

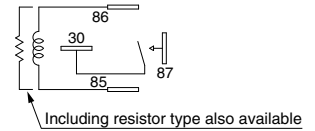

Dimension:	Tolerance
Max. 1mm .039 inch:	±0.1 ±.004
1 to 3mm .039 to .118 inch:	±0.2 ±.008
Min. 3mm .118 inch:	±0.3 ±.012

CB (ACB)

5.1 Form A high contact capacity (PC board type)

CAD



External dimensions



Schematic (Bottom view)

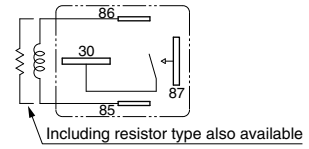

PC board pattern (Bottom view)

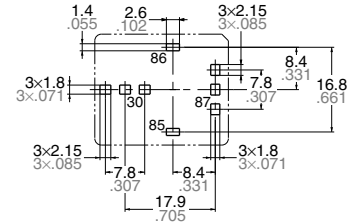

* Intervals between terminals is measured at A surface level.

Tolerance: $\pm 0.1 \pm 0.004$

Dimension:	Tolerance
Max. 1mm .039 inch:	$\pm 0.1 \pm 0.004$
1 to 3mm .039 to .118 inch:	$\pm 0.2 \pm 0.008$
Min. 3mm .118 inch:	$\pm 0.3 \pm 0.12$

NOTES

1. Soldering

Max. 350°C 662°F (solder temperature), within 3 seconds (soldering time)

The effect on the relay depends on the actual PC board used. Please verify the PC board to be used.

2. Usage, transport and storage conditions

1) Ambient temperature, humidity, and air pressure during usage, transport, and storage of the relay:

(1) Temperature: -40 to +85°C -40 to +185°F (Standard type)

-40 to +125°C -40 to +257°F (High heat-resistant type)

(2) Humidity: 2 to 85% RH (Avoid icing and condensation.)

(3) Air pressure: 86 to 106 kPa

The humidity range varies with the temperature. Use within the range indicated in the graph below.

[Temperature and humidity range for usage, transport, and storage]

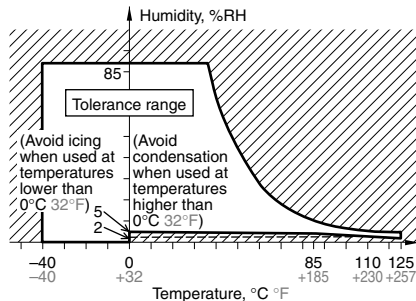

For general cautions for use, please refer to the “Automotive Relay Users Guide”.

Please contact

Panasonic Corporation

Electromechanical Control Business Division

■ 1006, Oaza Kadoma, Kadoma-shi, Osaka 571-8506, Japan
industrial.panasonic.com/ac/e/

Panasonic[®]

©Panasonic Corporation 2017