

OPTIREG™ switcher TLS4120D0EPV

2.8 MHz synchronous step down regulator



Order now



Technical documents



Simulation



Family overview



Support



RoHS

Features

- 2 A step down regulator
- Input voltage from 3.7 V to 35 V
- Adjustable output voltage 3.0 V to 10.0 V
- $\pm 1.5\%$ feedback voltage accuracy in PWM mode
- Ultra low current consumption 31 μA
- Integrated high side and low side power MOSFETs
- Peak current mode PWM regulation
- Light load PFM mode with improved efficiency
- Switching frequency range: 320 kHz to 560 kHz or 1.6 MHz to 2.8 MHz
- 100% duty cycle operation
- Synchronization input
- Spread spectrum frequency modulation for improved EMI performance
- Soft-start function
- Integrated compensation network
- Output discharge function in disabled state
- Ultra low current consumption in disabled state (typically 1 μA)
- Undervoltage monitoring
- Overvoltage monitoring
- Overcurrent protection and overload protection
- Input undervoltage shutdown
- Wide temperature range $T_j = -40^\circ\text{C}$ to 150°C
- Green Product (RoHS compliant)

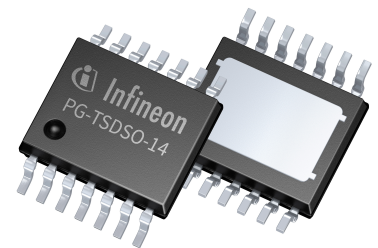

Potential applications

- Body
- ADAS
- Infotainment, telematics
- Navigation

Product validation

Qualified for automotive applications. Product validation according to AEC-Q100.

Description

Description

The OPTIREG™ switcher TLS4120D0EPV is a 2.8 MHz synchronous step down regulator especially designed for automotive applications. The device has a current capability of 2 A, adjustable output voltage and a feedback voltage accuracy of $\pm 1.5\%$ in PWM mode. The integrated power stages, soft-start feature and integrated compensation network reduce the required amount of external components and thus system costs and board space. The wide input voltage range and a 100% duty cycle operation mode make the device suitable for battery cranking scenarios in automotive applications. The wide switching frequency range allows the selection of appropriate coils and capacitors. The switching frequency can be synchronized to an external clock signal. Spread spectrum frequency modulation can be activated to improve the EMI performance in PWM operation. The device offers low current consumption in PFM mode at light loads to optimize efficiency. The TLS4120D0EPV can detect undervoltage and overvoltage conditions of the output voltage and indicates this with the reset output signal. Overcurrent and overload protections avoid excessive current to protect the device during short circuit conditions at the buck converter output. The integrated thermal shutdown feature protects the device from overheating. The enhanced PG-TSDSO-14 exposed pad package offers advantageous thermal performance in the application.

Type	Package	Marking
TLS4120D0EPV	PG-TSDSO-14	4120D0V

Table of contents

Table of contents

	Features	1
	Potential applications	1
	Product validation	1
	Description	2
	Table of contents	3
1	Block diagram	5
2	Pin configuration	6
2.1	Pin assignment	6
2.2	Pin definitions and functions	6
3	General product characteristics	8
3.1	Absolute maximum ratings	8
3.2	Functional range	9
3.3	Thermal resistance	10
4	Buck regulator	11
4.1	Functional description buck regulator	11
4.1.1	Regulation loop and operation modes	11
4.1.1.1	PWM (Pulse Width Modulation) mode	11
4.1.1.2	PFM (Pulse Frequency Modulation) mode	12
4.1.1.3	Continuous conduction mode and discontinuous conduction mode	12
4.1.1.4	High duty cycle operation	13
4.1.2	Power-up and power-down control	14
4.1.2.1	Startup procedure with soft-start	14
4.1.2.2	Active output discharge	14
4.1.3	Protection features	15
4.1.3.1	Overcurrent protection and overload protection	15
4.1.3.2	Input undervoltage shutdown	15
4.1.3.3	Overtemperature protection	15
4.2	Electrical characteristics buck regulator	16
4.3	Typical performance characteristics buck regulator	18
5	Oscillator	27
5.1	Functional description oscillator	27
5.1.1	Synchronization input	27
5.1.2	Spread spectrum	28
5.2	Electrical characteristics oscillator	28
5.3	Typical performance characteristics oscillator	30
6	Current consumption and enable	31

Table of contents

6.1	Functional description current consumption and enable	31
6.2	Electrical characteristics current consumption and enable	31
6.3	Typical performance characteristics current consumption and enable	32
7	Reset	33
7.1	Functional description reset	33
7.2	Electrical characteristics reset	35
7.3	Typical performance characteristics reset	37
8	Application information	38
8.1	Output voltage adjustment	39
8.2	Feedforward capacitor	39
8.3	Layout recommendations	40
8.4	Additional information	40
9	Package information	41
	Revision history	42
	Disclaimer	43

Block diagram

1 Block diagram

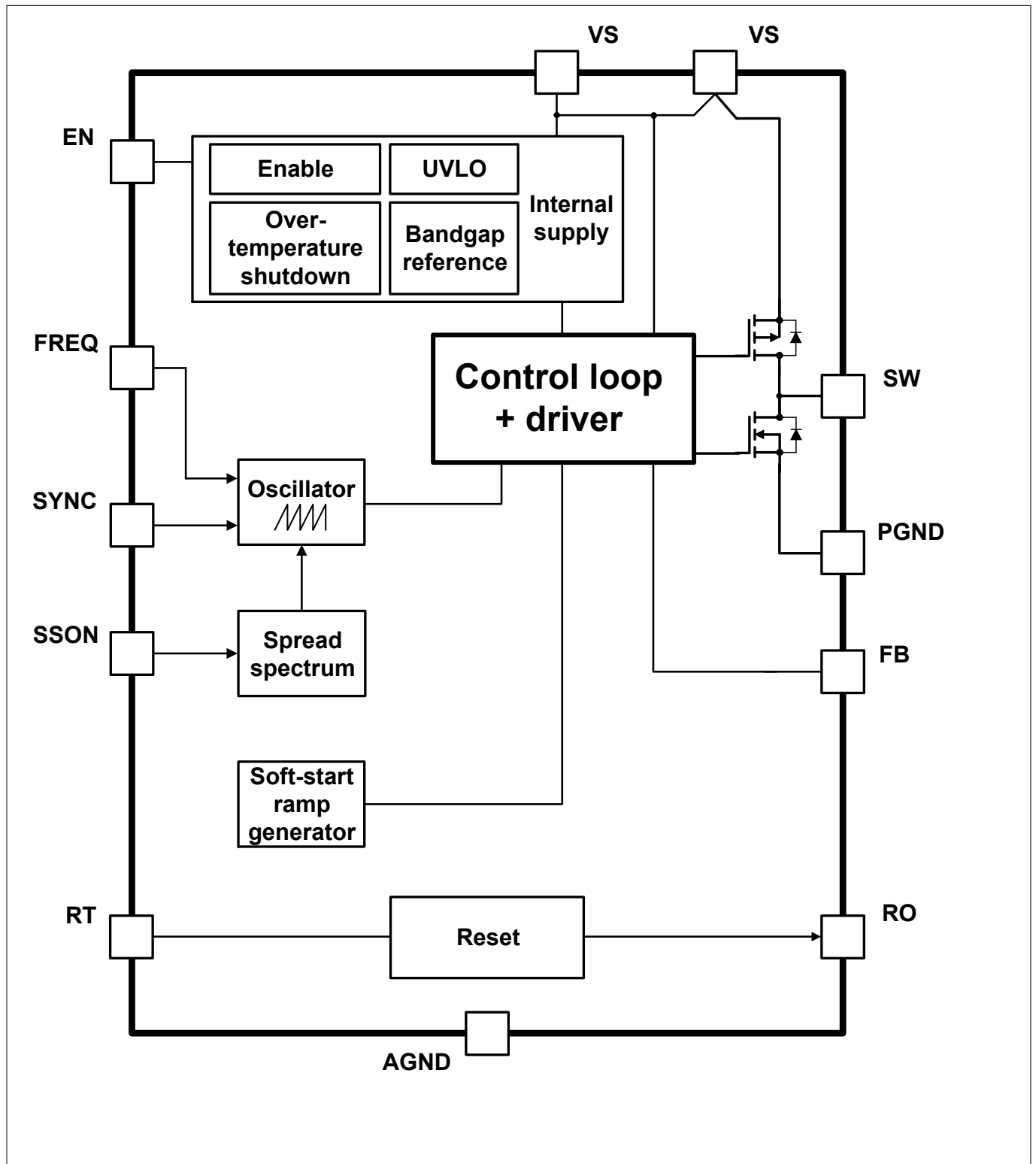

Figure 1 Block diagram

Pin configuration

2 Pin configuration

2.1 Pin assignment

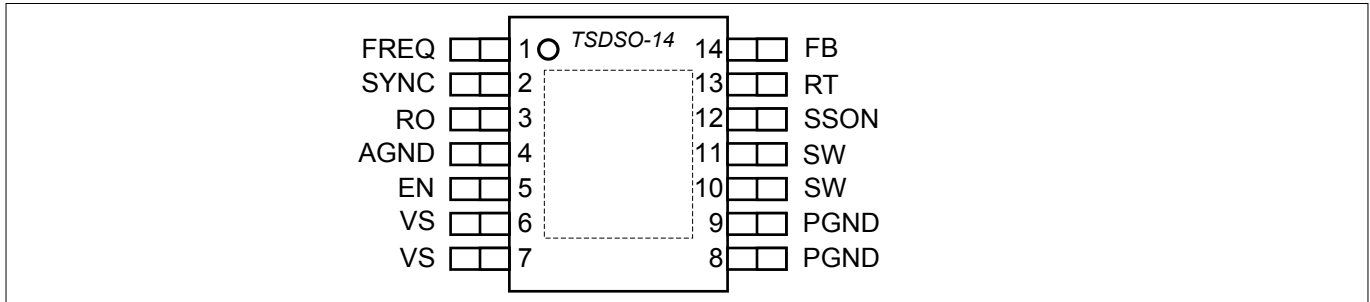

Figure 2 Pin configuration

2.2 Pin definitions and functions

Pin	Symbol	Function
1	FREQ	Frequency selection input: Connect this pin to GND via resistor for frequency selection. Leave this pin open to set the default high switching frequency. Connect this pin to GND to set the default low switching frequency.
2	SYNC	Synchronization input: Connect this pin to external clock to synchronize the switching frequency. If this pin is not used, then connect it to GND.
3	RO	Reset output: Open drain reset output. Provides the reset output signal. If the reset feature is used, then connect this pin via external resistor to V_{CC} or to an external pull-up voltage. If the reset feature is not used, then leave this pin open.
4	AGND	Analog ground: Connect this pin to GND using a low inductive, broad PCB trace.
5	EN	Enable input: This pin has an integrated pull-down resistor. "High" enables the device. "Low" disables the device.
6, 7	VS	Supply voltage input: Connect this pin to supply voltage. Short pins 6 and 7 at the PCB.
8, 9	PGND	Power ground: Connect this pin directly to GND using a low inductive, broad PCB trace. Short pins 8 and 9 at the PCB.
10, 11	SW	Regulator switch node:

Pin configuration

Pin	Symbol	Function
		Connect this pin to the buck converter power inductor. Short pins 10 and 11 at the PCB.
12	SSON	Spread spectrum enable input: This pin has an integrated pull-down resistor. "High" enables spread spectrum. "Low" disables spread spectrum.
13	RT	Reset configuration input: Connect this pin via a resistor to GND to adjust the reset delay time and the reset undervoltage threshold. Connect this pin to GND, if the reset function is not needed or to configure the default reset delay time and default undervoltage reset threshold.
14	FB	Feedback input: Feedback input to the regulator. Connect this pin to the feedback resistor divider tap (see Output voltage adjustment).
-	Exposed pad	Connect the exposed pad to a heatsink area and to GND with low inductive and broad PCB trace.

General product characteristics

3 General product characteristics

3.1 Absolute maximum ratings

Table 1 Absolute maximum ratings¹⁾

$T_j = -40^\circ\text{C}$ to 150°C ; all voltages with respect to ground (unless otherwise specified)

Parameter	Symbol	Values			Unit	Note or condition	Number
		Min.	Typ.	Max.			
Voltages							
Enable input	V_{EN}	-20	–	35	V	–	P_3.1.1
Enable input	$V_{EN,dyn}$	-20	–	42	V	²⁾ Transients present on this pin	P_3.1.2
Synchronization input	V_{SYNC}	-0.3	–	6	V	–	P_3.1.3
Spread spectrum enable input	V_{SSON}	-0.3	–	6	V	–	P_3.1.4
Frequency selection	V_{FREQ}	-0.3	–	6	V	–	P_3.1.5
Reset output	V_{RO}	-0.3	–	6	V	–	P_3.1.6
Reset configuration	V_{RT}	-0.3	–	6	V	–	P_3.1.7
Feedback input	V_{FB}	-0.3	–	1.5	V	–	P_3.1.8
Buck switch output	V_{SW}	-0.3	–	$V_{VS} + 0.3$	V	Minimum -2.0 V in transient condition (single event < 15 ns)	P_3.1.9
Supply voltage input	V_{VS}	-0.3	–	35	V	–	P_3.1.10
Supply voltage input	$V_{VS,dyn}$	-0.3	–	42	V	²⁾ Transients present on this pin	P_3.1.11
Power GND	V_{PGND}	-0.3	–	0.3	V	–	P_3.1.12
Analog GND	V_{AGND}	-0.3	–	0.3	V	–	P_3.1.13
Temperatures							
Junction temperature	T_j	-40	–	150	°C	–	P_3.1.14
Storage temperature	T_{stg}	-55	–	150	°C	–	P_3.1.15
ESD susceptibility							
ESD susceptibility to GND	$V_{ESD,HBM}$	-2	–	2	kV	³⁾ HBM	P_3.1.16
ESD susceptibility to GND	$V_{ESD,CDM}$	-500	–	500	V	⁴⁾ CDM	P_3.1.17

¹ Not subject to production test, specified by design.

² Transients between 35 V and 42 V can be tolerated for a total lifetime duration shorter than 48 s.

³ ESD susceptibility, Human Body Model (HBM) according to ANSI/ESDA/JEDEC JS-001 (1.5 kΩ, 100 pF).

⁴ ESD susceptibility, Charged Device Model (CDM) according to JEDEC JESD22-C101.

General product characteristics

Table 1 Absolute maximum ratings¹⁾ (continued)

$T_j = -40^\circ\text{C}$ to 150°C ; all voltages with respect to ground (unless otherwise specified)

Parameter	Symbol	Values			Unit	Note or condition	Number
		Min.	Typ.	Max.			
ESD susceptibility corner pins 1, 7, 8, 14 to GND	$V_{\text{ESD,CDM,C}}$	-750	–	750	V	⁴⁾ CDM	P_3.1.18

Notes:

1. Stresses above the ones listed here may cause permanent damage to the device. Exposure to absolute maximum rating conditions for extended periods of time may affect device reliability.
2. Integrated protection functions are designed to prevent IC destruction under fault conditions described in the data sheet. Fault conditions are considered as outside the normal operating range. Protection functions are not designed for continuous repetitive operation.

3.2 Functional range

Table 2 Functional range

$T_j = -40^\circ\text{C}$ to 150°C ; all voltages with respect to ground (unless otherwise specified)

Parameter	Symbol	Values			Unit	Note or condition	Number
		Min.	Typ.	Max.			
Supply voltage decreasing	$V_{\text{VS,dec}}$	3.7	–	35	V	⁵⁾ Minimum value represents low battery voltage condition (cranking)	P_3.2.1
Supply voltage increasing	$V_{\text{VS,inc}}$	6.0	–	35	V	Minimum value represents startup condition	P_3.2.2
Enable input	V_{EN}	0	–	35	V	–	P_3.2.3
Output voltage adjust range	V_{CC}	3.0	–	10	V	–	P_3.2.6
SYNC input voltage	V_{SYNC}	0	–	5.2	V	–	P_3.2.9
Reset output voltage	$V_{\text{RO,hi}}$	0	–	5.2	V	⁶⁾	P_3.2.12
Output current	I_{CC}	0	–	2	A	–	P_3.2.14
Junction temperature	T_j	-40	–	150	$^\circ\text{C}$	–	P_3.2.15

¹ Not subject to production test, specified by design.

⁴ ESD susceptibility, Charged Device Model (CDM) according to JEDEC JESD22-C101.

⁵ With $3.7\text{ V} < V_{\text{VS}} < 6\text{ V}$, a reduced performance of parameter settings applies to feedback voltage accuracy, synchronization and the reset function.

⁶ Allowed pull-up voltage applied via pull-up resistance to pin RO.

General product characteristics

Note: Within the functional or operating range, the IC operates as described in the circuit description. The electrical characteristics are specified within the conditions given in the electrical characteristics table.

3.3 Thermal resistance

Table 3 Thermal resistance⁷⁾

Parameter	Symbol	Values			Unit	Note or condition	Number
		Min.	Typ.	Max.			
Junction to case	R_{thJC}	–	8.6	–	K/W	–	P_3.3.1
Junction to ambient	$R_{thJA,1}$	–	34	–	K/W	⁸⁾ 2s2p	P_3.3.2
Junction to ambient	$R_{thJA,2}$	–	45	–	K/W	⁹⁾ 1s0p + 600 mm ²	P_3.3.3
Junction to ambient	$R_{thJA,3}$	–	54	–	K/W	⁹⁾ 1s0p + 300 mm ²	P_3.3.4
Junction to ambient	$R_{thJA,4}$	–	116	–	K/W	⁹⁾ 1s0p footprint	P_3.3.5

Note: This thermal data was generated in accordance with JEDEC JESD51 standards. For more information visit www.jedec.org.

⁷⁾ Not subject to production test, specified by design.

⁸⁾ Specified R_{thJA} value is according to JEDEC JESD51-2,-5,-7 at natural convection on FR4 2s2p board; the product (chip and package) was simulated on a 76.2 × 114.3 × 1.5 mm³ board with two inner copper layers (2 × 70 μm Cu, 2 × 35 μm Cu). Where applicable, a thermal via array next to the package contacted the first inner copper layer.

⁹⁾ Specified R_{thJA} value is according to JEDEC JESD 51-3 at natural convection on FR4 1s0p board; the product (IC and package) was simulated on a 76.2 × 114.3 × 1.5 mm³ board with 1 copper layer (1 × 70 μm Cu).

Buck regulator

4 Buck regulator

4.1 Functional description buck regulator

The TLS4120D0EPV is a synchronous current mode step down (buck) regulator with selectable switching frequency f_{OSC} . The device regulates the output voltage in pulse width modulation (PWM) or in pulse frequency modulation (PFM) mode and automatically moves between both modes on load change or input voltage change. At low input voltage conditions, for example during battery cranking, the device can operate at a duty cycle of 100%.

4.1.1 Regulation loop and operation modes

Figure 3 shows the regulation loop. An external resistor divider is connected between V_{CC} and AGND. The intermediate point V_{FB} is connected to pin FB. The error amplifier processes the difference between scaled output feedback voltage and internal reference voltage to provide a reference current to the PWM comparator. The PWM comparator compares that reference current to a scaled version of the inductor current to determine the PWM duty cycle that is required for stable output voltage regulation. In PFM mode the error amplifier output signal also serves to modulate the switching frequency.

The control logic supervises the handover between operation modes and triggers the drivers of high side PMOS power stage and the low side NMOS power stage accordingly. For the modes of PWM, PFM and 100% duty cycle operation see **PWM (Pulse Width Modulation) mode**, **PFM (Pulse Frequency Modulation) mode**, **Continuous conduction mode and discontinuous conduction mode** and **High duty cycle operation** respectively.

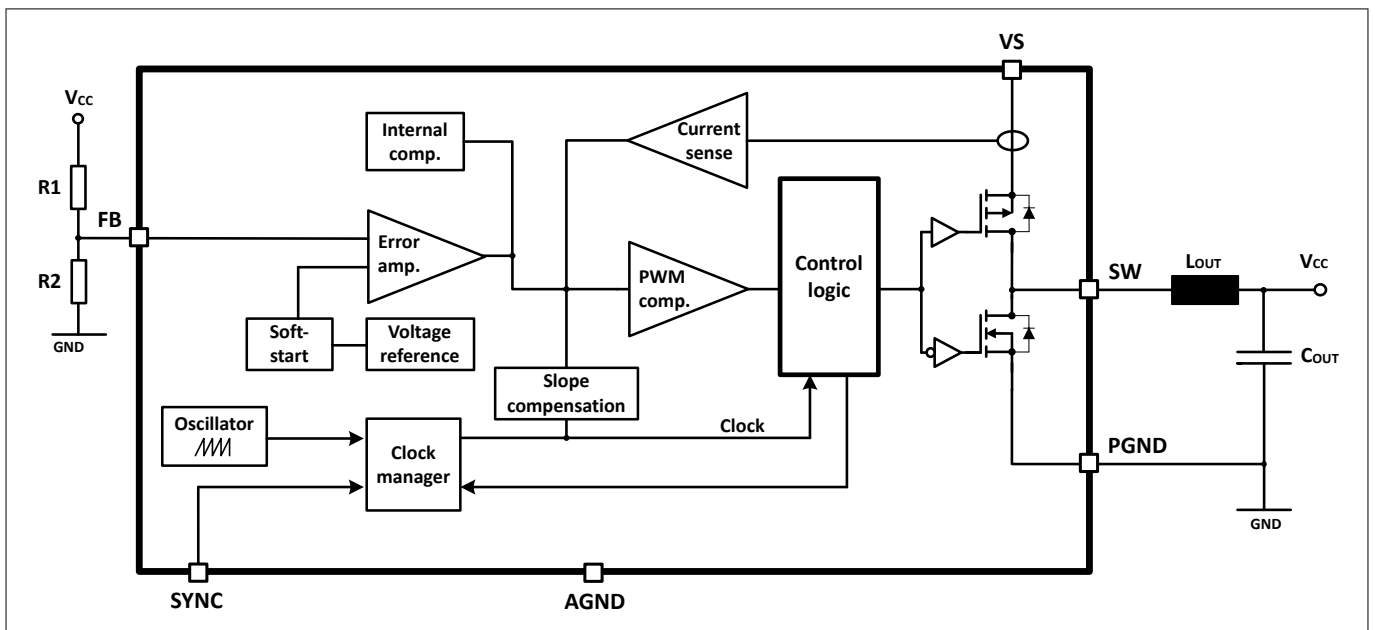

Figure 3 Functional block diagram buck regulator

4.1.1.1 PWM (Pulse Width Modulation) mode

At high load the TLS4120D0EPV operates with the configured switching frequency f_{OSC} in PWM mode. In PWM mode the device modulates the duty cycle to achieve a regulated output voltage. The nominal switching frequency can be set using one of the following methods, see **Oscillator**:

- by an external resistor connected at pin **FREQ**
- from a synchronization signal applied at the **SYNC** pin

The pulse width modulation is based on peak current mode detection to achieve a fast reaction time and an optimized feedback accuracy. The PWM comparator processes the current signal detected at the high

Buck regulator

side power stage as well as the current signals of the slope compensation and the error amplifier to adjust the switching duty cycle to regulate the output voltage accordingly. With a duty cycle above 50% the slope compensation ensures system stability. This is achieved by avoidance of subharmonic oscillations of the output inductor current.

Due to a current sense signal inaccuracy at the beginning of each high side switch conduction phase, a short blanking time is required to mask the output of the current sense before processing it. The blanking time defines the minimum allowed on-time $t_{on,min}$ of the high side PMOS power stage and therefore the point of transition from PWM to PFM operation.

4.1.1.2 PFM (Pulse Frequency Modulation) mode

The device can operate at constant on-time $t_{on,min}$ of the high side PMOS power stage to achieve a stable output voltage at light load or high input voltage conditions. In PFM mode the device operates at a constant on-time and modulates the switching frequency to regulate the output voltage. The switching frequency is lower than in PWM mode. For further information about the PFM boundary condition and the frequency modulation depending on load and on input voltage, see [Typical performance characteristics buck regulator](#).

In PFM mode with light load the device offers optimized efficiency with reduced current consumption.

4.1.1.3 Continuous conduction mode and discontinuous conduction mode

Continuous conduction mode (CCM)

The device operates at a continuously rising or falling triangular positive inductor current. The on-time and the switching duty cycle mainly depend on the ratio of output voltage to input voltage.

Boundary condition for CCM → DCM transition

With a decrease of the load current during continuous conduction mode, the minimum valley inductor current can obtain approximately zero, which is the boundary condition for the discontinuous conduction mode. Further reduction of the load current leads to discontinuous conduction mode.

Discontinuous conduction mode (DCM)

The device turns off the low side power stage to avoid a negative inductor current. Further reduction of the load current reduces the on-time and leads to transition from PWM into PFM when obtaining the minimum on-time.

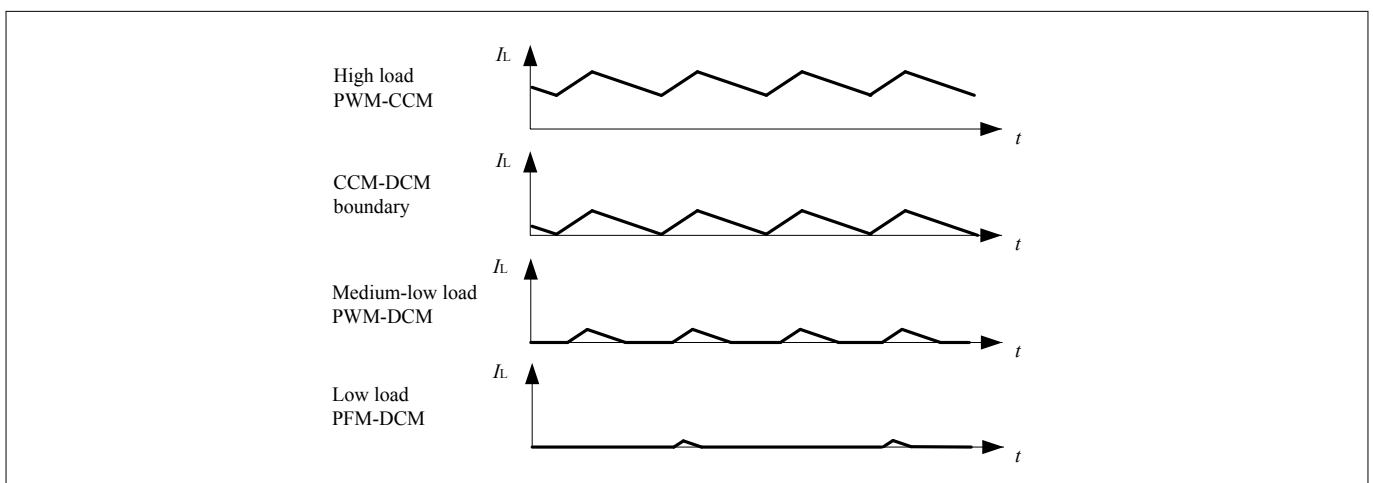

Figure 4 Typical example inductor current waveforms for CCM and DCM

Buck regulator

4.1.1.4 High duty cycle operation

In 100% duty cycle mode the high side PMOS power stage constantly conducts current. If the input voltage is close to the nominal output voltage or lower, then the device enters this operation mode, see [Figure 5](#).

If the input voltage is decreased (for example during a battery cranking scenario) and the device moves from regulation to the 100% duty cycle mode, then the output voltage tracks the input voltage as accurate as possible down to an input voltage V_{VS} of 3.7 V. During steady state operation, the difference of the output voltage and the tracked input voltage as well as the entry point into 100% duty cycle mainly depend on the voltage drop at the resistance $R_{on,hs}$ of the high side PMOS power stage, which in turn depends on the load current I_{CC} . Parasitic elements of external application circuitry and components, such as the output inductor series resistance, increase the voltage drop.

At high duty cycles close to 100%, the loop might not propagate very short off-times and compensates this by skipping switching cycles to ensure a smooth transition to 100% duty cycle with a stable output voltage.

Commonly, regulators with adjustable output voltage are more sensitive towards noise injected into the feedback path due to the external resistor divider. The current sense signal processing for accurate peak current detection may reach its resolution limit at high duty cycles close to 100% due to low peak to peak inductor currents. Therefore an optimized PCB layout and suitable external components are crucial to avoid irregular cycles of the switching frequency and to maintain a stable output voltage.

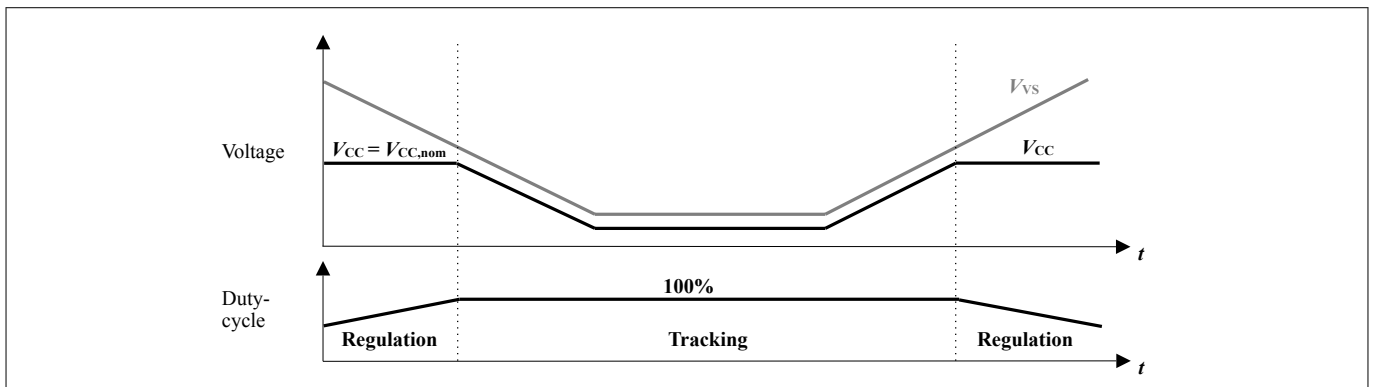

Figure 5 Typical 100% duty cycle mode tracking behavior

Buck regulator

4.1.2 Power-up and power-down control

The following features of the device control power up and power down, see [Table 4](#) for electrical characteristics:

- Startup with soft-start
- Active output discharge

4.1.2.1 Startup procedure with soft-start

The soft-start function of the TLS4120D0EPV controls the ramp-up of the output voltage with defined timing t_{start} during startup, see [Figure 6](#). If $V_{VS} > V_{VS,on}$, then a "high" signal $V_{EN,hi}$ at pin EN triggers the startup procedure. During startup the internal supply establishes a stable state and the device initializes the switching frequency and the reset function according to the configuration. The regulator then increases the output voltage V_{CC} by ramping up the internal voltage reference connected to the error amplifier.

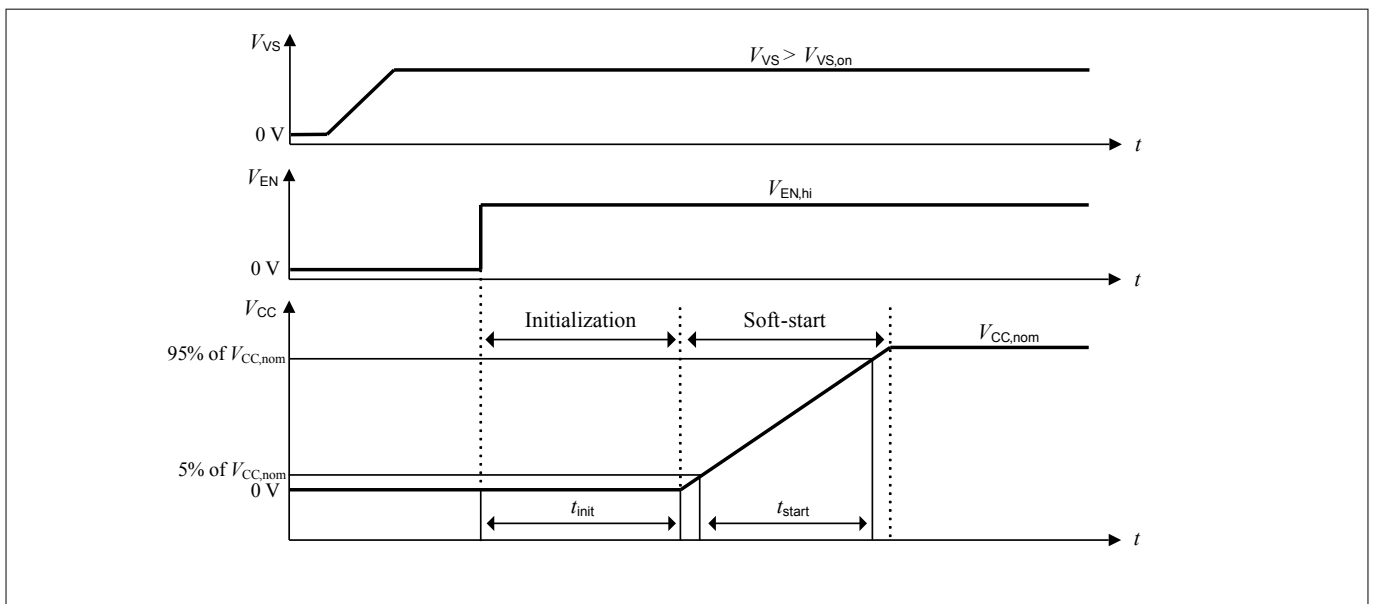

Figure 6 Typical startup procedure

4.1.2.2 Active output discharge

The active output discharge function of the TLS4120D0EPV controls the ramp-down of the output voltage during power down, see [Figure 7](#). If the device detects a "low" signal $V_{EN,lo}$ at the EN pin, then it switches on the integrated discharge transistor connected to the SW pin in order to discharge the output capacitor C_{OUT} via the output inductor L_{OUT} . The typical on-resistance R_{dc} of the discharge transistor is 55 Ω .

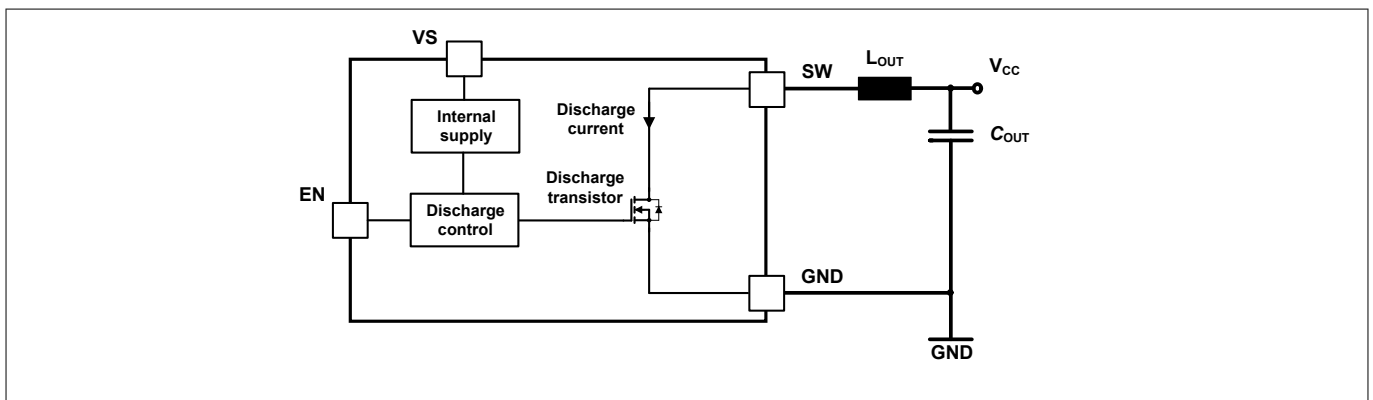

Figure 7 Active output discharge block diagram

Buck regulator

4.1.3 Protection features

The device offers features that are designed to protect it from fault events such as overcurrent, overload, input undervoltage and overtemperature, see [Table 4](#).

4.1.3.1 Overcurrent protection and overload protection

If the sensed current through the high side PMOS power stage exceeds the buck peak overcurrent limit I_{BUOC} after the blanking time of the current sense, then the device switches off the high side power stage for the remaining time of the current cycle. Active current limitation can decrease the output voltage level.

If the sensed freewheeling current through the low side NMOS power stage exceeds the overload limit I_{BUOL} , then the device prevents the high side PMOS power stage from switching on in the subsequent clock cycles to avoid overheating. The overload threshold level is set to a higher value than the overcurrent threshold level.

If an overload condition and an undervoltage condition occur for longer than 3 ms typically, then the device detects a short circuit at the output voltage node and shuts down. After a waiting time of typically 1 s, the device restarts with a soft-start.

4.1.3.2 Input undervoltage shutdown

The device incorporates an undervoltage shutdown function. If the input voltage V_{VS} drops below the input undervoltage shutdown threshold $V_{VS,off}$, then the device shuts down.

4.1.3.3 Overtemperature protection

The integrated overtemperature protection turns off the device in case of a too high junction temperature. The typical junction thermal shutdown temperature is 175°C. After the device has cooled down by the amount of the typical junction temperature hysteresis 10 K and a subsequent waiting time of typically 1 s, the device restarts with a soft-start to resume normal operation. The thermal shutdown is an integrated protection function to prevent the immediate destruction of the device during fault conditions. However, a junction temperature above 150°C is outside of the maximum ratings and reduces the lifetime of the device.

Buck regulator

4.2 Electrical characteristics buck regulator

Table 4 Electrical characteristics buck regulator

$V_{VS} = 6\text{ V to }35\text{ V}$; $T_j = -40^\circ\text{C to }150^\circ\text{C}$; all voltages with respect to ground (unless otherwise specified)

Parameter	Symbol	Values			Unit	Note or condition	Number
		Min.	Typ.	Max.			
Feedback voltage accuracy							
Feedback voltage accuracy	$V_{FB,PWM}$	-1.5	-	+1.5	%	$6\text{ V} \leq V_{VS} \leq 35\text{ V}$; PWM mode	P_4.2.1
Feedback voltage accuracy	$V_{FB,PFM,1}$	-2	-	+3.5	%	$6\text{ V} \leq V_{VS} \leq 35\text{ V}$; PFM mode	P_4.2.2
Feedback voltage V_{FB}	V_{FB}	-	0.8	-	V	-	P_4.2.5
MOSFETs							
High side MOSFET on-resistance	$R_{on,hs}$	-	120	240	m Ω	$I_{CC} = 100\text{ mA}$	P_4.2.7
Low side MOSFET on-resistance	$R_{on,ls}$	-	70	150	m Ω	$I_{CC} = 100\text{ mA}$	P_4.2.9
Regulation loop							
Maximum duty cycle	D_{max}	-	-	100	%	¹⁰⁾	P_4.2.11
Minimum on-time, high frequency	$t_{on,min,hf}$	-	78	-	ns	¹¹⁾ $I_{CC} = 1.5\text{ A}$; valid for high frequency operation range	P_4.2.12
Minimum on-time, low frequency	$t_{on,min,lf}$	-	308	-	ns	¹¹⁾ $I_{CC} = 1.5\text{ A}$; valid for low frequency operation range	P_4.2.13
Startup and active discharge¹²⁾							
Soft-start time	t_{start}	0.8	1	1.2	ms	V_{CC} rising from 5% to 95% of nominal V_{CC} level	P_4.2.14
Startup initialization time	t_{init}	-	-	2.6	ms	time from rising edge of V_{EN} (0 V to $V_{EN,hi}$) until soft-start	P_4.2.15
Input voltage startup threshold	$V_{VS,on}$	2.6	-	6.0	V	V_{VS} increasing; $V_{EN} \geq 2\text{ V}$	P_4.2.16
Output discharge resistance	R_{dc}	-	55	-	Ω	$V_{EN} = 0\text{ V}$; $V_{VS} = 13.5\text{ V}$; $V_{SW} = 100\text{ mV}$	P_4.2.17
Current limitation							
Buck peak overcurrent limit	I_{BUOC}	2.8	3.4	4.0	A	-	P_4.2.18

¹⁰ See **Functional range** and **High duty cycle operation**.

¹¹ Specified by design, not subject to production test.

¹² See **Power-up and power-down control**

Buck regulator

Table 4 Electrical characteristics buck regulator (continued)

$V_{VS} = 6\text{ V to }35\text{ V}$; $T_j = -40^\circ\text{C to }150^\circ\text{C}$; all voltages with respect to ground (unless otherwise specified)

Parameter	Symbol	Values			Unit	Note or condition	Number
		Min.	Typ.	Max.			
Overload current limit	I_{BUOL}	3.4	3.9	4.4	A	–	P_4.2.20
Overload overcurrent gap	$I_{BUOL,gap}$	0.05	0.5	–	A	Overload current limit is typically 0.5 A above buck peak overcurrent limit	P_4.2.22
Undervoltage shutdown							
Input undervoltage shutdown threshold	$V_{VS,off}$	3.3	–	3.55	V	V_{VS} decreasing	P_4.2.23
Input undervoltage shutdown hysteresis	$V_{VS,hys}$	180	280	420	mV	–	P_4.2.24

Buck regulator

4.3 Typical performance characteristics buck regulator

FREQ: 2.2 MHz; $V_{VS} = 13.5\text{ V}$; $T_j = 25^\circ\text{C}$ (if not otherwise specified). The shown performance characteristics was measured on a 4 layer FR4 printed circuit board with external components as recommended in [Application information](#).

Efficiency

FREQ: 440 kHz; $T_j = 25^\circ\text{C}$; $V_{CC} = 5\text{ V}$

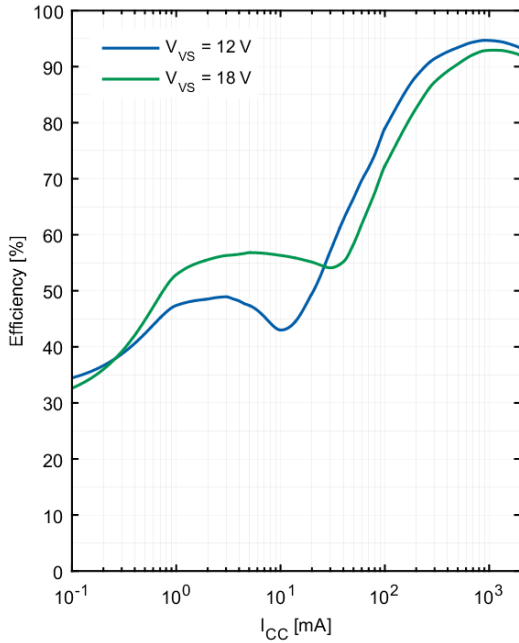

Efficiency

FREQ: 440 kHz; $T_j = 25^\circ\text{C}$; $V_{CC} = 5\text{ V}$

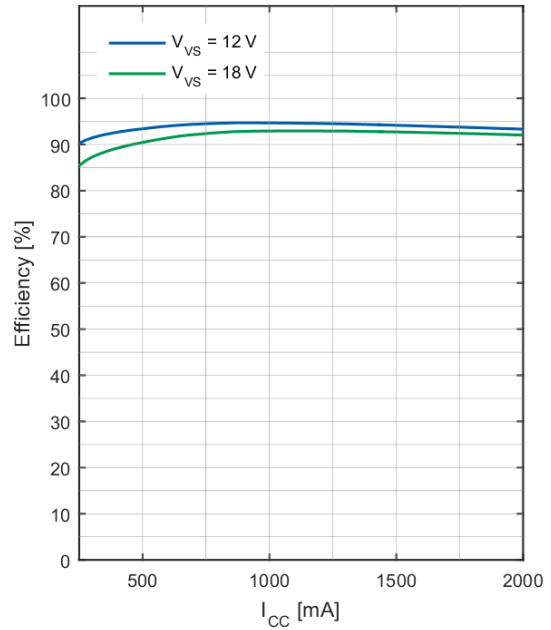

Efficiency

FREQ: 2.2 MHz; $T_j = 25^\circ\text{C}$; $V_{CC} = 5\text{ V}$

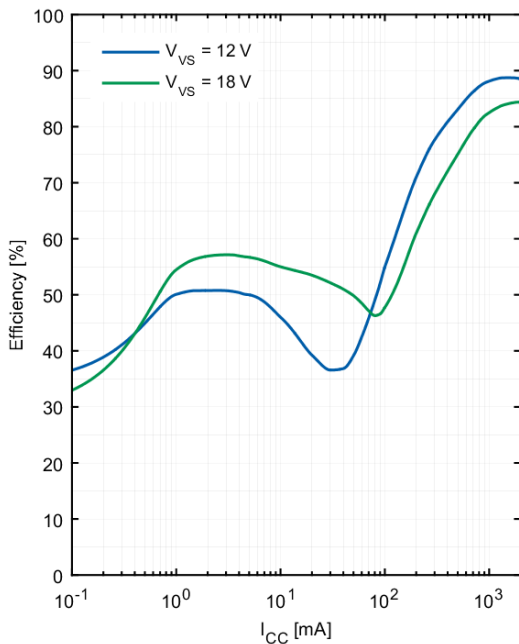

Efficiency

FREQ: 2.2 MHz; $T_j = 25^\circ\text{C}$; $V_{CC} = 5\text{ V}$

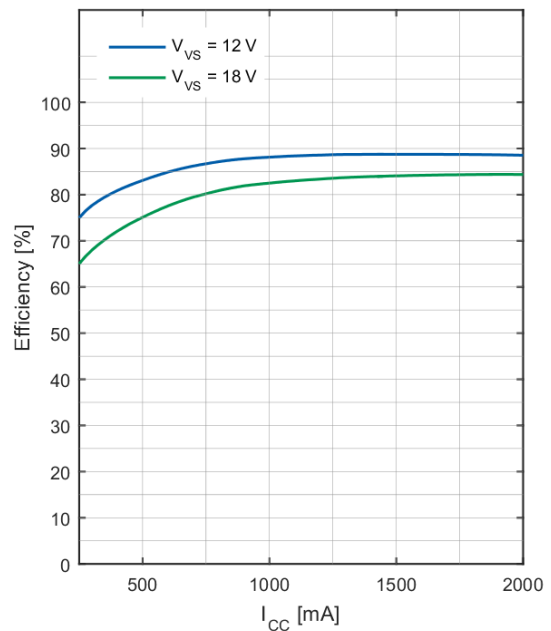

Buck regulator

Efficiency

FREQ: 440 kHz; $T_j = 25^\circ\text{C}$; $V_{CC} = 3.3\text{ V}$

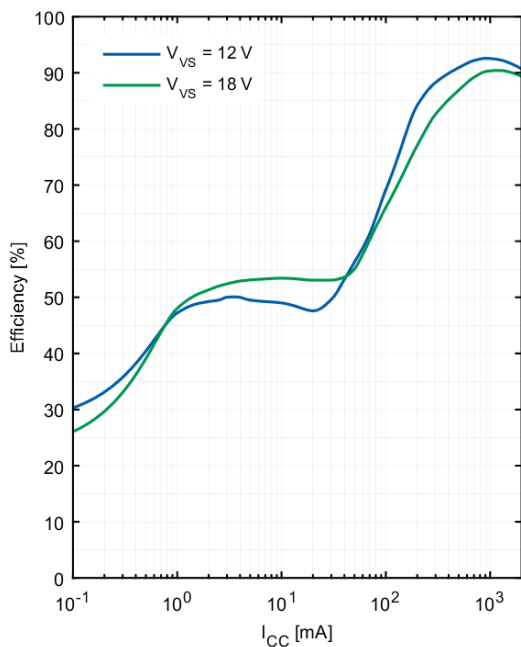

Efficiency

FREQ: 440 kHz; $T_j = 25^\circ\text{C}$; $V_{CC} = 3.3\text{ V}$

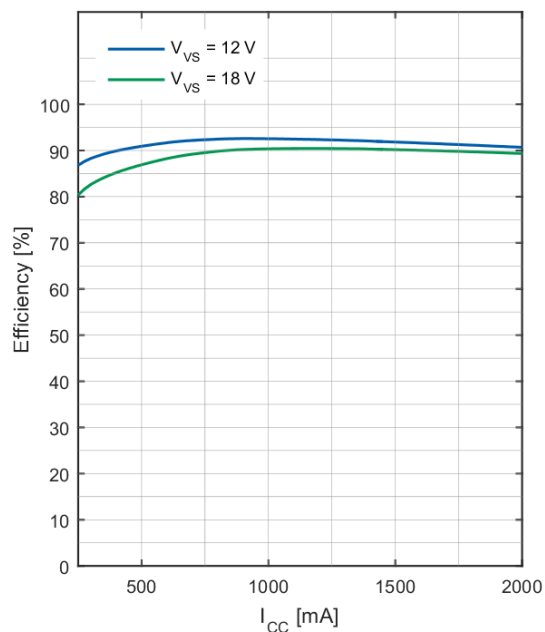

Efficiency

FREQ: 2.2 MHz; $T_j = 25^\circ\text{C}$; $V_{CC} = 3.3\text{ V}$

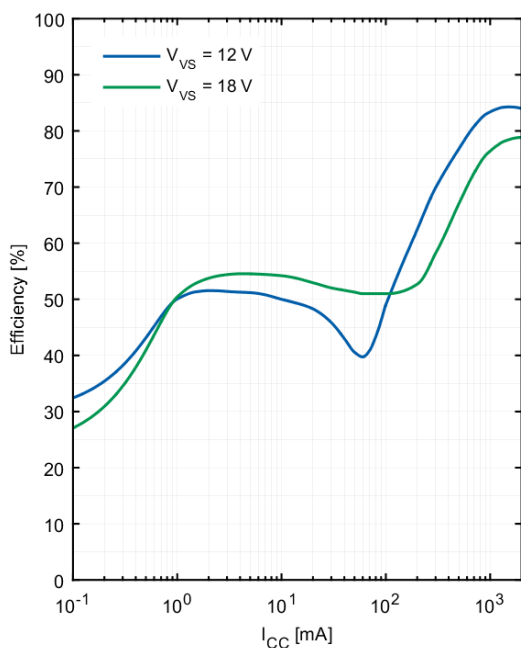

Efficiency

FREQ: 2.2 MHz; $T_j = 25^\circ\text{C}$; $V_{CC} = 3.3\text{ V}$

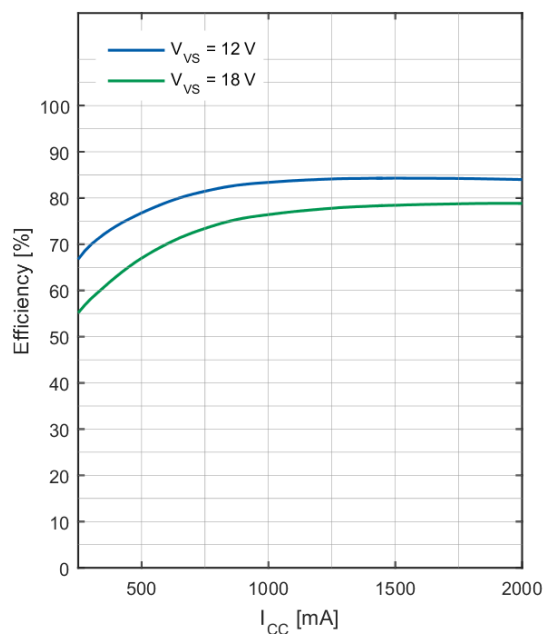

Buck regulator

Line regulation

$I_{CC} = 1\text{ A}$; $V_{CC} = 5\text{ V}$

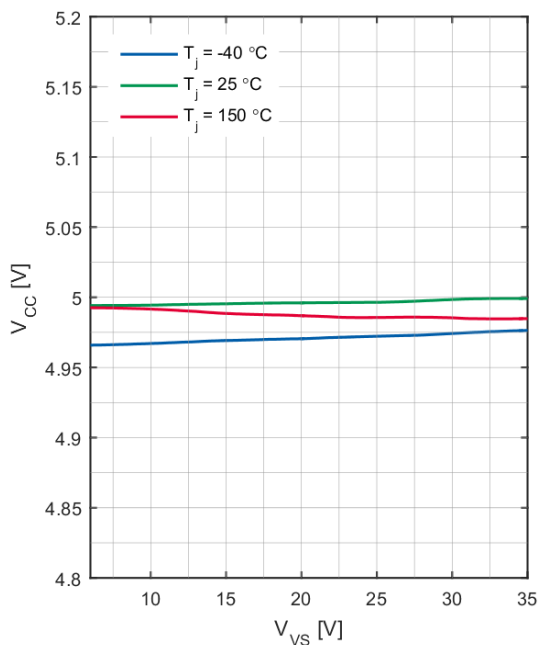

Load regulation

$V_{VS} = 13.5\text{ V}$; $V_{CC} = 5\text{ V}$

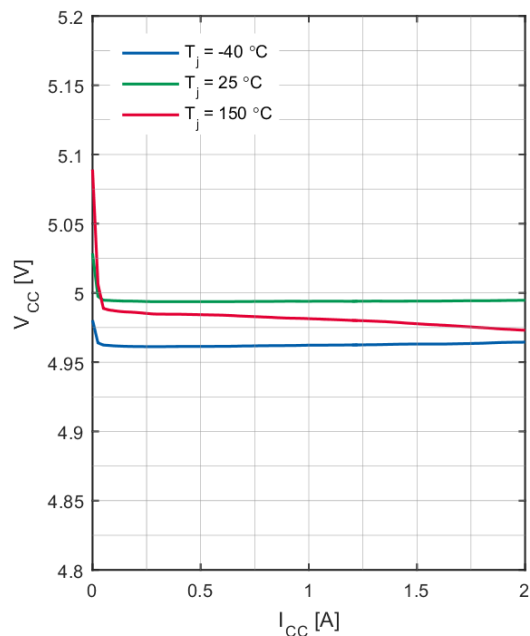

Line regulation

$I_{CC} = 1\text{ A}$; $V_{CC} = 3.3\text{ V}$

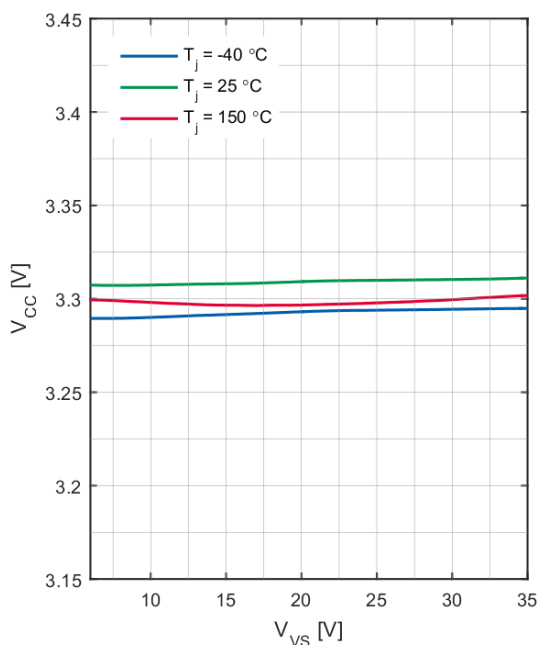

Load regulation

$V_{VS} = 13.5\text{ V}$; $V_{CC} = 3.3\text{ V}$

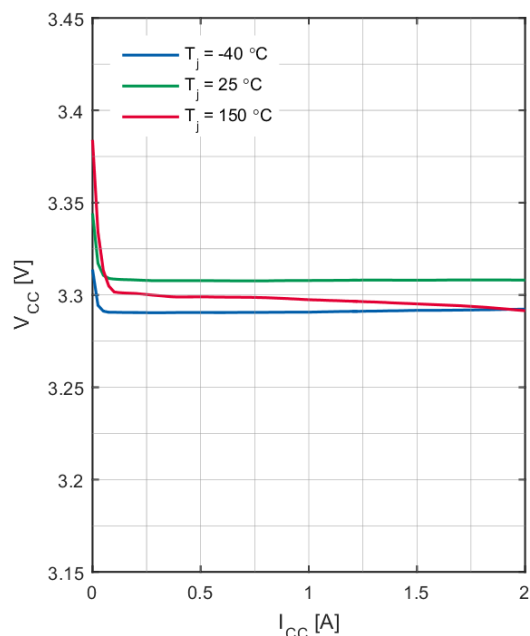

Buck regulator

Output voltage precision

$I_{CC} = 200 \text{ mA}$; $V_{CC} = 5 \text{ V}$

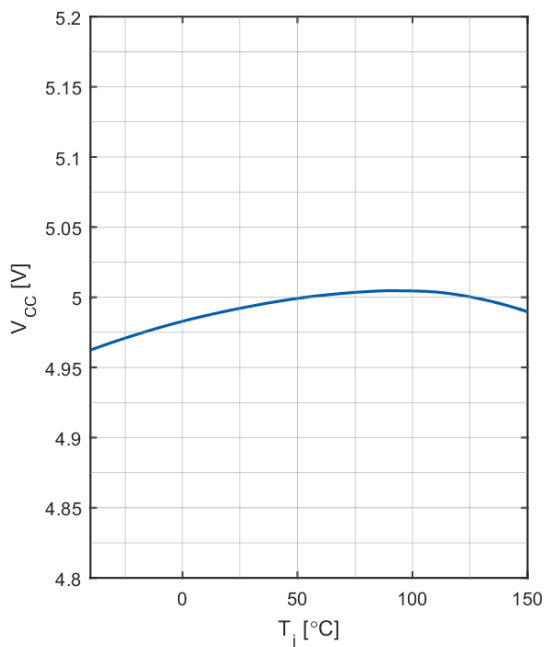

Output voltage precision

$I_{CC} = 200 \text{ mA}$; $V_{CC} = 3.3 \text{ V}$

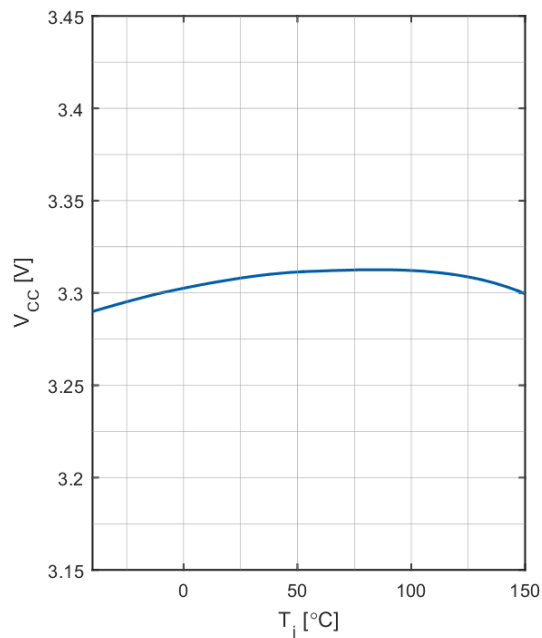

Line regulation (low load)

$I_{CC} = 100 \mu\text{A}$; $V_{CC} = 5 \text{ V}$

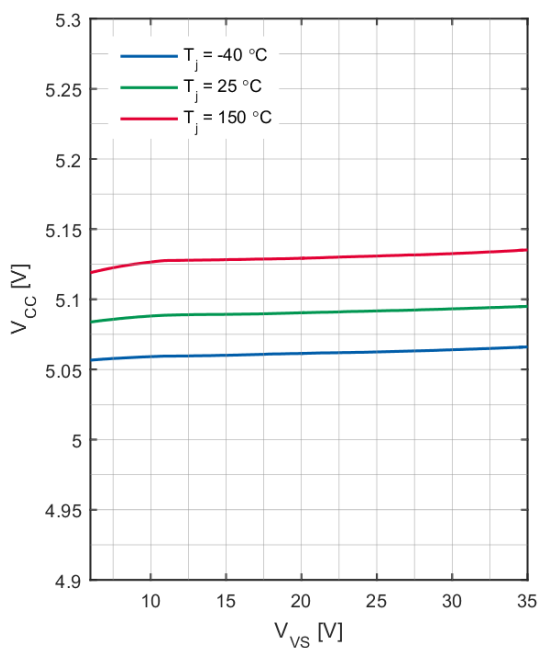

Line regulation (low load)

$I_{CC} = 100 \mu\text{A}$; $V_{CC} = 3.3 \text{ V}$

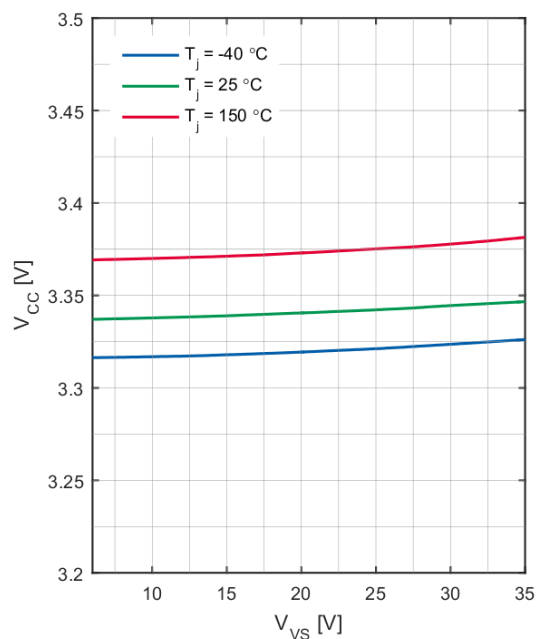

Buck regulator

High side MOSFET on-resistance

$I_{CC} = 100 \text{ mA}$

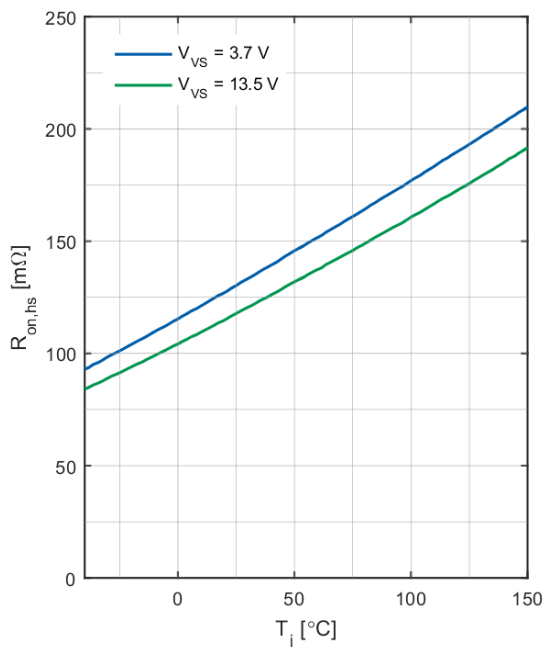

Low side MOSFET on-resistance

$I_{CC} = 100 \text{ mA}$

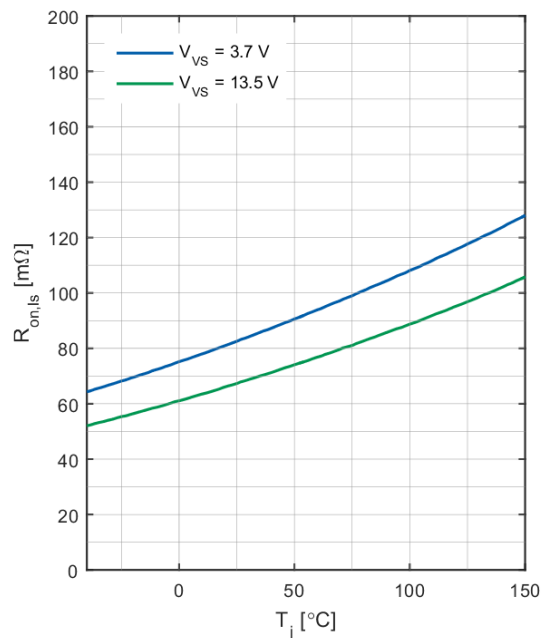

Output discharge resistance

$V_{EN} = 0 \text{ V}; V_{SW} = 100 \text{ mV}$

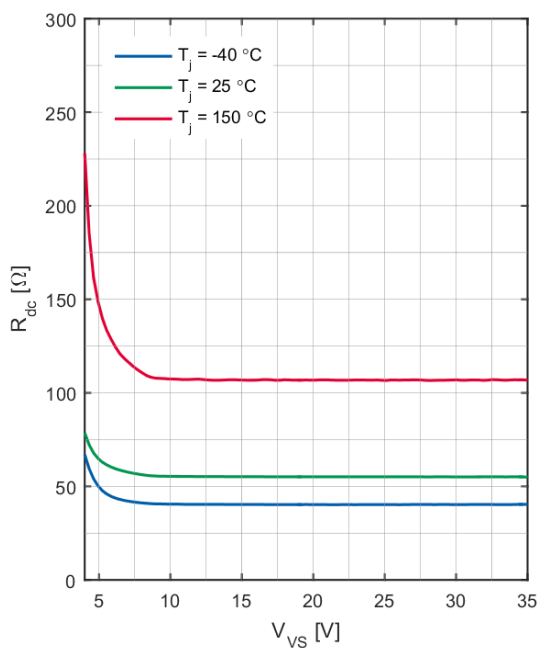

Input undervoltage shutdown threshold

V_{VS} decreasing

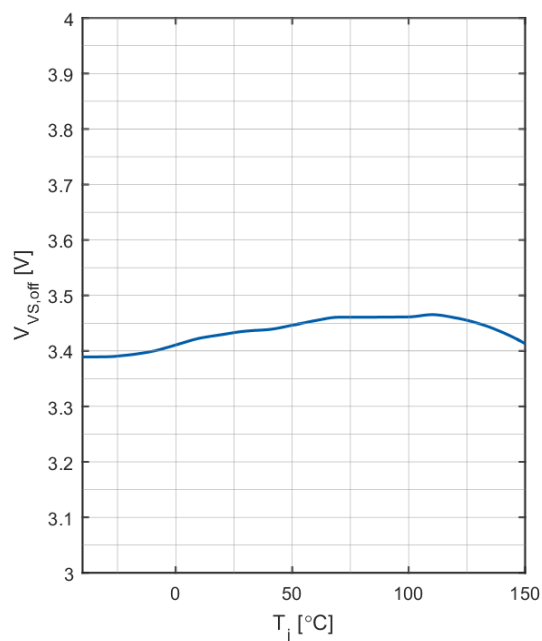

Buck regulator

PFM frequency modulation (CCM)

FREQ: 440 kHz; $I_{CC} = 1.5\text{ A}$; $V_{CC} = 5\text{ V}$

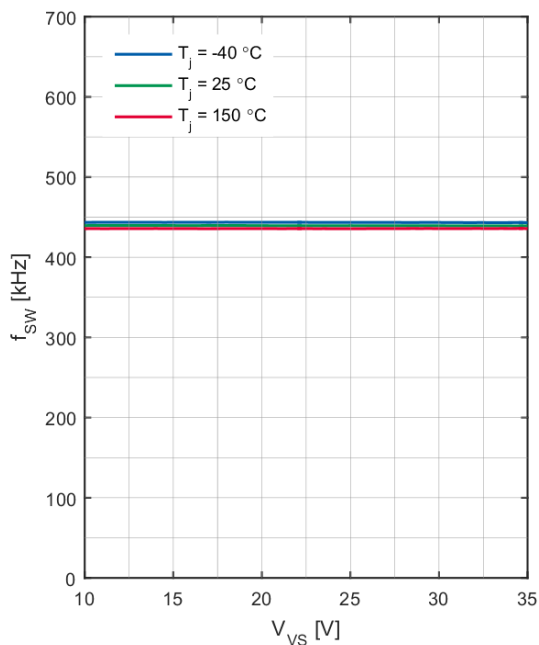

PFM frequency modulation (CCM)

FREQ: 2.2 MHz; $I_{CC} = 1.5\text{ A}$; $V_{CC} = 5\text{ V}$

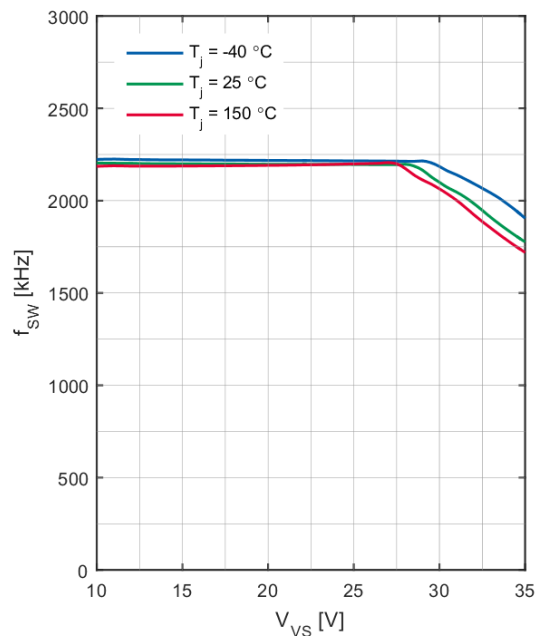

PFM frequency modulation (DCM)

FREQ: 440 kHz; $T_j = 25\text{ °C}$; $V_{CC} = 5\text{ V}$

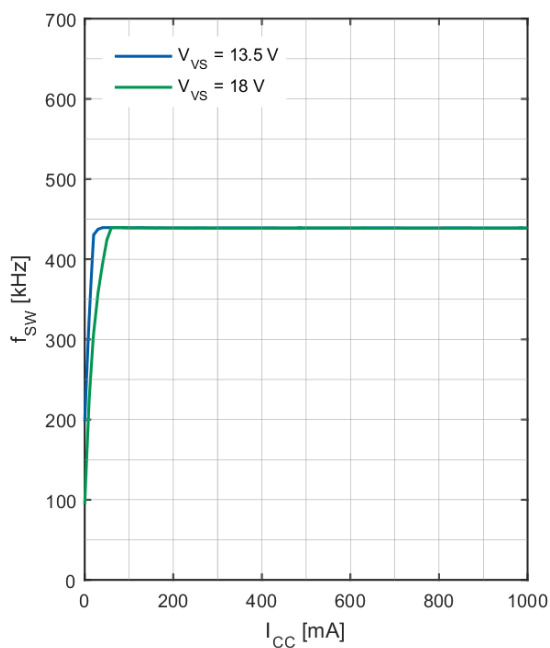

PFM frequency modulation (DCM)

FREQ: 2.2 MHz; $T_j = 25\text{ °C}$; $V_{CC} = 5\text{ V}$

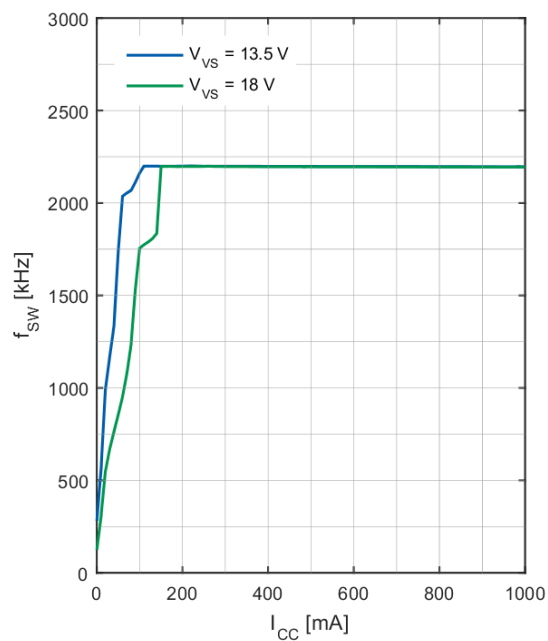

Buck regulator

PFM frequency modulation (CCM)
 FREQ: 440 kHz; $I_{CC} = 1.5\text{ A}$; $V_{CC} = 3.3\text{ V}$

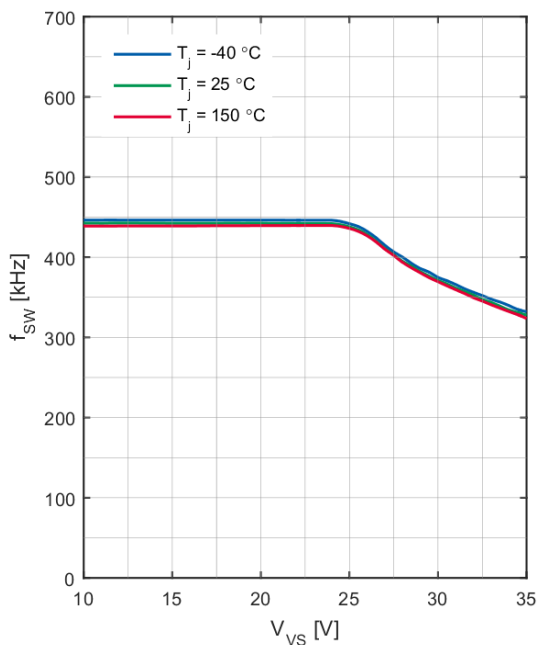

PFM frequency modulation (CCM)
 FREQ: 2.2 MHz; $I_{CC} = 1.5\text{ A}$; $V_{CC} = 3.3\text{ V}$

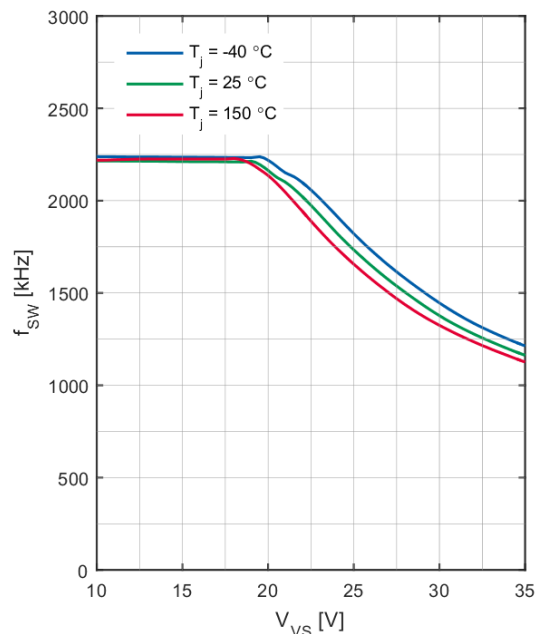

PFM frequency modulation (DCM)
 FREQ: 440 kHz; $T_j = 25\text{ °C}$; $V_{CC} = 3.3\text{ V}$

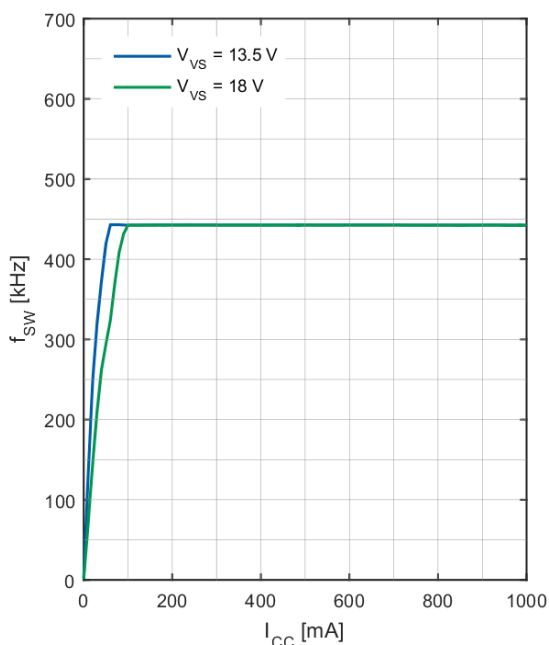

PFM frequency modulation (DCM)
 FREQ: 2.2 MHz; $T_j = 25\text{ °C}$; $V_{CC} = 3.3\text{ V}$

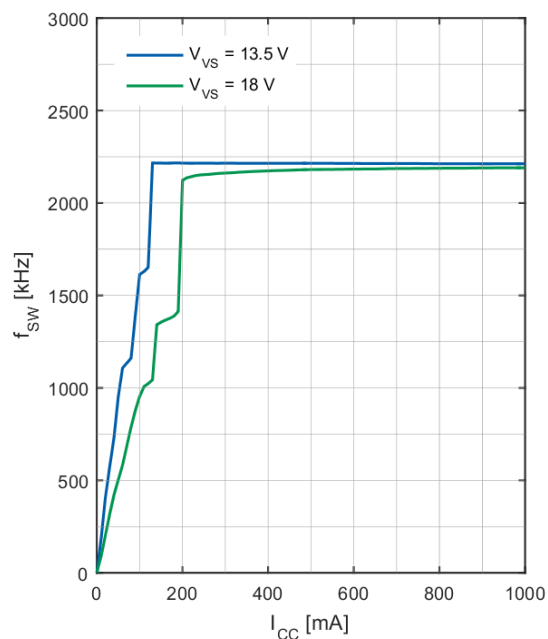

Buck regulator

PFM boundary

$T_j = 25^\circ\text{C}; V_{CC} = 3.3\text{ V}$

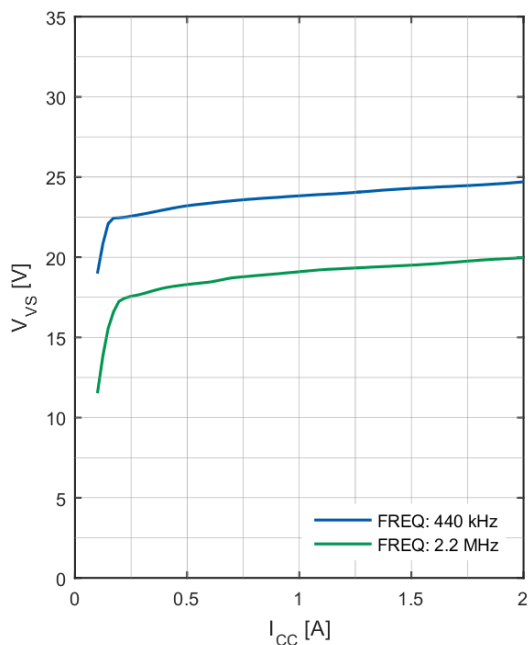

PFM boundary

$T_j = 25^\circ\text{C}; V_{CC} = 5\text{ V}$

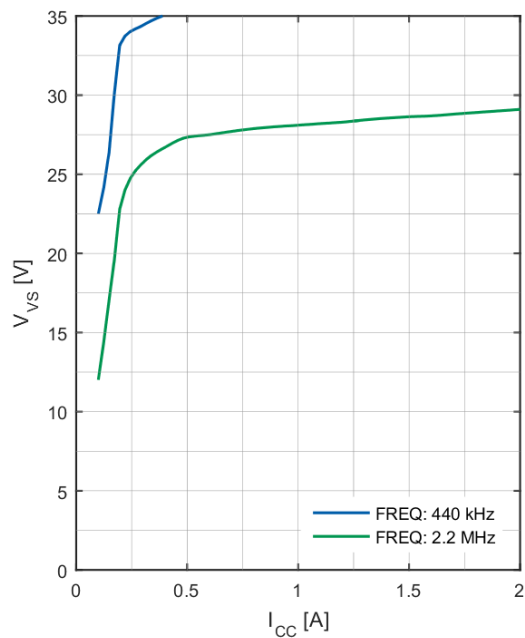

Buck peak overcurrent limit

$V_{VS} = 13.5\text{ V}$

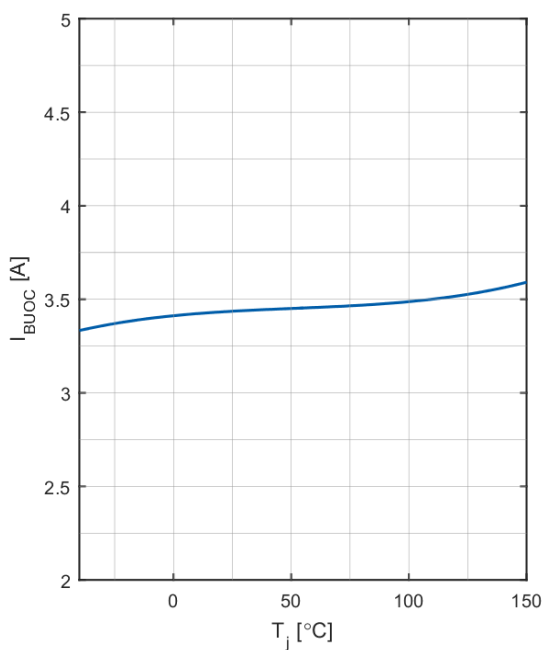

Overload current limit

$V_{VS} = 13.5\text{ V}$

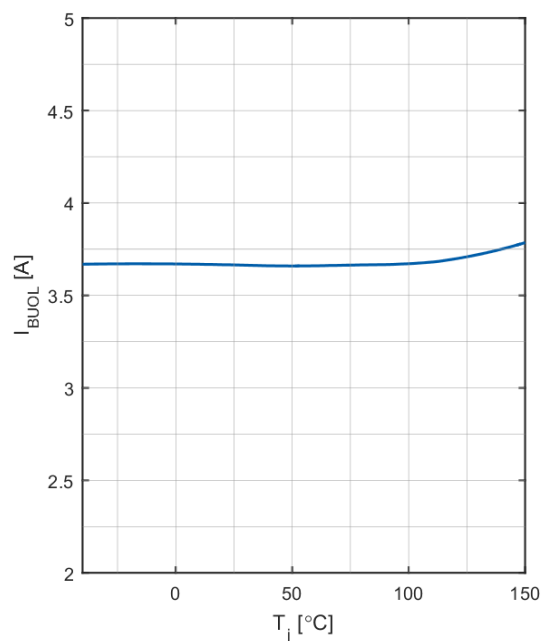

Buck regulator

Load step response

I_{CC} : 0.6 A to 2 A to 0.6 A; V_{CC} = 5 V

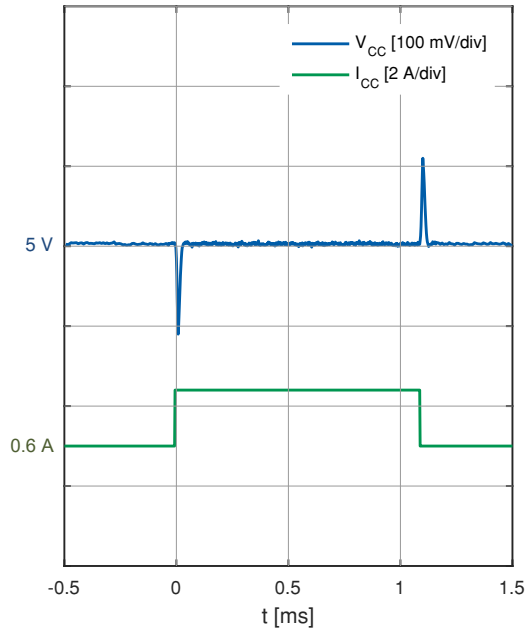

Load step response

I_{CC} : 0.6 A to 2 A to 0.6 A; V_{CC} = 3.3 V

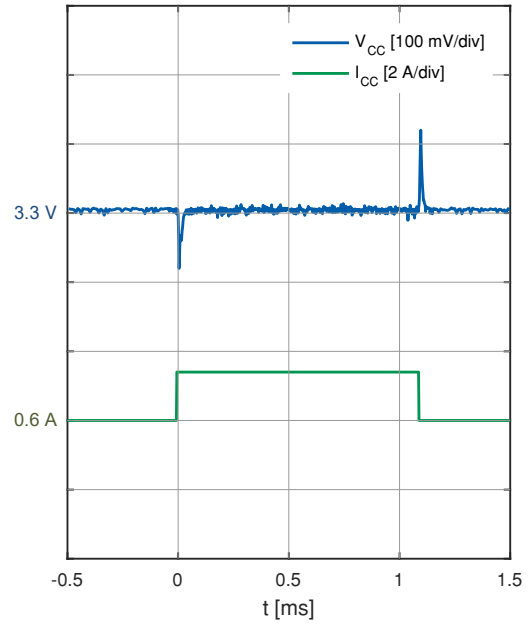

Oscillator

5 Oscillator

5.1 Functional description oscillator

The integrated clock provides a constant frequency to the regulation loop. In PWM mode the device switches on and off the high side and low side power stages at the oscillator frequency f_{OSC} .

The oscillator frequency can be set by connecting a resistor R_{FREQ} between the FREQ pin and ground, see [Table 5](#), [Table 6](#) and [Table 7](#). The device sets the selected switching frequency during startup.

Table 5 FREQ configuration for typical oscillator frequencies in the low frequency range

R_{FREQ} [k Ω] ¹³⁾	f_{Osc} [kHz]
2.2	320
3.3	360
4.7	400
≤ 1.0 (or connect FREQ pin directly to GND)	440 ¹⁴⁾
6.8	480
10	520
15	560

Table 6 FREQ configuration for typical oscillator frequencies in the high frequency range

R_{FREQ} [k Ω] ¹⁵⁾	f_{Osc} [MHz]
22	1.6
33	1.8
47	2.0
≥ 200 (or leave FREQ pin open)	2.2 ¹⁶⁾
68	2.4
100	2.6
150	2.8

5.1.1 Synchronization input

In PWM mode the device can synchronize the switching frequency to an external oscillator connected to the SYNC pin. The internal clock manager triggers at the falling edge of the external signal. The phase shift towards the switching frequency can be adjusted with the duty cycle of the external oscillator. 50% duty cycle of the external oscillator corresponds to a phase shift of approximately zero. A suitable setting of R_{FREQ} is required so that the internal operation frequency is equal to the corresponding external synchronization frequency or above it. This is a prerequisite for the automatic transitions between PWM mode and PFM mode.

As soon as the startup is completed and the device accepts the external signal at the SYNC pin, the synchronization turns active.

¹³ Resistor tolerance ≤ 5%.

¹⁴ Default oscillator low frequency.

¹⁵ Resistor tolerance ≤ 5%.

¹⁶ Default oscillator high frequency.

Oscillator

5.1.2 Spread spectrum

In PWM mode, when used without an external clock at the SYNC pin, the TLS4120D0EPV can apply spread spectrum to optimize EMI performance. The device modulates the switching frequency up and down by a triangle waveform with a typical frequency of 8.3 kHz within a range of typically $\pm 7.5\%$ of the selected oscillator frequency. The logical signal on the SSON pin switches spread spectrum on or off.

5.2 Electrical characteristics oscillator

Table 7 Electrical characteristics oscillator

$V_{VS} = 6\text{ V to }35\text{ V}$; $T_j = -40^\circ\text{C to }150^\circ\text{C}$; all voltages with respect to ground (unless otherwise specified)

Parameter	Symbol	Values			Unit	Note or condition	Number
		Min.	Typ.	Max.			
Frequency setting							
Default oscillator low frequency	$f_{osc,1}$	396	440	484	kHz	$R_{FREQ} \leq 1.0\text{ k}\Omega$ or connect FREQ pin directly to GND	P_5.2.1
Default oscillator high frequency	$f_{osc,2}$	1.98	2.2	2.42	MHz	$R_{FREQ} \geq 200\text{ k}\Omega$ or leave FREQ pin open	P_5.2.2
Oscillator frequency	$f_{osc,3}$	288	320	352	kHz	$R_{FREQ} = 2.2\text{ k}\Omega$	P_5.2.3
Oscillator frequency	$f_{osc,4}$	324	360	396	kHz	$R_{FREQ} = 3.3\text{ k}\Omega$	P_5.2.4
Oscillator frequency	$f_{osc,5}$	360	400	440	kHz	$R_{FREQ} = 4.7\text{ k}\Omega$	P_5.2.5
Oscillator frequency	$f_{osc,6}$	432	480	528	kHz	$R_{FREQ} = 6.8\text{ k}\Omega$	P_5.2.6
Oscillator frequency	$f_{osc,7}$	468	520	572	kHz	$R_{FREQ} = 10\text{ k}\Omega$	P_5.2.7
Oscillator frequency	$f_{osc,8}$	504	560	616	kHz	$R_{FREQ} = 15\text{ k}\Omega$	P_5.2.8
Oscillator frequency	$f_{osc,9}$	1.44	1.6	1.76	MHz	$R_{FREQ} = 22\text{ k}\Omega$	P_5.2.9
Oscillator frequency	$f_{osc,10}$	1.62	1.8	1.98	MHz	$R_{FREQ} = 33\text{ k}\Omega$	P_5.2.10
Oscillator frequency	$f_{osc,11}$	1.8	2.0	2.2	MHz	$R_{FREQ} = 47\text{ k}\Omega$	P_5.2.11
Oscillator frequency	$f_{osc,12}$	2.16	2.4	2.64	MHz	$R_{FREQ} = 68\text{ k}\Omega$	P_5.2.12
Oscillator frequency	$f_{osc,13}$	2.34	2.6	2.86	MHz	$R_{FREQ} = 100\text{ k}\Omega$	P_5.2.13
Oscillator frequency	$f_{osc,14}$	2.52	2.8	3.08	MHz	$R_{FREQ} = 150\text{ k}\Omega$	P_5.2.14

Synchronization input

Synchronization low frequency capture range	$f_{sync,lf}$	320	–	560	kHz	¹⁷⁾ valid for oscillator low frequency range	P_5.2.15
Synchronization high frequency capture range	$f_{sync,hf}$	1.6	–	2.8	MHz	¹⁷⁾ valid for oscillator high frequency range	P_5.2.16
SYNC "high" signal	$V_{SYNC,hi}$	3.0	–	–	V	¹⁷⁾ $5.5\text{ V} \leq V_{VS} \leq 35\text{ V}$	P_5.2.17

¹⁷⁾ Synchronization of PWM to the falling edge.

Oscillator

Table 7 Electrical characteristics oscillator (continued)

$V_{\text{S}} = 6 \text{ V to } 35 \text{ V}$; $T_{\text{j}} = -40^{\circ}\text{C to } 150^{\circ}\text{C}$; all voltages with respect to ground (unless otherwise specified)

Parameter	Symbol	Values			Unit	Note or condition	Number
		Min.	Typ.	Max.			
SYNC "low" signal	$V_{\text{SYNC,lo}}$	–	–	0.8	V	¹⁷⁾	P_5.2.21
SYNC signal hysteresis	$V_{\text{SYNC,hys}}$	45	255	600	mV	¹⁷⁾	P_5.2.22
SYNC "high" input current	$I_{\text{SYNC,hi}}$	–	0.1	1	μA	$V_{\text{SYNC}} = 5 \text{ V}$	P_5.2.25
SYNC "low" input current	$I_{\text{SYNC,lo}}$	–	0.1	1	μA	$V_{\text{SYNC}} = 0 \text{ V}$	P_5.2.26
SYNC signal duty cycle	D_{SYNC}	10	–	90	%	–	P_5.2.28

Spread spectrum

Spread spectrum "high" signal	$V_{\text{SSON,hi}}$	2.0	–	–	V	Enables spread spectrum	P_5.2.29
Spread spectrum "low" signal	$V_{\text{SSON,lo}}$	–	–	0.8	V	Disables spread spectrum	P_5.2.30
Spread spectrum enable hysteresis	$V_{\text{SSON,hys}}$	100	250	1000	mV	–	P_5.2.31
Spread spectrum enable "high" input current	$I_{\text{SSON,hi}}$	0.7	1	1.25	μA	$V_{\text{SSON}} = 5.0 \text{ V}$	P_5.2.32
Spread spectrum modulation frequency	$f_{\text{SS,mod}}$	7.5	8.3	9.3	kHz	Spread spectrum enabled	P_5.2.33
Spread spectrum modulation range	$f_{\text{SS,range}}$	–	± 7.5	–	%	Spread spectrum enabled	P_5.2.34

¹⁷⁾ Synchronization of PWM to the falling edge.

Oscillator

5.3 Typical performance characteristics oscillator

Oscillator (low frequency)

$V_{VS} = 13.5\text{ V}$; FREQ: 440 kHz

Oscillator (high frequency)

$V_{VS} = 13.5\text{ V}$; FREQ: 2.2 MHz

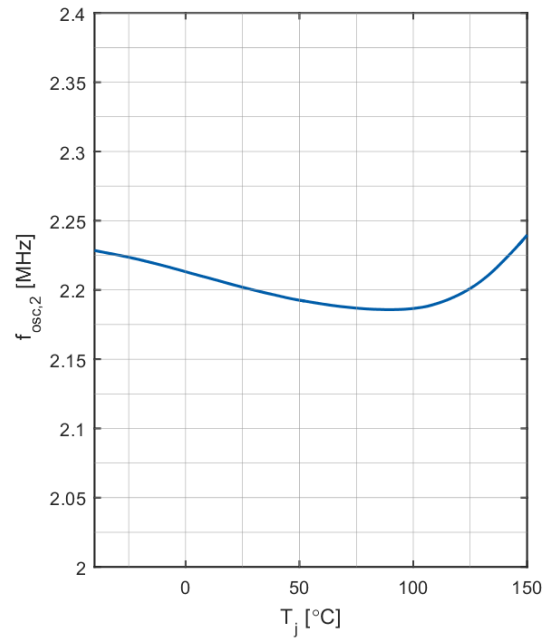
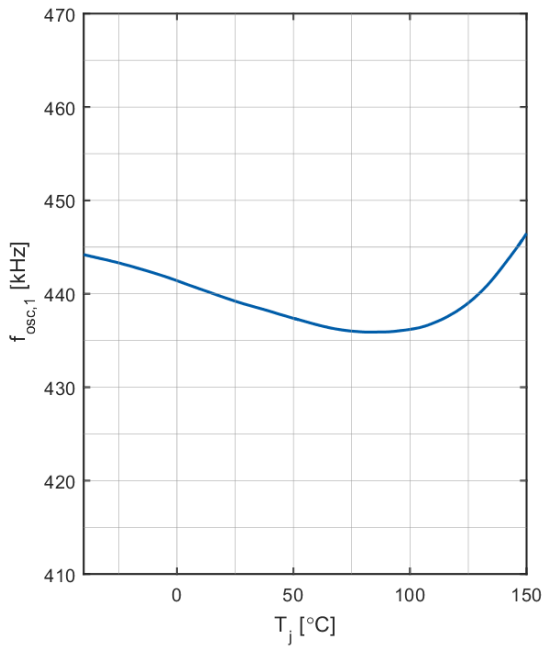

Current consumption and enable

6 Current consumption and enable

6.1 Functional description current consumption and enable

A "high" signal $V_{EN,hi}$ at the EN pin switches on the regulator. In on-state the device can operate at very low current consumption $I_{VS,on}$ to improve the efficiency with low load in PFM mode.

A "low" signal $V_{EN,lo}$ at the EN pin switches the regulator off. In turned off-state, the current consumption $I_{VS,off}$ of the device is 1 μ A typically. If the EN pin is left open, then an internal pull-down resistor $R_{EN,int}$ ensures that the device remains switched off.

6.2 Electrical characteristics current consumption and enable

Table 8 Electrical characteristics current consumption and enable

$V_{VS} = 6\text{ V to }35\text{ V}$; $T_j = -40^\circ\text{C to }150^\circ\text{C}$; all voltages with respect to ground (unless otherwise specified)

Parameter	Symbol	Values			Unit	Note or condition	Number
		Min.	Typ.	Max.			
Current consumption							
Current consumption in off-state	$I_{VS,off}$	–	1	2	μ A	$V_{EN} = 0\text{ V}$; $V_{VS} = 13.5\text{ V}$; $T_j < 85^\circ\text{C}$	P_6.2.1
Current consumption in on-state	$I_{VS,on}$	–	31	65	μ A	$V_{EN} = 5.0\text{ V}$; $V_{VS} = 13.5\text{ V}$; $T_j < 85^\circ\text{C}$; not switching ¹⁸⁾	P_6.2.2
Enable							
Enable "high" signal	$V_{EN,hi}$	2.0	–	–	V	–	P_6.2.3
Enable "low" signal	$V_{EN,lo}$	–	–	0.8	V	–	P_6.2.4
Enable hysteresis	$V_{EN,hys}$	100	400	1000	mV	–	P_6.2.5
Enable "high" input current	$I_{EN,hi,1}$	–	0.6	1	μ A	$V_{EN} = 5.0\text{ V}$	P_6.2.6
Enable "high" input current	$I_{EN,hi,2}$	–	2.5	3.5	μ A	$V_{EN} = 13.5\text{ V}$	P_6.2.7
Enable, internal resistor to GND	$R_{EN,int}$	5.6	8	10.4	M Ω	$V_{EN} = 2.0\text{ V}$	P_6.2.8

¹⁸ The current consumption is tested while the output voltage is forced to a slightly higher value than the nominal output voltage to prevent switching activities of the regulator.

Current consumption and enable

6.3 Typical performance characteristics current consumption and enable

Current consumption in off-state

$V_{VS} = 13.5\text{ V}; V_{EN} = 0\text{ V}$

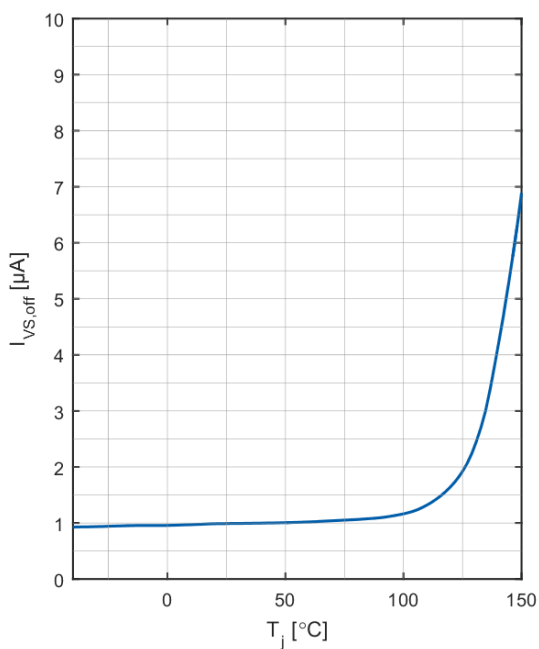

Current consumption in on-state

$V_{VS} = 13.5\text{ V}; V_{EN} = 5\text{ V};$ no switching

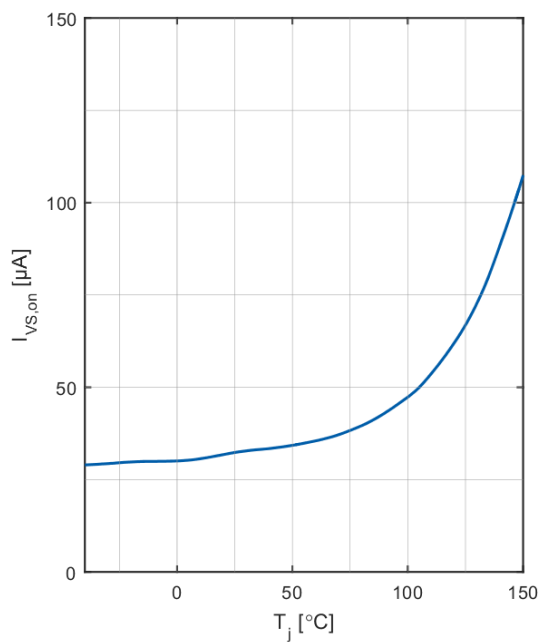

Enable "high" input current

$V_{VS} = 13.5\text{ V}$

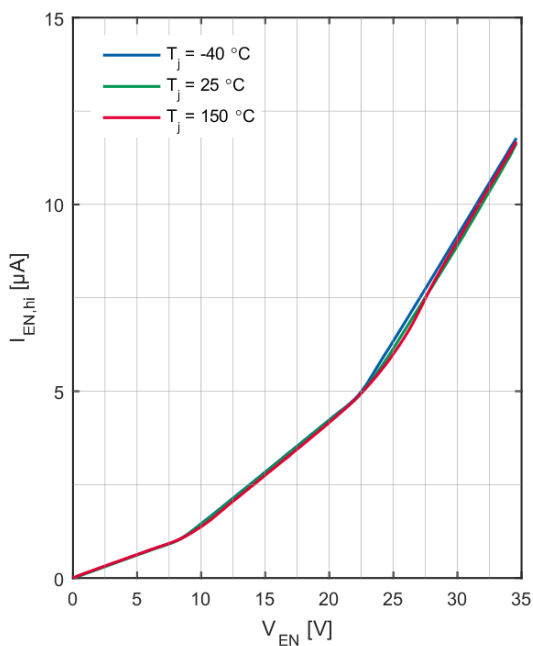

Reset

7 Reset

7.1 Functional description reset

The reset function supervises the regulator output voltage V_{CC} by monitoring the feedback voltage V_{FB} . The device indicates the reset status at the RO pin. RO "high" indicates, that the output voltage is within the desired reset thresholds. RO "low" indicates that the output voltage is outside the desired reset thresholds. As long as the device operates within the specified range, the reset function is active, see [Table 10](#) and [Functional range](#).

Reset output RO

The reset output pin RO is an open drain structure and needs to be pulled up to V_{CC} or to a voltage rail via an external pull-up resistor R_{RO} , which must be chosen according to the maximum pull-up current $I_{RO,IO}$. During battery cranking conditions of the input voltage V_{VS} , the reset feature is active down to an input voltage V_{VS} of 2.8 V.

Power-on reset delay time

Power-on reset delay time $t_{RD,PWR-on}$ is the time period from completion of the soft-start until the device releases the reset by switching the reset output RO from "low" to "high", see [Figure 8](#). An external resistor R_{RT} connected to the RT pin determines the value of power-on reset delay time $t_{RD,PWR-on}$, see [Table 9](#).

Reset undervoltage, overvoltage and delay time

In contrast to the power-on reset delay time $t_{RD,PWR-on}$, the reset delay time t_{RD} refers to an output undervoltage or output overvoltage event during operation, see [Figure 8](#). If V_{FB} drops below the undervoltage reset threshold $V_{RT,UV,th}$, then the device sets the reset signal at the RO to "low". When the output voltage recovers and V_{FB} exceeds the undervoltage reset threshold plus the hysteresis ($V_{RT,UV,th} + V_{RT,UV,hys}$), then the device sets the RO pin to "high" after the reset delay time t_{RD} . In accordance with the undervoltage reset delay time, the overvoltage reset delay time t_{RD} considers an output overvoltage event. If case V_{FB} exceeds the overvoltage reset threshold $V_{RT,OV,th}$, then the device sets the RO pin to "low". When the output voltage recovers and V_{FB} drops below the overvoltage reset threshold minus the hysteresis ($V_{RT,OV,th} - V_{RT,OV,hys}$), then the device sets the RO pin to "high" after the reset delay time t_{RD} . An external resistor R_{RT} connected to the RT pin determines the value of the reset delay time t_{RD} along with the reset undervoltage threshold $V_{RT,UV,th}$, see [Table 9](#). The device sets the selected reset delay time and reset threshold during initialization phase. The value of the overvoltage reset threshold $V_{RT,OV,th}$ is fixed.

Reset reaction time

If the output voltage of the regulator drops below the output undervoltage reset threshold $V_{RT,UV,th}$ or rises above the output overvoltage reset threshold $V_{RT,OV,th}$, then this triggers the internal output voltage monitoring circuit. If that condition lasts longer than the blanking time $t_{r,blank}$ (see [Table 10](#)), then the device sets the reset signal at the RO pin to "low". If the output overvoltage or undervoltage condition lasts shorter than $t_{r,blank}$, then the device keeps the reset signal "high". This prevents a microcontroller reset due to very short distortions of the output voltage, see [Figure 8](#).

Reset

Table 9 RT configuration for typical values of power-on, undervoltage, overvoltage reset delay time and undervoltage reset threshold

R_{RT} [k Ω] ¹⁹⁾	$t_{RD,PWR-on}$ [ms]	t_{RD} [ms]	$V_{RT,UV,th}$ [% of V_{FB}] ²⁰⁾
≤ 1.0 (or connect to GND)	0.06	0.03	-8
2.2	0.06	0.03	-14
3.3	0.06	0.03	-25
4.7	0.06	0.03	-40
6.8	1.9	1.3	-8
10	1.9	1.3	-14
15	1.9	1.3	-25
22	1.9	1.3	-40
33	7.7	5.1	-14
47	7.7	5.1	-25
68	7.7	5.1	-40
100	15.4	10.2	-8
150	15.4	10.2	-14
≥ 200 (or leave open)	7.7	5.1	-8

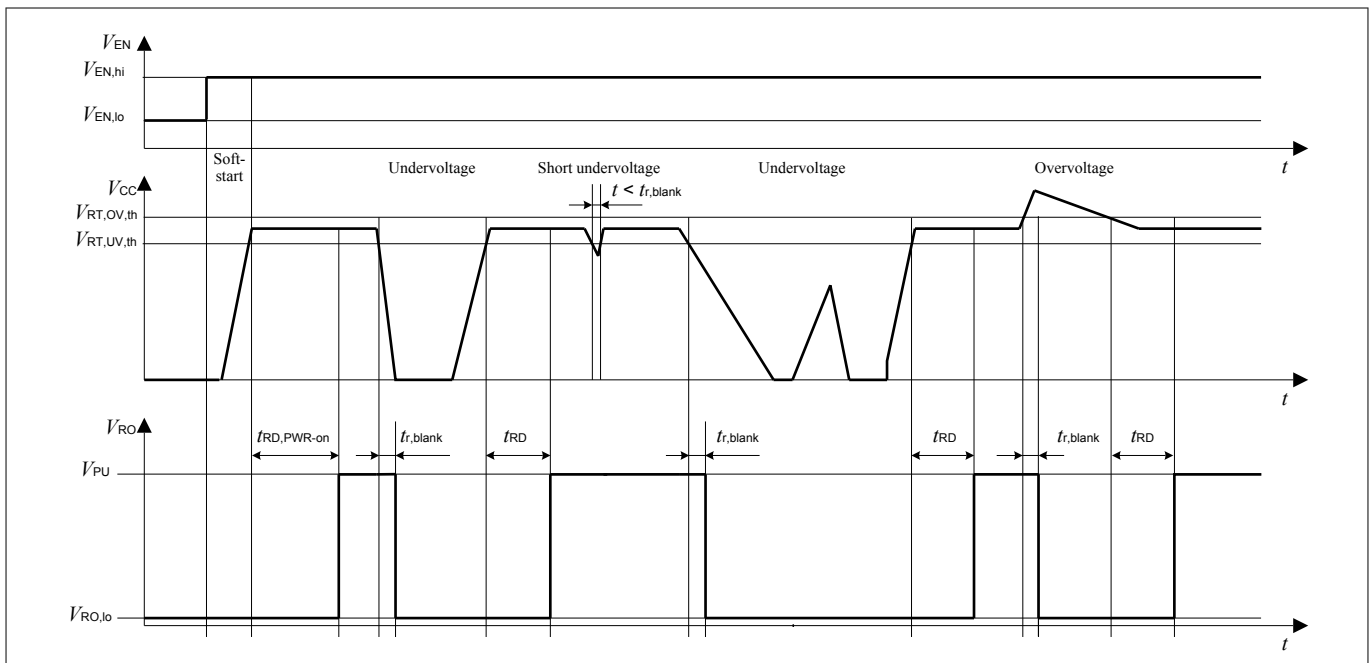

Figure 8 Reset timing diagram²¹⁾

¹⁹ Resistor tolerance ≤ 5%.

²⁰ In relation to the typical feedback voltage level 0.8 V.

²¹ The diagram neglects the reset undervoltage hysteresis and reset overvoltage hysteresis to improve the overview. V_{RO} is connected to an external pull-up voltage V_{PU} via an external pull-up resistor. The input voltage V_{VS} is set to a level higher than $V_{VS,on}$.

Reset

7.2 Electrical characteristics reset

Table 10 Electrical characteristics reset

$V_{VS} = 6\text{ V to }35\text{ V}$; $T_j = -40^\circ\text{C to }150^\circ\text{C}$; all voltages with respect to ground (unless otherwise specified)

Parameter	Symbol	Values			Unit	Note or condition	Number
		Min.	Typ.	Max.			
Reset output RO							
Reset output "low" voltage	$V_{RO,lo}$	–	–	0.4	V	$V_{EN} \geq 2\text{ V}$; $I_{RO} \leq 1.5\text{ mA}$	P_7.2.1
Reset output "low" pull-up current	$I_{RO,lo}$	–	–	1.5	mA	$V_{EN} \geq 2\text{ V}$; $V_{RO} = 0.4\text{ V}$	P_7.2.2
Reset output "high" leakage current	$I_{RO,hi}$	–	–	1	μA	$V_{RO} = 5\text{ V}$	P_7.2.3
Output overvoltage reset threshold							
Output overvoltage reset threshold increasing	$V_{RT,OV,th}$	5	7	9	%	percentage of V_{FB}	P_7.2.4
Output overvoltage reset hysteresis	$V_{RT,OV,hys}$	–	1	2	%	percentage of V_{FB}	P_7.2.5
Output undervoltage reset threshold²²⁾							
Output undervoltage reset threshold decreasing -8%	$V_{RT,UV,th,1}$	-10	-8	-6	%	percentage of V_{FB}	P_7.2.6
Output undervoltage reset threshold decreasing -14%	$V_{RT,UV,th,2}$	-16	-14	-12	%	percentage of V_{FB}	P_7.2.7
Output undervoltage reset threshold decreasing -25%	$V_{RT,UV,th,3}$	-27	-25	-23	%	percentage of V_{FB}	P_7.2.8
Output undervoltage reset threshold decreasing -40%	$V_{RT,UV,th,4}$	-42	-40	-38	%	percentage of V_{FB}	P_7.2.9
Output undervoltage reset hysteresis	$V_{RT,UV,hys}$	–	1	2	%	percentage of V_{FB}	P_7.2.10
Reset delay timing²²⁾							
Power-on reset delay time 60 μs	$t_{RD,PWR-on,1}$	15	60	90	μs	–	P_7.2.11
Power-on reset delay time 1.9 ms	$t_{RD,PWR-on,2}$	1.7	1.9	2.2	ms	–	P_7.2.12
Power-on reset delay time 7.7 ms	$t_{RD,PWR-on,3}$	6.9	7.7	8.6	ms	–	P_7.2.13
Power-on reset delay time 15.4 ms	$t_{RD,PWR-on,4}$	13.9	15.4	17.1	ms	–	P_7.2.14
Reset delay time 30 μs	$t_{RD,1}$	15	30	95	μs	–	P_7.2.15

²²⁾ For RT configuration see [Table 9](#)

Reset

Table 10 Electrical characteristics reset (continued)

$V_{\text{S}} = 6 \text{ V to } 35 \text{ V}$; $T_{\text{j}} = -40^{\circ}\text{C to } 150^{\circ}\text{C}$; all voltages with respect to ground (unless otherwise specified)

Parameter	Symbol	Values			Unit	Note or condition	Number
		Min.	Typ.	Max.			
Reset delay time 1.3 ms	$t_{\text{RD},2}$	1.1	1.3	1.5	ms	–	P_7.2.16
Reset delay time 5.1 ms	$t_{\text{RD},3}$	4.6	5.1	5.7	ms	–	P_7.2.17
Reset delay time 10.2 ms	$t_{\text{RD},4}$	9.3	10.2	11.4	ms	–	P_7.2.18
Reset blanking time	$t_{\text{r,blank}}$	2	5	10	μs	–	P_7.2.19

Reset

7.3 Typical performance characteristics reset

Output undervoltage reset threshold

$V_{VS} = 13.5 \text{ V}$

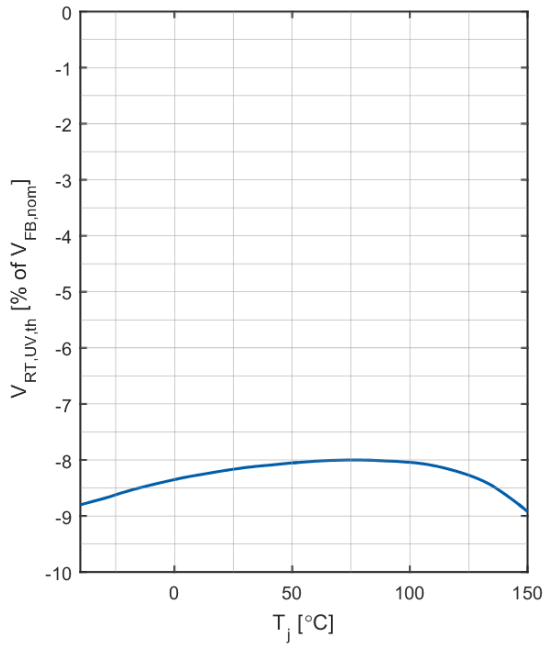

Output overvoltage reset threshold

$V_{VS} = 13.5 \text{ V}$

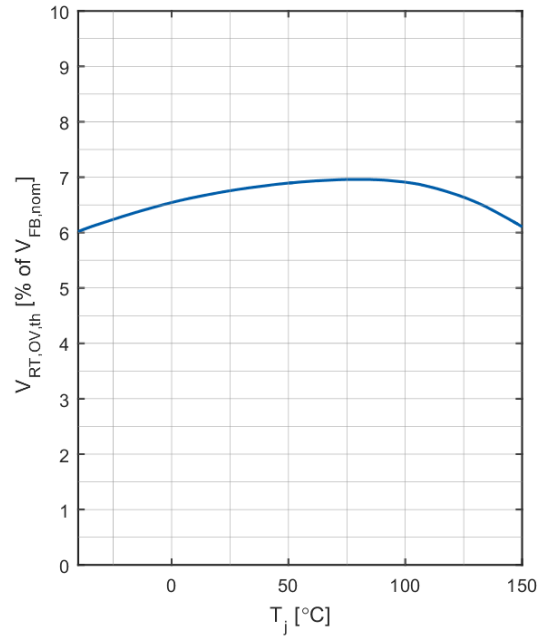

Application information

8 Application information

Note: The following information is given as an example for the implementation of the device only and shall not be regarded as a description or warranty of a certain functionality, condition or quality of the device.

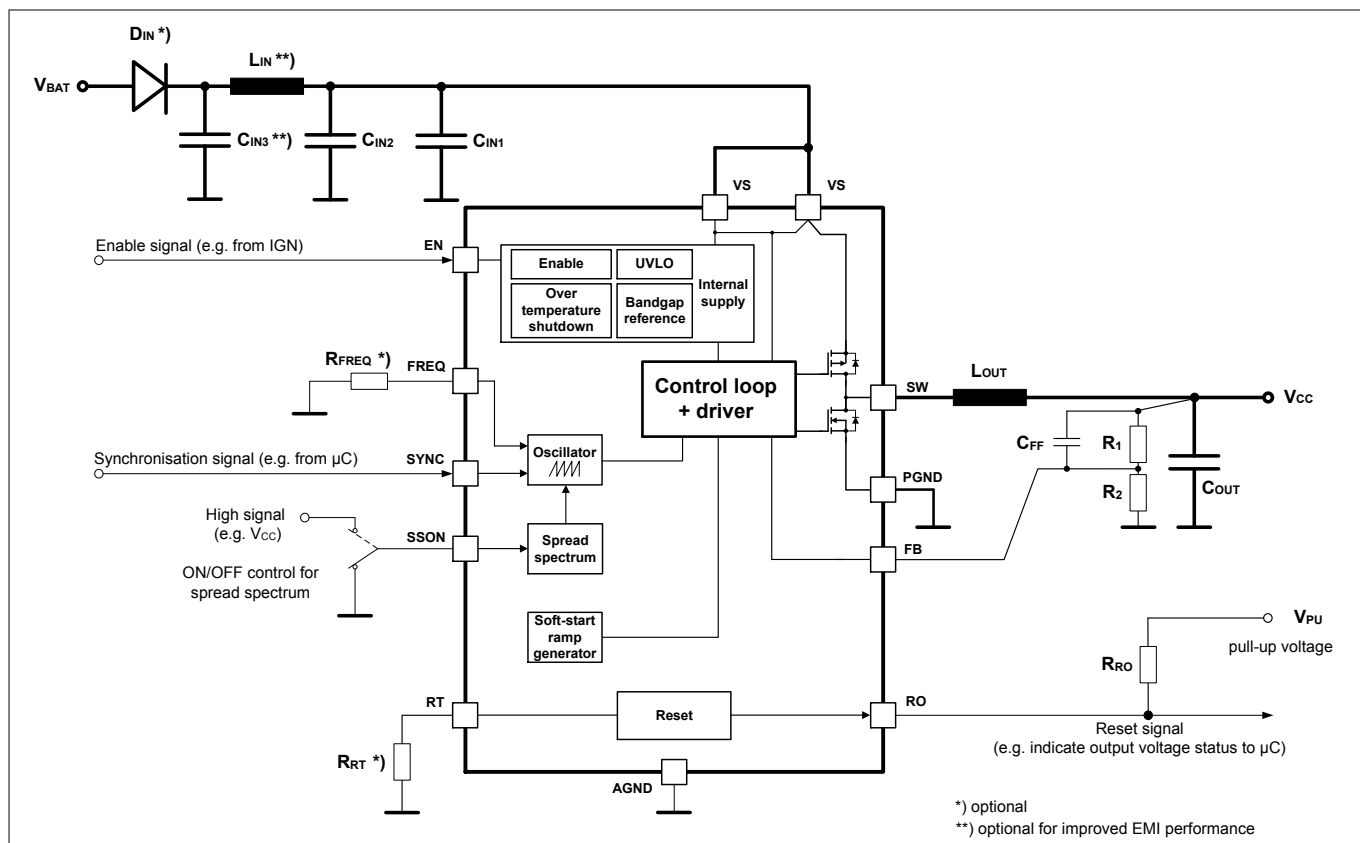

Figure 9 Application diagram

Note: This figure is a simplified example of an application circuit. The function must be verified in the application.

Application information

Table 11 Recommended values for components in the application diagram

Name	Value ²³⁾	Switching frequency range	Output voltage range	Component type
C _{IN1}	100 nF	–	–	Ceramic X7R capacitor; 50 V
C _{IN2}	10 μF	–	–	Ceramic X7R capacitor; 50 V
L _{OUT}	22 μH	320 kHz to 560 kHz	–	Shielded power inductor; I _{SAT} > I _{BUOC} DCR < 70 mΩ
C _{OUT}	88 μF ²⁴⁾	320 kHz to 560 kHz	–	22 μF (x4) ceramic X7R capacitor; 16 V
L _{OUT}	2.2 μH	1.6 MHz to 2.8 MHz	3 V ≤ V _{CC} ≤ 5 V	Shielded power inductor; I _{SAT} > I _{BUOC} DCR < 70 mΩ
C _{OUT}	44 μF ²⁴⁾	1.6 MHz to 2.8 MHz	3 V ≤ V _{CC} ≤ 5 V	22 μF (x2) ceramic X7R capacitor; 16 V
L _{OUT}	4.7 μH	1.6 MHz to 2.8 MHz	5 V < V _{CC} ≤ 10 V	Shielded power inductor; I _{SAT} > I _{BUOC} DCR < 70 mΩ
C _{OUT}	22 μF ²⁴⁾	1.6 MHz to 2.8 MHz	5 V < V _{CC} ≤ 10 V	22 μF ceramic X7R capacitor; 25 V

8.1 Output voltage adjustment

The output voltage of the TLS4120D0EPV can be adjusted with an external voltage divider connected to the FB pin. To achieve a high output voltage accuracy, a resistor R₂ < 160 kΩ is recommended. By neglecting the current flowing into the FB pin, the desired resistance R₁ can be calculated depending on the required nominal output voltage V_{CC}:

$$R_1 = R_2 \left(\frac{V_{CC}}{V_{FB}} - 1 \right)$$

Equation 1

8.2 Feedforward capacitor

An additional feedforward capacitor C_{FF} between the output voltage node V_{CC} and the feedback pin FB might be required for stable operation (see [Figure 9](#)). A good starting value is a feedforward capacitor of 10 pF, but the best value may be higher due to additional parasitic capacitance at the FB pin to GND resulting from the PCB layout. The capacitance must match the conditions of the application.

²³ Typical condition

²⁴ For maintenance of loop stability it is recommended to use capacitors with a limited voltage derating at the typical output voltage level. A capacitor in parallel can be added to match the recommended typical capacitance value as close as possible.

Application information

8.3 Layout recommendations

Introduction

A switch mode power supply is a potential source of electromagnetic disturbance, which may affect the application environment as well as the device itself. This can lead to sporadic malfunction including regulator instability or irreversible damage depending on the amount of generated disturbance.

Main types of electromagnetic disturbance:

- Radiated emission
- Conducted emission

Radiated emission

Radiated emission is caused by circulating currents and voltage oscillations. Alternating currents appear in so called current windows, which are defined by the area of the circulating current within the corresponding filter stage at the input or the output of the regulator. Voltage oscillations are mainly caused by resonant circuits induced by parasitic inductance and capacitance of the PCB layout.

The following PCB layout design recommendations help to minimize radiated emission:

- Place external components close to the device to reduce parasitic elements of the PCB layout and to keep the area of circulating currents small. At the same time some distance should be kept between the components to avoid coupling.
- Reduce the switching area at pin SW to minimize the inductance and especially the parasitic capacitance. The parasitic capacitance can be further reduced by removing inner GND layers below the switching area. Routing of other signal traces below the switching area should be avoided generally.
- Use GND layers to shield areas with alternating currents or voltage oscillations.

Conducted emission

Conducted emission consists of voltage oscillations, which occur permanently or by occasion at the regulator input or output connection. Their frequency range can exceed 100 MHz and they are superimposed to the input voltage V_{VS} and to the output voltage V_{CC} . This might disturb other components of the application.

Countermeasures against conducted disturbances are the same as against radiated emission. The following recommendations can further reduce the conducted emission:

- Reduce high frequency conducted emission by placing well connected small ceramic filter capacitors (1 nF to 220 nF) with low ESR and low ESL in parallel to the input capacitors as close as possible to the input pin VS and in parallel to the output capacitor C_{OUT} close to the output inductor L_{OUT} .
- Reduce noise injected into the battery supply line by using a π -filter, for example consisting of C_{IN1} , C_{IN2} , C_{IN3} and L_{IN} . This requires additional capacitors and an inductor. The filter must be designed according to the requirements of the application.

8.4 Additional information

Please contact Infineon:

- for information regarding the pin behavioral assessment
- for application notes with more detailed information about this device
- for any further information visit <https://www.infineon.com/>

Package information

9 Package information

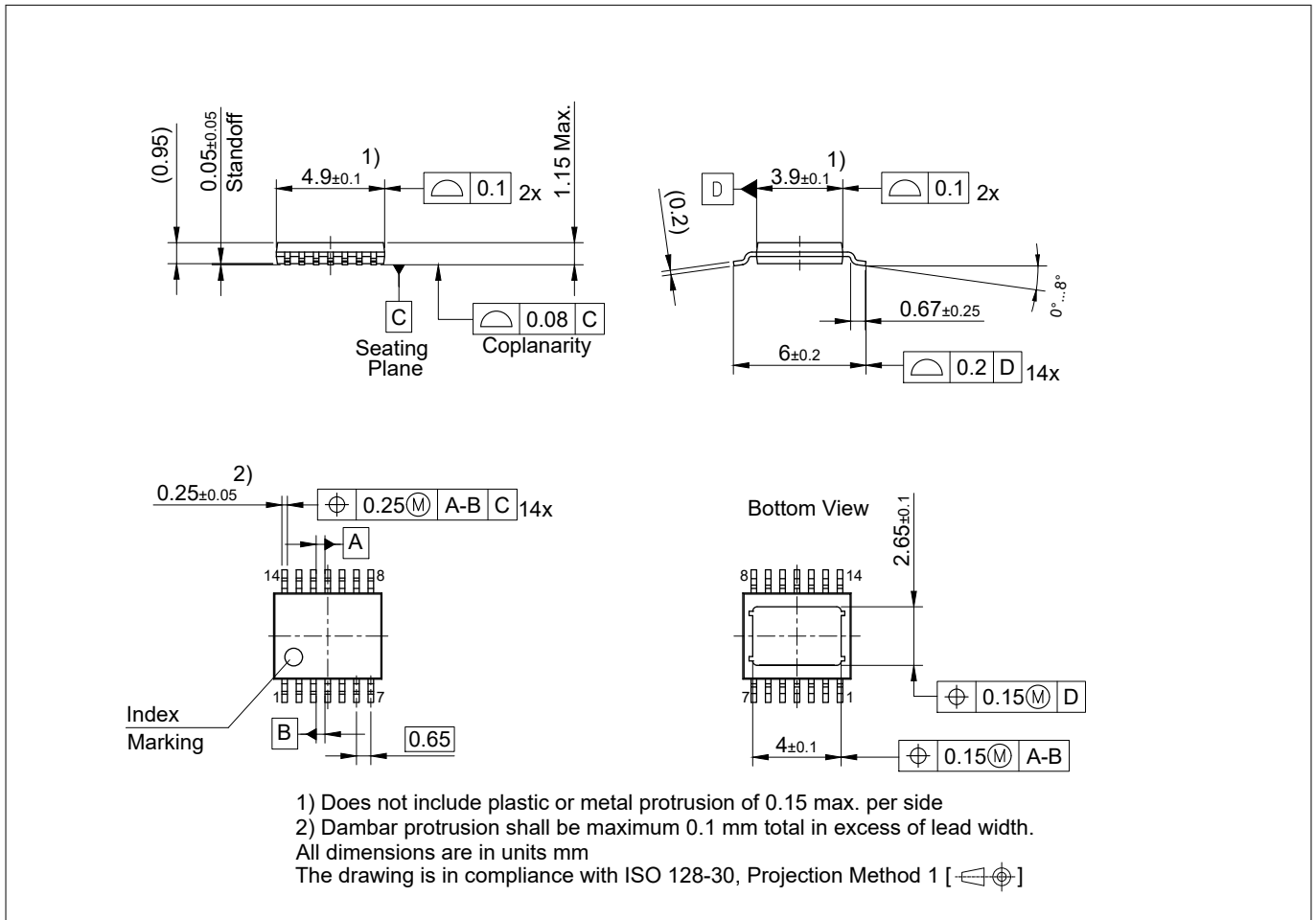

Figure 10 PG-TSDSO-14

Green Product (RoHS compliant)

To meet the world-wide customer requirements for environmentally friendly products and to be compliant with government regulations the device is available as a Green Product. Green Products are RoHS compliant (Pb-free finish on leads and suitable for Pb-free soldering according to IPC/JEDEC J-STD-020).

Information on alternative packages

Please visit www.infineon.com/packages.

Revision history

Revision history

Version	Date	Changes
Rev. 1.02	2021-02-05	Editorial changes
Rev. 1.01	2020-10-15	Editorial changes
Rev. 1.0	2020-03-20	Initial datasheet

Trademarks

All referenced product or service names and trademarks are the property of their respective owners.

Edition 2021-02-05

Published by
Infineon Technologies AG
81726 Munich, Germany

© 2021 Infineon Technologies AG
All Rights Reserved.

Do you have a question about any
aspect of this document?
Email: erratum@infineon.com

Document reference
IFX-Z8F63766653

IMPORTANT NOTICE

The information given in this document shall in no event be regarded as a guarantee of conditions or characteristics ("Beschaffenhheitsgarantie").

With respect to any examples, hints or any typical values stated herein and/or any information regarding the application of the product, Infineon Technologies hereby disclaims any and all warranties and liabilities of any kind, including without limitation warranties of non-infringement of intellectual property rights of any third party.

In addition, any information given in this document is subject to customer's compliance with its obligations stated in this document and any applicable legal requirements, norms and standards concerning customer's products and any use of the product of Infineon Technologies in customer's applications.

The data contained in this document is exclusively intended for technically trained staff. It is the responsibility of customer's technical departments to evaluate the suitability of the product for the intended application and the completeness of the product information given in this document with respect to such application.

WARNINGS

Due to technical requirements products may contain dangerous substances. For information on the types in question please contact your nearest Infineon Technologies office.

Except as otherwise explicitly approved by Infineon Technologies in a written document signed by authorized representatives of Infineon Technologies, Infineon Technologies' products may not be used in any applications where a failure of the product or any consequences of the use thereof can reasonably be expected to result in personal injury.