

MC10EL57, MC100EL57

5 V ECL 4:1 Differential Multiplexer

Description

The MC10/100EL57 is a fully differential 4:1 multiplexer. By leaving the SEL1 line open (pulled LOW via the input pull-down resistors) the device can also be used as a differential 2:1 multiplexer with SEL0 input selecting between D0 and D1.

The SEL1 is the most significant select line. The binary number applied to the select inputs will select the same numbered data input (i.e., 00 selects D0).

Multiple V_{BB} outputs are provided for single-ended or AC coupled interfaces. The V_{BB} pin, an internally generated voltage supply, is available to this device only. For single-ended input conditions, the unused differential input is connected to V_{BB} as a switching reference voltage. V_{BB} may also rebias AC coupled inputs. When used, decouple V_{BB} and V_{CC} via a 0.01 μF capacitor and limit current sourcing or sinking to 0.5 mA. When not used, V_{BB} should be left open.

The 100 Series contains temperature compensation.

Features

- Useful as Either 4:1 or 2:1 Multiplexer
- V_{BB} Output for Single-Ended Operation
- PECL Mode Operating Range: $V_{CC} = 4.2\text{ V to }5.7\text{ V}$ with $V_{EE} = 0\text{ V}$
- NECL Mode Operating Range: $V_{CC} = 0\text{ V}$ with $V_{EE} = -4.2\text{ V to }-5.7\text{ V}$
- Internal Input Pull-down Resistors on All Inputs
- Q Outputs Will Default LOW with Inputs Open or at V_{EE}
- These Devices are Pb-Free, Halogen Free and are RoHS Compliant



ON Semiconductor®

www.onsemi.com

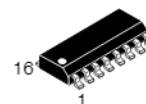

SOIC-16
D SUFFIX
CASE 751B-05

MARKING DIAGRAMS*

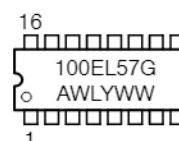
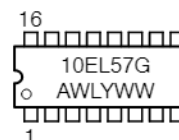

A = Assembly Location
WL = Wafer Lot
YY = Year
WW = Work Week
G = Pb-Free Package

*For additional marking information, refer to Application Note [AND8002/D](#).

ORDERING INFORMATION

Device	Package	Shipping†
MC10EL57DG	SOIC-16 NB (Pb-Free)	48 Units/Tube
MC10EL57DR2G	SOIC-16 NB (Pb-Free)	2500 Tape & Reel
MC100EL57DG	SOIC-16 NB (Pb-Free)	48 Units/Tube
MC100EL57DR2G	SOIC-16 NB (Pb-Free)	2500 Tape & Reel

†For information on tape and reel specifications, including part orientation and tape sizes, please refer to our Tape and Reel Packaging Specifications Brochure, [BRD8011/D](#).

MC10EL57, MC100EL57

Table 1. ATTRIBUTES

Characteristics	Value
Internal Input Pulldown Resistor	75 K Ω
Internal Input Pullup Resistor	N/A
ESD Protection Human Body Model Machine Model Charge Device Model	> 1 kV > 100 V > 2 kV
Moisture Sensitivity (Note 1)	Level 1
Flammability Rating Oxygen Index: 28 to 34	UL 94 V-0 @ 0.125 in
Transistor Count	109 Devices
Meets or Exceeds JEDEC Spec EIA/JESD78 IC Latchup Test	

1. For additional Moisture Sensitivity information, refer to Application Note [AND8003/D](#).

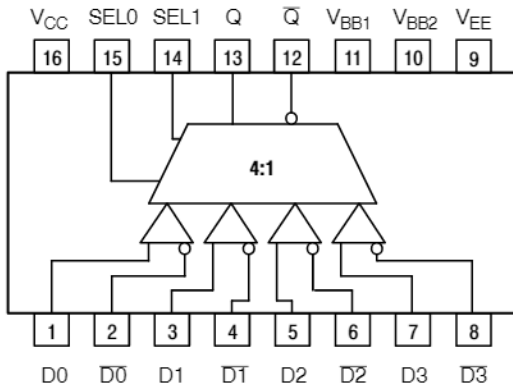

Table 3. FUNCTION TABLE

SEL1*	SEL0*	DATA OUT
L	L	D0
L	H	D1
H	L	D2
H	H	D3

* Pin will default low when left open.

Figure 1. Logic Diagram and Pinout Assignment

Table 2. PIN DESCRIPTION

PIN	FUNCTION
D0-3, $\bar{D}0-3$	ECL Diff Data Inputs
SEL0,1	ECL MUX Select Inputs
Q, \bar{Q}	ECL Data Outputs
VBB1, VBB2	Reference Voltage Output
VCC	Positive Supply
VEE	Negative Supply

MC10EL57, MC100EL57

Table 4. MAXIMUM RATINGS

Symbol	Parameter	Condition 1	Condition 2	Rating	Unit
V _{CC}	PECL Mode Power Supply	V _{EE} = 0 V		8	V
V _{EE}	NECL Mode Power Supply	V _{CC} = 0 V		-8	V
V _I	PECL Mode Input Voltage NECL Mode Input Voltage	V _{EE} = 0 V V _{CC} = 0 V	V _I ≤ V _{CC} V _I ≥ V _{EE}	6 -6	V
I _{out}	Output Current	Continuous Surge		50 100	mA
I _{BB}	V _{BB} Sink/Source			±0.5	mA
T _A	Operating Temperature Range			-40 to +85	°C
T _{stg}	Storage Temperature Range			-65 to +150	°C
θ _{JA}	Thermal Resistance (Junction-to-Ambient)	0 lfpm 500 lfpm	SOIC-16 SOIC-16	130 75	°C/W
θ _{JC}	Thermal Resistance (Junction-to-Case)	Standard Board	SOIC-16	33 to 36	°C/W
T _{sol}	Wave Solder (Pb-Free)	< 2 to 3 sec @ 260°C		265	°C

Stresses exceeding those listed in the Maximum Ratings table may damage the device. If any of these limits are exceeded, device functionality should not be assumed, damage may occur and reliability may be affected.

Table 5. 10EL SERIES PECL DC CHARACTERISTICS (V_{CC} = 5.0 V; V_{EE} = 0 V (Note 1))

Symbol	Characteristic	-40°C			25°C			85°C			Unit
		Min	Typ	Max	Min	Typ	Max	Min	Typ	Max	
I _{EE}	Power Supply Current			24			24			24	mA
V _{OH}	Output HIGH Voltage (Note 2)	3920	4010	4110	4020	4105	4190	4090	4185	4280	mV
V _{OL}	Output LOW Voltage (Note 2)	3050	3200	3350	3050	3210	3370	3050	3227	3405	mV
V _{IH}	Input HIGH Voltage (Single-Ended)	3770		4110	3870		4190	3940		4280	mV
V _{IL}	Input LOW Voltage (Single-Ended)	3050		3500	3050		3520	3050		3555	mV
V _{BB}	Output Voltage Reference	3.57		3.7	3.65		3.75	3.69		3.81	V
V _{IHCMR}	Input HIGH Voltage Common Mode Range (Differential Configuration) (Note 3)	2.5		4.6	2.5		4.6	2.5		4.6	V
I _{IH}	Input HIGH Current			150			150			150	μA
I _{IL}	Input LOW Current	0.5			0.5			0.3			μA

NOTE: Device will meet the specifications after thermal equilibrium has been established when mounted in a test socket or printed circuit board with maintained transverse airflow greater than 500 lfpm. Electrical parameters are guaranteed only over the declared operating temperature range. Functional operation of the device exceeding these conditions is not implied. Device specification limit values are applied individually under normal operating conditions and not valid simultaneously.

1. Input and output parameters vary 1:1 with V_{CC}. V_{EE} can vary +0.06 V / -0.5 V.
2. Outputs are terminated through a 50 Ω resistor to V_{CC} - 2.0 V.
3. V_{IHCMR} min varies 1:1 with V_{EE}; V_{IHCMR} max varies 1:1 with V_{CC}. The V_{IHCMR} range is referenced to the most positive side of the differential input signal. Normal operation is obtained if the HIGH level falls within the specified range and the peak-to-peak voltage lies between V_{PPmin} and 1 V.

MC10EL57, MC100EL57

Table 6. 10EL SERIES NECL DC CHARACTERISTICS ($V_{CC} = 0\text{ V}$; $V_{EE} = -5.0\text{ V}$ (Note 1))

Symbol	Characteristic	-40°C			25°C			85°C			Unit
		Min	Typ	Max	Min	Typ	Max	Min	Typ	Max	
I_{EE}	Power Supply Current			24			24			24	mA
V_{OH}	Output HIGH Voltage (Note 2)	-1080	-990	-890	-980	-895	-810	-910	-815	-720	mV
V_{OL}	Output LOW Voltage (Note 2)	-1950	-1800	-1650	-1950	-1790	-1630	-1950	-1773	-1595	mV
V_{IH}	Input HIGH Voltage (Single-Ended)	-1230		-890	-1130		-810	-1060		-720	mV
V_{IL}	Input LOW Voltage (Single-Ended)	-1950		-1500	-1950		-1480	-1950		-1445	mV
V_{BB}	Output Voltage Reference	-1.43		-1.30	-1.35		-1.25	-1.31		-1.19	V
V_{IHCMR}	Input HIGH Voltage Common Mode Range (Differential Configuration) (Note 3)	-2.5		-0.4	-2.5		-0.4	-2.5		-0.4	V
I_{IH}	Input HIGH Current			150			150			150	μA
I_{IL}	Input LOW Current	0.5			0.5			0.3			μA

NOTE: Device will meet the specifications after thermal equilibrium has been established when mounted in a test socket or printed circuit board with maintained transverse airflow greater than 500 lfm. Electrical parameters are guaranteed only over the declared operating temperature range. Functional operation of the device exceeding these conditions is not implied. Device specification limit values are applied individually under normal operating conditions and not valid simultaneously.

1. Input and output parameters vary 1:1 with V_{CC} . V_{EE} can vary +0.06 V / -0.5 V.
2. Outputs are terminated through a 50 Ω resistor to $V_{CC} - 2.0\text{ V}$.
3. V_{IHCMR} min varies 1:1 with V_{EE} , V_{IHCMR} max varies 1:1 with V_{CC} . The V_{IHCMR} range is referenced to the most positive side of the differential input signal. Normal operation is obtained if the HIGH level falls within the specified range and the peak-to-peak voltage lies between V_{ppmin} and 1 V.

Table 7. 100EL SERIES PECL DC CHARACTERISTICS ($V_{CC} = 5.0\text{ V}$; $V_{EE} = 0\text{ V}$ (Note 1))

Symbol	Characteristic	-40°C			25°C			85°C			Unit
		Min	Typ	Max	Min	Typ	Max	Min	Typ	Max	
I_{EE}	Power Supply Current			24			24			27	mA
V_{OH}	Output HIGH Voltage (Note 2)	3915	3995	4120	3975	4045	4120	3975	4050	4120	mV
V_{OL}	Output LOW Voltage (Note 2)	3170	3305	3445	3190	3295	3380	3190	3295	3380	mV
V_{IH}	Input HIGH Voltage (Single-Ended)	3835		4120	3835		4120	3835		4120	mV
V_{IL}	Input LOW Voltage (Single-Ended)	3190		3525	3190		3525	3190		3525	mV
V_{BB}	Output Voltage Reference	3.62		3.74	3.62		3.74	3.62		3.74	V
V_{IHCMR}	Input HIGH Voltage Common Mode Range (Differential Configuration) (Note 3)	2.5		4.6	2.5		4.6	2.5		4.6	V
I_{IH}	Input HIGH Current			150			150			150	μA
I_{IL}	Input LOW Current	0.5			0.5			0.5			μA

NOTE: Device will meet the specifications after thermal equilibrium has been established when mounted in a test socket or printed circuit board with maintained transverse airflow greater than 500 lfm. Electrical parameters are guaranteed only over the declared operating temperature range. Functional operation of the device exceeding these conditions is not implied. Device specification limit values are applied individually under normal operating conditions and not valid simultaneously.

1. Input and output parameters vary 1:1 with V_{CC} . V_{EE} can vary +0.8 V / -0.5 V.
2. Outputs are terminated through a 50 Ω resistor to $V_{CC} - 2.0\text{ V}$.
3. V_{IHCMR} min varies 1:1 with V_{EE} , V_{IHCMR} max varies 1:1 with V_{CC} . The V_{IHCMR} range is referenced to the most positive side of the differential input signal. Normal operation is obtained if the HIGH level falls within the specified range and the peak-to-peak voltage lies between V_{ppmin} and 1 V.

MC10EL57, MC100EL57

Table 8. 100EL SERIES NECL DC CHARACTERISTICS ($V_{CC} = 0\text{ V}$; $V_{EE} = -5.0\text{ V}$ (Note 1))

Symbol	Characteristic	-40°C			25°C			85°C			Unit
		Min	Typ	Max	Min	Typ	Max	Min	Typ	Max	
I_{EE}	Power Supply Current			24			24			27	mA
V_{OH}	Output HIGH Voltage (Note 2)	-1085	-1005	-880	-1025	-955	-880	-1025	-955	-880	mV
V_{OL}	Output LOW Voltage (Note 2)	-1830	-1695	-1555	-1810	-1705	-1620	-1810	-1705	-1620	mV
V_{IH}	Input HIGH Voltage (Single-Ended)	-1165		-880	-1165		-880	-1165		-880	mV
V_{IL}	Input LOW Voltage (Single-Ended)	-1810		-1475	-1810		-1475	-1810		-1475	mV
V_{BB}	Output Voltage Reference	-1.38		-1.26	-1.38		-1.26	-1.38		-1.26	V
V_{IHCMR}	Input HIGH Voltage Common Mode Range (Differential Configuration) (Note 3)	-2.5		-0.4	-2.5		-0.4	-2.5		-0.4	V
I_{IH}	Input HIGH Current			150			150			150	μA
I_{IL}	Input LOW Current	0.5			0.5			0.5			μA

NOTE: Device will meet the specifications after thermal equilibrium has been established when mounted in a test socket or printed circuit board with maintained transverse airflow greater than 500 lpm. Electrical parameters are guaranteed only over the declared operating temperature range. Functional operation of the device exceeding these conditions is not implied. Device specification limit values are applied individually under normal operating conditions and not valid simultaneously.

1. Input and output parameters vary 1:1 with V_{CC} . V_{EE} can vary +0.8 V / -0.5 V.
2. Outputs are terminated through a 50 Ω resistor to $V_{CC} - 2.0\text{ V}$.
3. V_{IHCMR} min varies 1:1 with V_{EE} , V_{IHCMR} max varies 1:1 with V_{CC} . The V_{IHCMR} range is referenced to the most positive side of the differential input signal. Normal operation is obtained if the HIGH level falls within the specified range and the peak-to-peak voltage lies between V_{ppmin} and 1 V.

Table 9. AC CHARACTERISTICS ($V_{CC} = 5.0\text{ V}$; $V_{EE} = 0\text{ V}$ or $V_{CC} = 0\text{ V}$; $V_{EE} = -5.0\text{ V}$ (Note 1))

Symbol	Characteristic	-40°C			25°C			85°C			Unit
		Min	Typ	Max	Min	Typ	Max	Min	Typ	Max	
f_{max}	Maximum Toggle Frequency		TBD			TBD			TBD		GHz
t_{PLH} t_{PHL}	Propagation DATA→Q/ \bar{Q} Delay SEL→Q/ \bar{Q}	350		550	360		560	380		580	ps
t_{SKEW}	Input Skew D_n, D_m to Q			100			100			100	ps
t_{JITTER}	Cycle-to-Cycle Jitter		TBD			TBD			TBD		ps
V_{PP}	Input Swing (Note 2)	150		1000	150		1000	150		1000	mV
t_r t_f	Output Rise/Fall Times Q (20%–80%)	125		375	125		375	125		375	ps

NOTE: Device will meet the specifications after thermal equilibrium has been established when mounted in a test socket or printed circuit board with maintained transverse airflow greater than 500 lpm. Electrical parameters are guaranteed only over the declared operating temperature range. Functional operation of the device exceeding these conditions is not implied. Device specification limit values are applied individually under normal operating conditions and not valid simultaneously.

1. 10 Series: V_{EE} can vary +0.06 V / -0.5 V.
100 Series: V_{EE} can vary +0.8 V / -0.5 V.
2. V_{ppmin} is minimum input swing for which AC parameters guaranteed. The device has a DC gain of ≈ 40 .

MC10EL57, MC100EL57

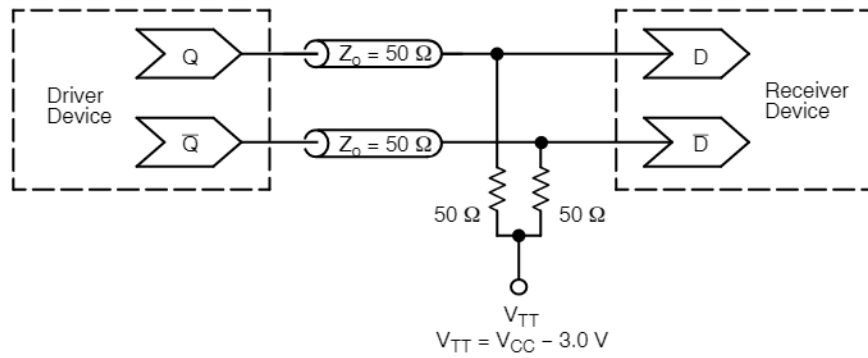

Figure 2. Typical Termination for Output Driver and Device Evaluation
(See Application Note [AND8020/D](#) – Termination of ECL Logic Devices)

Resource Reference of Application Notes

- AN1405/D – ECL Clock Distribution Techniques
- AN1406/D – Designing with PECL (ECL at +5.0 V)
- AN1503/D – ECLinPS™ I/O SPICE Modeling Kit
- AN1504/D – Metastability and the ECLinPS Family
- AN1568/D – Interfacing Between LVDS and ECL
- AN1672/D – The ECL Translator Guide
- AND8001/D – Odd Number Counters Design
- AND8002/D – Marking and Date Codes
- AND8020/D – Termination of ECL Logic Devices
- AND8066/D – Interfacing with ECLinPS
- AND8090/D – AC Characteristics of ECL Devices

MC10EL57, MC100EL57

PACKAGE DIMENSIONS

SOIC-16
D SUFFIX
CASE 751B-05
ISSUE K

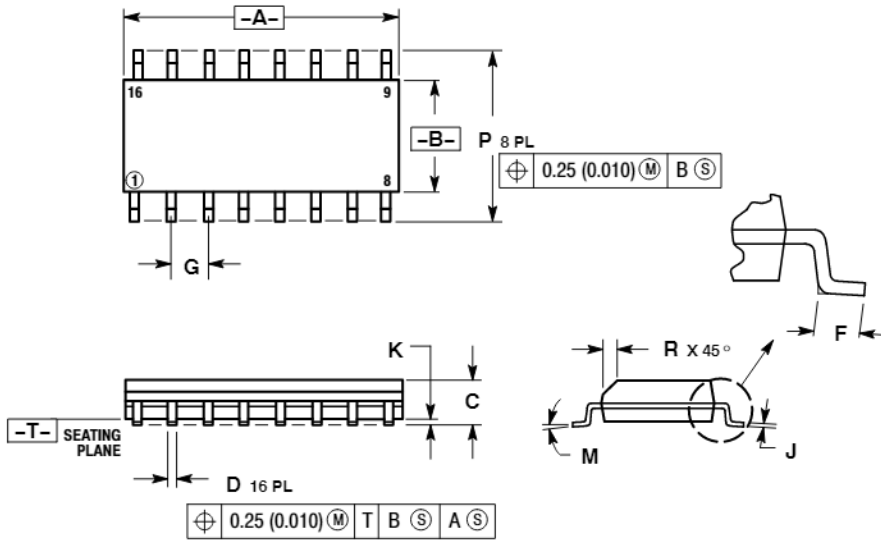

NOTES:

1. DIMENSIONING AND TOLERANCING PER ANSI Y14.5M, 1982.
2. CONTROLLING DIMENSION: MILLIMETER.
3. DIMENSIONS A AND B DO NOT INCLUDE MOLD PROTRUSION.
4. MAXIMUM MOLD PROTRUSION 0.15 (0.006) PER SIDE.
5. DIMENSION D DOES NOT INCLUDE DAMBAR PROTRUSION. ALLOWABLE DAMBAR PROTRUSION SHALL BE 0.127 (0.005) TOTAL IN EXCESS OF THE D DIMENSION AT MAXIMUM MATERIAL CONDITION.

DIM	MILLIMETERS		INCHES	
	MIN	MAX	MIN	MAX
A	9.80	10.00	0.386	0.393
B	3.80	4.00	0.150	0.157
C	1.35	1.75	0.054	0.068
D	0.35	0.49	0.014	0.019
F	0.40	1.25	0.016	0.049
G	1.27 BSC		0.050 BSC	
J	0.19	0.25	0.008	0.009
K	0.10	0.25	0.004	0.009
M	0°	7°	0°	7°
P	5.80	6.20	0.229	0.244
R	0.25	0.50	0.010	0.019

SOLDERING FOOTPRINT

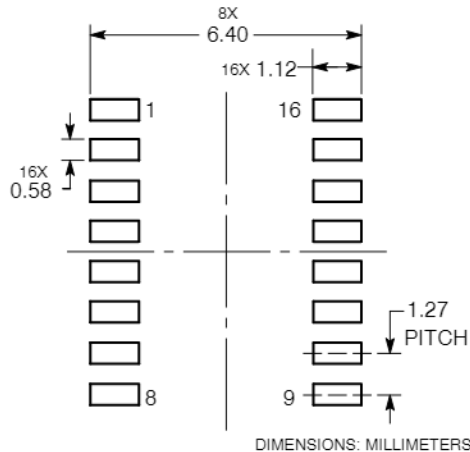

ECLinPS is a trademark of Semiconductor Components Industries, LLC (SCILLC) or its subsidiaries in the United States and/or other countries.

ON Semiconductor and are trademarks of Semiconductor Components Industries, LLC dba ON Semiconductor or its subsidiaries in the United States and/or other countries. ON Semiconductor owns the rights to a number of patents, trademarks, copyrights, trade secrets, and other intellectual property. A listing of ON Semiconductor's product/patent coverage may be accessed at www.onsemi.com/site/pdf/Patent-Marketing.pdf. ON Semiconductor reserves the right to make changes without further notice to its products herein. ON Semiconductor makes no warranty, representation or guarantee regarding the suitability of its products for any particular purpose, nor does ON Semiconductor assume any liability arising out of the application or use of any product or circuit, and specifically disclaims any and all liability, including without limitation special, consequential or incidental damages. Buyer is responsible for its products and applications using ON Semiconductor products, including compliance with all laws, regulations and safety requirements or standards, regardless of any support or applications information provided by ON Semiconductor. "Typical" parameters which may be provided in ON Semiconductor data sheets and/or specifications can and do vary in different applications and actual performance may vary over time. All operating parameters, including "Typicals" must be validated for each customer application by customer's technical experts. ON Semiconductor does not convey any license under its patent rights nor the rights of others. ON Semiconductor products are not designed, intended, or authorized for use as a critical component in life support systems or any FDA Class 3 medical devices or medical devices with a same or similar classification in a foreign jurisdiction or any devices intended for implantation in the human body. Should Buyer purchase or use ON Semiconductor products for any such unintended or unauthorized application, Buyer shall indemnify and hold ON Semiconductor and its officers, employees, subsidiaries, affiliates, and distributors harmless against all claims, costs, damages, and expenses, and reasonable attorney fees arising out of, directly or indirectly, any claim of personal injury or death associated with such unintended or unauthorized use, even if such claim alleges that ON Semiconductor was negligent regarding the design or manufacture of the part. ON Semiconductor is an Equal Opportunity/Affirmative Action Employer. This literature is subject to all applicable copyright laws and is not for resale in any manner.

PUBLICATION ORDERING INFORMATION

LITERATURE FULFILLMENT

Literature Distribution Center for ON Semiconductor
19521 E. 32nd Pkwy, Aurora, Colorado 80011 USA
Phone: 303-675-2175 or 800-344-3860 Toll Free USA/Canada
Fax: 303-675-2176 or 800-344-3867 Toll Free USA/Canada
Email: orderlit@onsemi.com

N. American Technical Support: 800-282-9855 Toll Free
USA/Canada
Europe, Middle East and Africa Technical Support:
Phone: 421 33 790 2910
Japan Customer Focus Center
Phone: 81-3-5817-1050

ON Semiconductor Website: www.onsemi.com

Order Literature: <http://www.onsemi.com/orderlit>

For additional information, please contact your local Sales Representative