



Is Now Part of



ON Semiconductor®

To learn more about ON Semiconductor, please visit our website at
www.onsemi.com

Please note: As part of the Fairchild Semiconductor integration, some of the Fairchild orderable part numbers will need to change in order to meet ON Semiconductor's system requirements. Since the ON Semiconductor product management systems do not have the ability to manage part nomenclature that utilizes an underscore (_), the underscore (_) in the Fairchild part numbers will be changed to a dash (-). This document may contain device numbers with an underscore (_). Please check the ON Semiconductor website to verify the updated device numbers. The most current and up-to-date ordering information can be found at www.onsemi.com. Please email any questions regarding the system integration to Fairchild_questions@onsemi.com.

ON Semiconductor and the ON Semiconductor logo are trademarks of Semiconductor Components Industries, LLC dba ON Semiconductor or its subsidiaries in the United States and/or other countries. ON Semiconductor owns the rights to a number of patents, trademarks, copyrights, trade secrets, and other intellectual property. A listing of ON Semiconductor's product/patent coverage may be accessed at www.onsemi.com/site/pdf/Patent-Marking.pdf. ON Semiconductor reserves the right to make changes without further notice to any products herein. ON Semiconductor makes no warranty, representation or guarantee regarding the suitability of its products for any particular purpose, nor does ON Semiconductor assume any liability arising out of the application or use of any product or circuit, and specifically disclaims any and all liability, including without limitation special, consequential or incidental damages. Buyer is responsible for its products and applications using ON Semiconductor products, including compliance with all laws, regulations and safety requirements or standards, regardless of any support or applications information provided by ON Semiconductor. "Typical" parameters which may be provided in ON Semiconductor data sheets and/or specifications can and do vary in different applications and actual performance may vary over time. All operating parameters, including "Typicals" must be validated for each customer application by customer's technical experts. ON Semiconductor does not convey any license under its patent rights nor the rights of others. ON Semiconductor products are not designed, intended, or authorized for use as a critical component in life support systems or any FDA Class 3 medical devices or medical devices with a same or similar classification in a foreign jurisdiction or any devices intended for implantation in the human body. Should Buyer purchase or use ON Semiconductor products for any such unintended or unauthorized application, Buyer shall indemnify and hold ON Semiconductor and its officers, employees, subsidiaries, affiliates, and distributors harmless against all claims, costs, damages, and expenses, and reasonable attorney fees arising out of, directly or indirectly, any claim of personal injury or death associated with such unintended or unauthorized use, even if such claim alleges that ON Semiconductor was negligent regarding the design or manufacture of the part. ON Semiconductor is an Equal Opportunity/Affirmative Action Employer. This literature is subject to all applicable copyright laws and is not for resale in any manner.



FPAM30LH60

用于两相交错式功率因数校正的 PFC SPM[®] 2 系列

特性

- 通过 UL 第 E209204 号认证 (UL1557)
- 600 V - 30 A 两相交错式功率因数校正, 包含栅极驱动和保护的控制 IC
- 采用 DBC (Al₂O₃) 基板实现非常低的热阻
- 全波桥式整流器和高性能输出二极管
- 针对 20 kHz 开关频率进行优化
- 内置负温度系数热敏电阻可实现温度监测
- 绝缘等级: 2500 V_{rms}/分钟

应用

- 两相交错式功率因数校正转换器

相关资料

• [即将发布](#)

概述

FPAM30LH60 是 PFC SPM[®] 2 模块, 为消费、医药和工业应用提供非常全面的高性能交错式功率因数校正输入功率平台。这些模块综合优化了内置 IGBT 的栅极驱动以最小化电磁干扰和能量损耗。同时也提供多重模组保护特性, 集成欠压闭锁, 过流保护, 热量监测和故障报告。这些模块内的全波整流器和高性能输出二极管, 为额外节省空间和方便安装起到了重要作用。



图 1. 封装概览

封装标识与订购信息

器件	器件标识	封装	包装类型	数量
FPAM30LH60	FPAM30LH60	S32EA-032	Rail	8

集成的驱动、保护和系统控制功能

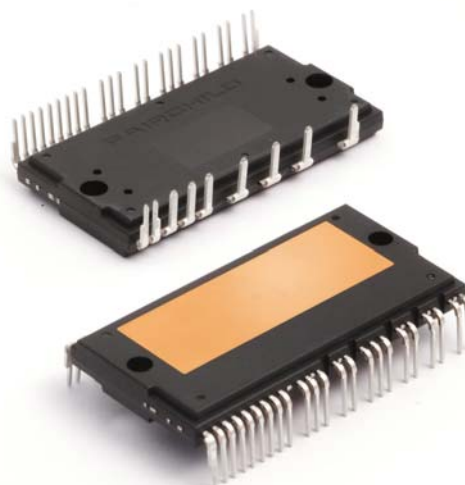
- 对于 IGBT: 栅极驱动电路、过流保护 (OCP)、控制电源欠压锁定 (UVLO) 保护
- 故障信号: 对应 OC 和 UV 故障
- 内置热敏电阻: 温度监控
- 输入接口: 高电平有效接口, 可用于 3.3 / 5 V 逻辑电平, 施密特触发脉冲输入

引脚布局



图 2. 俯视图

引脚描述

引脚号	引脚名	引脚描述
1	C _{SC}	过流检测的信号输入
2,6,10	COM	公共电源接地
3	V _{FO}	故障输出
4	IN _X	X IGBT 驱动的 PWM 输入
5	IN _Y	Y IGBT 驱动的 PWM 输入
7	N.C	无连接
8,9	V _{CC}	适用于 IGBT 驱动的 IC 的公共电源电压
11	R _{TH}	供热敏电阻使用的串联电阻器
12	V _{TH}	热敏电阻偏压
13,14	N _R	整流二极管的直流负端
15,16,17	N.C	无连接
18,19	R	R 相的交流输入
20,21	N.C	无连接
22,23	S	S 相的交流输入
24,25	P	二极管的输出
26	P _Y	二极管的输入
27	N.C	无连接
28	P _X	二极管的输入
29	X	X 相 IGBT 的输出
30	Y	Y 相 IGBT 的输出
31	N _P	IGBT 的直流负端
32	P _R	整流二极管的直流正端

内部等效电路

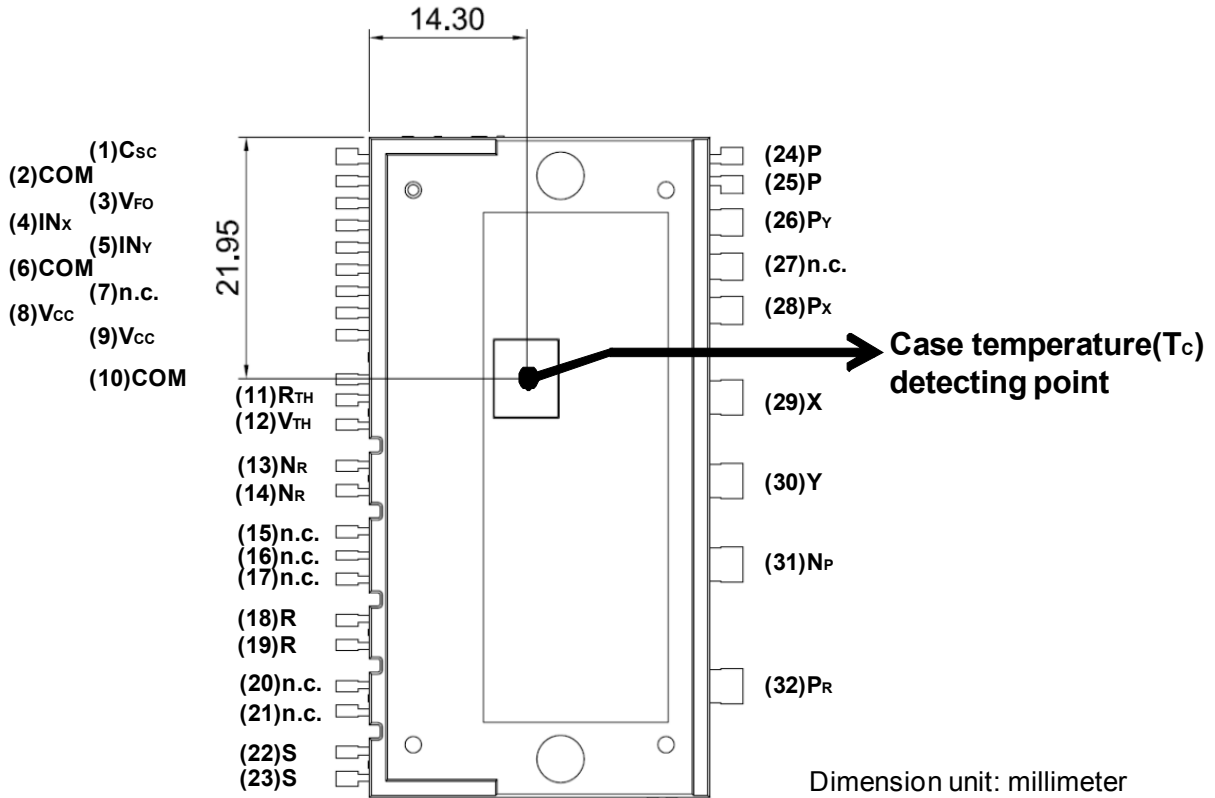

图 3. 内部框图

绝对最大额定值 ($T_J = 25^\circ\text{C}$, 除非另有说明。)**转换器部分**

符号	参数	工作条件	额定值	单位
V_i	输入电源电压	施加在 R - S 之间	264	V_{rms}
V_{PN}	输出电压	施加在 X - N _P , Y - N _P , P - P _X , P - P _Y	450	V
V_{PN} (浪涌)	输出电源电压 (浪涌)	施加在 X - N _P , Y - N _P , P - P _X , P - P _Y	500	V
V_{CES}	集电极 - 发射极之间电压	X - N _P , Y - N _P 之间的击穿电压	600	V
V_{RRM}	快速恢复二极管的重复峰值反向电压	P - P _X , P - P _Y 之间的击穿电压	600	V
V_{RRMR}	整流器的重复峰值反向电压	P _R - R, P _R - S, R - N _R , S - N _R 之间的击穿电压	900	V
* I_F	快速恢复二极管的正向电流	$T_C = 25^\circ\text{C}$, $T_J < 125^\circ\text{C}$	30	A
* I_{FSM}	快速恢复二极管的峰值浪涌电流	非重复性, 60 Hz 单一正弦半波	300	A
* I_{FR}	正向整流电流	$T_C = 25^\circ\text{C}$, $T_J < 125^\circ\text{C}$	30	A
* I_{FSMR}	整流器的峰值浪涌电流	非重复性, 60 Hz 单一正弦半波	300	A
$\pm I_{IC}$	单个 IGBT 的集电极电流	$T_C = 25^\circ\text{C}$, $T_J < 125^\circ\text{C}$	30	A
$\pm I_{ICP}$	单个 IGBT 的集电极电流 (峰值)	$T_C = 25^\circ\text{C}$, $T_J < 125^\circ\text{C}$, 脉冲宽度小于 1 ms	60	A
* P_C	集电极功耗	$T_C = 25^\circ\text{C}$ 单个 IGBT	107	W
T_J	工作结温	(注 1)	-40 ~ 125	$^\circ\text{C}$

注:

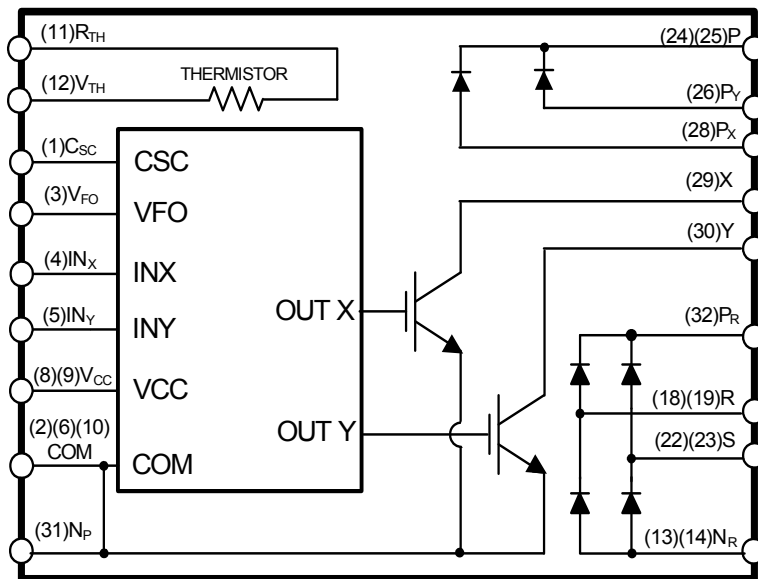
1. PFC SPM® 产品集成的功率芯片的最大额定结温是 125 $^\circ\text{C}$ 。
2. 标记为 "*" 的为计算值或设计因素。

控制部分

符号	参数	工作条件	额定值	单位
V_{CC}	控制电源电压	施加在 V_{CC} - COM 之间	20	V
V_{IN}	输入信号电压	施加在 IN _X , IN _Y - COM 之间	-0.3 ~ $V_{CC} + 0.3$	V
V_{FO}	故障输出电源电压	施加在 V_{FO} - COM 之间	-0.3 ~ $V_{CC} + 0.3$	V
I_{FO}	故障输出电流	V_{FO} 引脚处的灌电流	1	mA
V_{SC}	电流感测输入电压	施加在 C_{SC} - COM 之间	-0.3 ~ $V_{CC} + 0.3$	V

整个系统

符号	参数	工作条件	额定值	单位
T_{STG}	存储温度		-40 ~ 125	$^\circ\text{C}$
V_{ISO}	绝缘电压	60 Hz, 正弦波形, 交流 1 分钟, 连接陶瓷基板到引脚	2500	V_{rms}

热阻

符号	参数	条件	最小值	典型值	最大值	单位
$R_{th(j-c)Q}$	结点 - 壳体的热阻	工作条件下的单个 IGBT	-	-	0.93	$^\circ\text{C/W}$
$R_{th(j-c)D}$		工作条件下的单个二极管	-	-	1.42	$^\circ\text{C/W}$
$R_{th(j-c)R}$		工作条件下的单个整流器	-	-	0.74	$^\circ\text{C/W}$

电气特性 (T_J = 25°C, 除非另有说明。)

转换器部分

符号	参数	工作条件	最小值	典型值	最大值	单位
V _{CE(SAT)}	IGBT 饱和电压	V _{CC} = 15 V, V _{IN} = 5 V, I _C = 30 A	-	1.7	2.2	V
V _{FF}	快速恢复二极管正向电压	I _F = 30 A	-	1.9	2.4	V
V _{FR}	整流器正向电压	I _{FR} = 30 A	-	1.10	1.25	V
I _{RR}	开关特性	V _{PN} = 400 V, V _{CC} = 15 V, I _C = 15 A, V _{IN} = 0 V ↔ 5 V, 感性负载 (注 3), 单个 IGBT	-	11	-	A
t _{RR}			-	41	-	ns
t _{ON}			-	700	-	ns
t _{OFF}			-	852	-	ns
t _{C(ON)}			-	104	-	ns
t _{C(OFF)}			-	102	-	ns
I _{CES}	集电极 - 发射极间漏电流	V _{CES} = 600 V	-	-	250	μA

注:

3. t_{ON} 和 t_{OFF} 包括模块内部驱动 IC 的传输延迟时间。t_{C(ON)} 和 t_{C(OFF)} 指在内部给定的栅极驱动条件下, IGBT 本身的开关时间。详细信息, 请参见图 4。



图 4. 开关时间的定义

控制部分

符号	参数	工作条件	最小值	典型值	最大值	单位
I_{OCC}	V_{CC} 静态电源电流	$V_{CC} = 15\text{ V}$, IN_X , $IN_Y - COM = 0\text{ V}$, V_{CC} 和 COM 间的电源电流	-	-	2.65	mA
I_{PCC}	工作 V_{CC} 电源电流	$V_{CC} = 15\text{ V}$, $f_{PWM} = 20\text{ kHz}$, $Duty = 50\%$ 应用于单个 IGBT 的一个 PWM 信号输入 V_{CC} 和 COM 间的电源电流	-	-	6.0	mA
V_{FOH}	故障输出电压	$V_{SC} = 0\text{ V}$, V_{FO} 电路: $10\text{ k}\Omega$ 至 5 V 上拉	4.5	-	-	V
V_{FOL}		$V_{SC} = 1\text{ V}$, V_{FO} 电路: $10\text{ k}\Omega$ 至 5 V 上拉	-	-	0.5	V
$V_{SC(Ref)}$	CSC 引脚的过流保护触发电平电压	$V_{CC} = 15\text{ V}$	0.45	0.50	0.55	V
UV_{CCD}	电源电路欠压保护	检测电平	10.5	-	13.0	V
UV_{CCR}		复位电平	11.0	-	13.5	V
t_{FOD}	故障输出脉宽		30	-	-	μs
$V_{IN(ON)}$	导通阈值电压	施加在 IN_X , $IN_Y - COM$ 之间	2.6	-	-	V
$V_{IN(OFF)}$	关断阈值电压	施加在 IN_X , $IN_Y - COM$ 之间	-	-	0.8	V
R_{TH}	热敏电阻的阻值	当 $T_{TH} = 25^\circ\text{C}$ (注 4, 图 5)	-	47	-	$\text{k}\Omega$
		当 $T_{TH} = 100^\circ\text{C}$ (注 4, 图 5)	-	2.9	-	$\text{k}\Omega$

注:

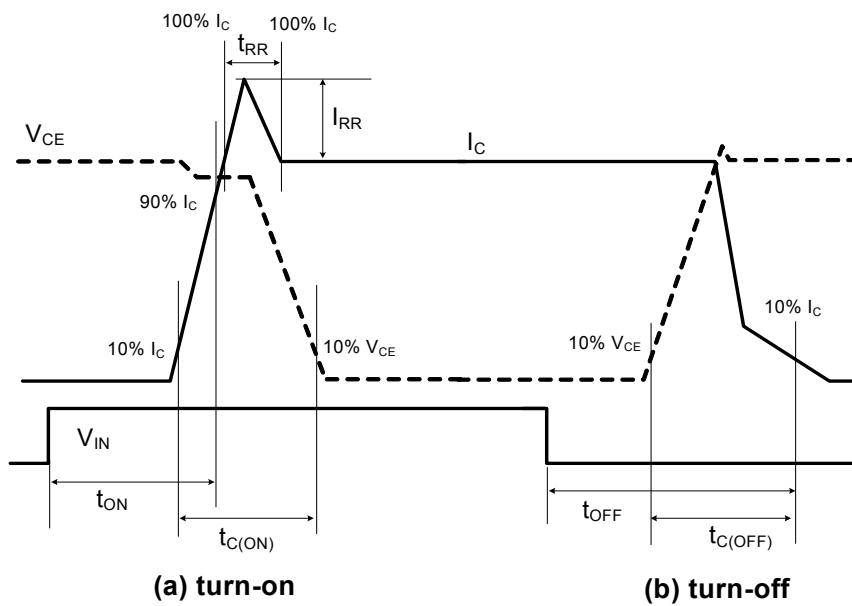
4. T_{TH} 为热敏电阻自身的温度。若需得到壳体温度 (T_C), 请根据具体应用进行实验。

图 5. 内置热敏电阻的 R-T 曲线

推荐工作条件 ($T_J = 25^\circ\text{C}$, 除非另有说明。)

符号	参数	工作条件	最小值	典型值	最大值	单位
V_i	输入电源电压	施加在 R - S 之间	187	-	253	V_{rms}
I_i	输入电流	$T_C < 100^\circ\text{C}$, $V_i = 220\text{ V}$, $V_O = 360\text{ V}$, $f_{PWM} = 20\text{ kHz}$ 单个 IGBT	-	-	21	A_{rms}
V_{PN}	电源电压	施加在 X - N _P , Y - N _P , P - P _X , P - P _Y	-	-	400	V
V_{CC}	控制电源电压	施加在 V_{CC} - COM 之间	13.5	15.0	16.5	V
dV_{CC}/dt	电源波动		-1	-	1	$V/\mu\text{s}$
I_{FO}	故障输出电流	V_{FO} 引脚处的灌电流	-	-	1	mA
f_{PWM}	PWM 输入频率	$-40^\circ\text{C} < T_J < 125^\circ\text{C}$ 单个 IGBT	-	20	-	kHz

机械特性和额定值

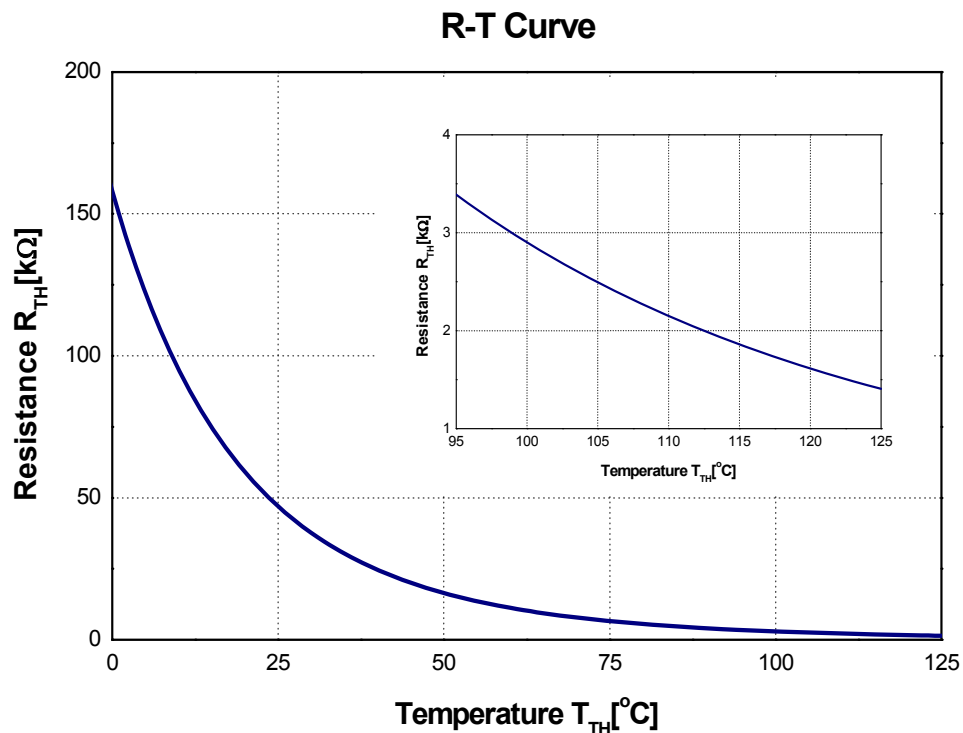
参数	工作条件		最小值	典型值	最大值	单位
安装扭矩	安装螺钉: M4	建议 0.98 N•m	0.78	0.98	1.17	N•m
		建议 10 kg•cm	8	10	12	kg•cm
器件平面度	见图 6		0	-	+150	μm
重量			-	32	-	g



图 6. 平面度测量位置

保护功能时序图

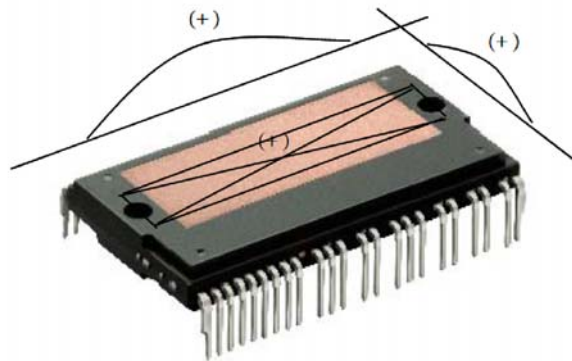
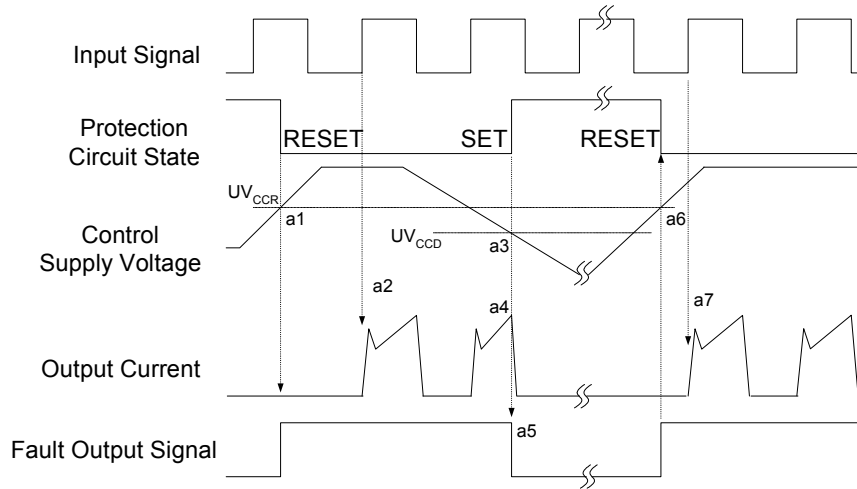

- a1: 控制电源电压上升: 当电压上升到 UV_{CCR} 后, 等到下一个开通信号时, 对应的电路才开始动作。
- a2: 正常工作: IGBT 导通并加载负载电流。
- a3: 欠压检测 (UV_{CCD})。
- a4: 不论控制输入的条件, IGBT 都关断。
- a5: 故障输出工作启动。
- a6: 欠压复位 (UV_{CCR})。
- a7: 正常工作: IGBT 导通并加载负载电流。

图 7. 欠压保护

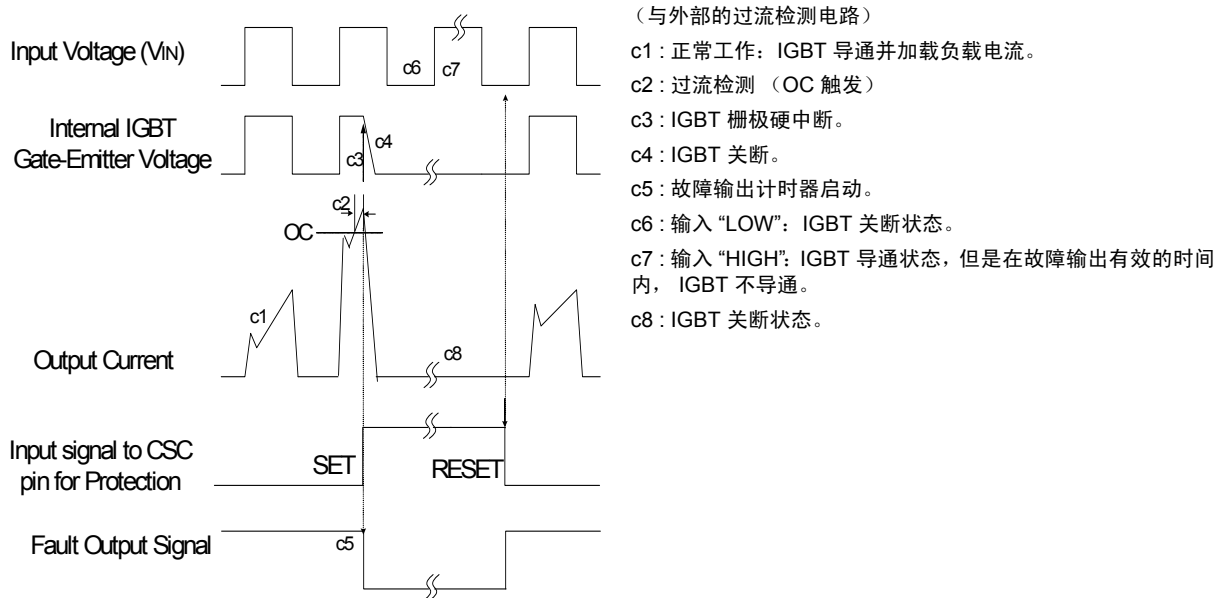

(与外部的过流检测电路)

- c1: 正常工作: IGBT 导通并加载负载电流。
- c2: 过流检测 (OC 触发)
- c3: IGBT 栅极硬中断。
- c4: IGBT 关断。
- c5: 故障输出计时器启动。
- c6: 输入 "LOW": IGBT 关断状态。
- c7: 输入 "HIGH": IGBT 导通状态, 但是在故障输出有效的时间内, IGBT 不导通。
- c8: IGBT 关断状态。

图 8. 过流保护



图 9. 典型应用电路

注:

1. 为了避免故障，每个输入端的连线必须尽可能的短（小于 2 ~ 3 cm）。
2. V_{F0} 输出是漏极开路型。该信号线应当采用一个能把 I_{F0} 上升到 1 mA 的电阻上拉至 MCU 或控制电源的正极。
3. 输入信号为高电平有效。在 IC 中，有一个 5 kΩ 的电阻将每一个输入信号线下拉接地。应采用 RC 耦合电路，以避免输入信号波动。R_FC_F 常数应当在 50~150ns 范围内选择（推荐 R_F = 100 Ω，C_F = 1 nF）。
4. 为避免保护功能出错，应尽可能缩短 R_{SCF} 和 C_{SCF} 周围的连线。
5. 在短路保护电路中，R_{SCF}、C_{SCF} 时间常数应在 1.5 ~ 2 μs 范围内进行选择。
6. 每个电容都应尽可能地靠近 PFC SPM[®] 产品的引脚安装。
7. 在各种家用电器设备中，几乎都用到了继电器。在这些情况下，MCU / 控制器和继电器之间应留有足够的距离。
8. 内部负温度系数热敏电阻用来监控壳体温度，以及保护器件免于过热工作。根据应用选择一个适当的电阻 R_T。
9. 建议将反向并联二极管 (D_X, D_Y) 与每个 IGBT 相连接。

封装轮廓详图

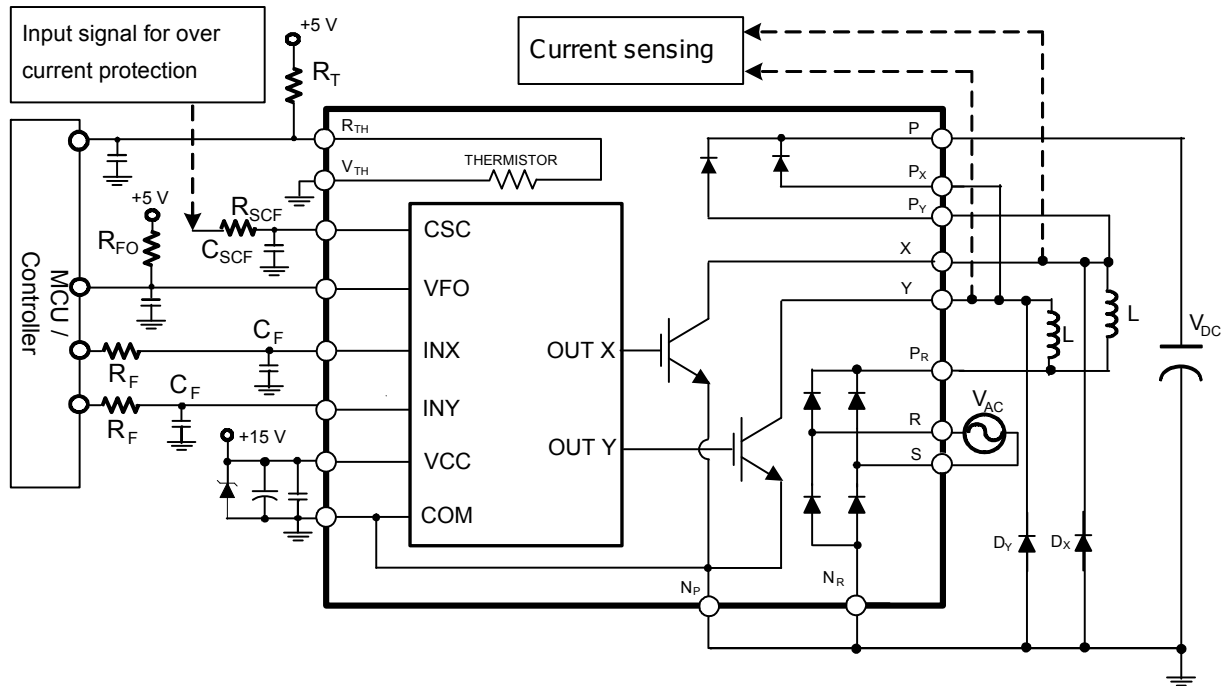
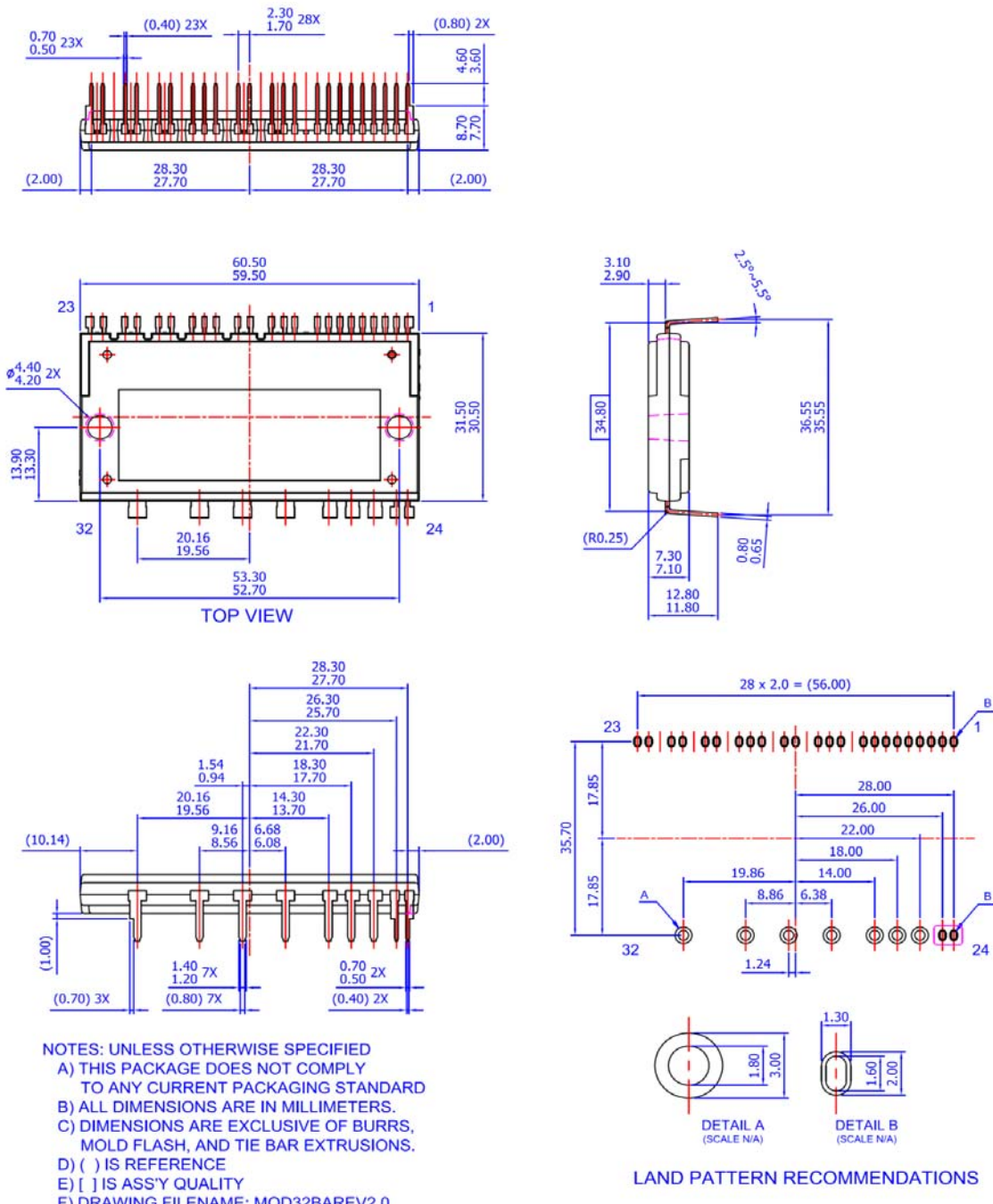

封装图纸作为一项服务，提供给考虑飞兆半导体元件的客户。具体参数可能会有变化，且不会做出相应通知。请注意图纸上的版本和 / 或日期，并联系飞兆半导体代表核实或获得最新版本。封装规格并不扩大飞兆公司全球范围内的条款与条件，尤其是其中涉及飞兆公司产品保修的部分。





随时访问飞兆半导体在线封装网页，可以获取最新的封装图纸：

<http://www.fairchildsemi.com/dwg/MO/MOD32BA.pdf>

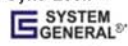

TRADEMARKS

The following includes registered and unregistered trademarks and service marks, owned by Fairchild Semiconductor and/or its global subsidiaries, and is not intended to be an exhaustive list of all such trademarks.

AccuPower™	F-PFS™		Sync-Lock™
AX-CAP®*	FRFET®	PowerTrench®	 SYSTEM GENERAL®
BitSiC™	Global Power Resource™	PowerXS™	TinyBoost®
Build it Now™	GreenBridge™	Programmable Active Droop™	TinyBuck®
CorePLUS™	Green FPS™	QFET®	TinyCalc™
CorePOWER™	Green FPS™ e-Series™	QS™	TinyLogic®
CROSSVOLT™	Gmax™	Quiet Series™	TINYOPTO™
CTL™	GTO™	RapidConfigure™	TinyPower™
Current Transfer Logic™	IntelliMAX™	 Saving our world, 1mW/W/kW at a time™	TinyPWM™
DEUXPEED®	ISOPLANAR™	SignalWise™	TinyWire™
Dual Cool™	Making Small Speakers Sound Louder and Better™	SmartMax™	TranSiC™
EcoSPARK®	MegaBuck™	SMART START™	TriFault Detect™
EfficientMax™	MICROCOUPLER™	Solutions for Your Success™	TRUECURRENT®*
ESBC™	MicroFET™	SPM®	 SerDes®
	MicroPak™	STEALTH™	UHC®
Fairchild®	MicroPak2™	SuperFET®	Ultra FRFET™
Fairchild Semiconductor®	MillerDrive™	SuperSOT™-3	UniFET™
FACT Quiet Series™	MotionMax™	SuperSOT™-6	VCX™
FACT®	mWSaver®	SuperSOT™-8	VisualMax™
FAST®	OptoHit™	SupreMOS®	VoltagePlus™
FastvCore™	OPTOLOGIC®	SyncFET™	XS™
FETBench™	OPTOPLANAR®		
FPS™			

* Trademarks of System General Corporation, used under license by Fairchild Semiconductor.

DISCLAIMER

FAIRCHILD SEMICONDUCTOR RESERVES THE RIGHT TO MAKE CHANGES WITHOUT FURTHER NOTICE TO ANY PRODUCTS HEREIN TO IMPROVE RELIABILITY, FUNCTION, OR DESIGN. FAIRCHILD DOES NOT ASSUME ANY LIABILITY ARISING OUT OF THE APPLICATION OR USE OF ANY PRODUCT OR CIRCUIT DESCRIBED HEREIN; NEITHER DOES IT CONVEY ANY LICENSE UNDER ITS PATENT RIGHTS, NOR THE RIGHTS OF OTHERS. THESE SPECIFICATIONS DO NOT EXPAND THE TERMS OF FAIRCHILD'S WORLDWIDE TERMS AND CONDITIONS, SPECIFICALLY THE WARRANTY THEREIN, WHICH COVERS THESE PRODUCTS.

LIFE SUPPORT POLICY

FAIRCHILD'S PRODUCTS ARE NOT AUTHORIZED FOR USE AS CRITICAL COMPONENTS IN LIFE SUPPORT DEVICES OR SYSTEMS WITHOUT THE EXPRESS WRITTEN APPROVAL OF FAIRCHILD SEMICONDUCTOR CORPORATION.

As used herein:

1. Life support devices or systems are devices or systems which, (a) are intended for surgical implant into the body or (b) support or sustain life, and (c) whose failure to perform when properly used in accordance with instructions for use provided in the labeling, can be reasonably expected to result in a significant injury of the user.
2. A critical component in any component of a life support, device, or system whose failure to perform can be reasonably expected to cause the failure of the life support device or system, or to affect its safety or effectiveness.

ANTI-COUNTERFEITING POLICY

Fairchild Semiconductor Corporation's Anti-Counterfeiting Policy. Fairchild's Anti-Counterfeiting Policy is also stated on our external website, www.fairchildsemi.com, under Sales Support.

Counterfeiting of semiconductor parts is a growing problem in the industry. All manufacturers of semiconductor products are experiencing counterfeiting of their parts. Customers who inadvertently purchase counterfeit parts experience many problems such as loss of brand reputation, substandard performance, failed applications, and increased cost of production and manufacturing delays. Fairchild is taking strong measures to protect ourselves and our customers from the proliferation of counterfeit parts. Fairchild strongly encourages customers to purchase Fairchild parts either directly from Fairchild or from Authorized Fairchild Distributors who are listed by country on our web page cited above. Products customers buy either from Fairchild directly or from Authorized Fairchild Distributors are genuine parts, have full traceability, meet Fairchild's quality standards for handling and storage and provide access to Fairchild's full range of up-to-date technical and product information. Fairchild and our Authorized Distributors will stand behind all warranties and will appropriately address any warranty issues that may arise. Fairchild will not provide any warranty coverage or other assistance for parts bought from Unauthorized Sources. Fairchild is committed to combat this global problem and encourage our customers to do their part in stopping this practice by buying direct or from authorized distributors.

PRODUCT STATUS DEFINITIONS

Definition of Terms

Datasheet Identification	Product Status	Definition
Advance Information	Formative / In Design	Datasheet contains the design specifications for product development. Specifications may change in any manner without notice.
Preliminary	First Production	Datasheet contains preliminary data; supplementary data will be published at a later date. Fairchild Semiconductor reserves the right to make changes at any time without notice to improve design.
No Identification Needed	Full Production	Datasheet contains final specifications. Fairchild Semiconductor reserves the right to make changes at any time without notice to improve the design.
Obsolete	Not In Production	Datasheet contains specifications on a product that is discontinued by Fairchild Semiconductor. The datasheet is for reference information only.

Rev. 166

ON Semiconductor and  are trademarks of Semiconductor Components Industries, LLC dba ON Semiconductor or its subsidiaries in the United States and/or other countries. ON Semiconductor owns the rights to a number of patents, trademarks, copyrights, trade secrets, and other intellectual property. A listing of ON Semiconductor's product/patent coverage may be accessed at www.onsemi.com/site/pdf/Patent-Marking.pdf. ON Semiconductor reserves the right to make changes without further notice to any products herein. ON Semiconductor makes no warranty, representation or guarantee regarding the suitability of its products for any particular purpose, nor does ON Semiconductor assume any liability arising out of the application or use of any product or circuit, and specifically disclaims any and all liability, including without limitation special, consequential or incidental damages. Buyer is responsible for its products and applications using ON Semiconductor products, including compliance with all laws, regulations and safety requirements or standards, regardless of any support or applications information provided by ON Semiconductor. "Typical" parameters which may be provided in ON Semiconductor data sheets and/or specifications can and do vary in different applications and actual performance may vary over time. All operating parameters, including "Typicals" must be validated for each customer application by customer's technical experts. ON Semiconductor does not convey any license under its patent rights nor the rights of others. ON Semiconductor products are not designed, intended, or authorized for use as a critical component in life support systems or any FDA Class 3 medical devices or medical devices with a same or similar classification in a foreign jurisdiction or any devices intended for implantation in the human body. Should Buyer purchase or use ON Semiconductor products for any such unintended or unauthorized application, Buyer shall indemnify and hold ON Semiconductor and its officers, employees, subsidiaries, affiliates, and distributors harmless against all claims, costs, damages, and expenses, and reasonable attorney fees arising out of, directly or indirectly, any claim of personal injury or death associated with such unintended or unauthorized use, even if such claim alleges that ON Semiconductor was negligent regarding the design or manufacture of the part. ON Semiconductor is an Equal Opportunity/Affirmative Action Employer. This literature is subject to all applicable copyright laws and is not for resale in any manner.

PUBLICATION ORDERING INFORMATION

LITERATURE FULFILLMENT:

Literature Distribution Center for ON Semiconductor
19521 E. 32nd Pkwy, Aurora, Colorado 80011 USA
Phone: 303-675-2175 or 800-344-3860 Toll Free USA/Canada
Fax: 303-675-2176 or 800-344-3867 Toll Free USA/Canada
Email: orderlit@onsemi.com

N. American Technical Support: 800-282-9855 Toll Free
USA/Canada
Europe, Middle East and Africa Technical Support:
Phone: 421 33 790 2910
Japan Customer Focus Center
Phone: 81-3-5817-1050

ON Semiconductor Website: www.onsemi.com
Order Literature: <http://www.onsemi.com/orderlit>
For additional information, please contact your local
Sales Representative