

MOSFET – P-Channel, POWERTRENCH

-20 V, -4 A, 100 mΩ

FDC642P-F085, FDC642P-F085P

Features

- Typ $R_{DS(on)}$ = 52.5 mΩ at $V_{GS} = -4.5$ V, $I_D = -4$ A
- Typ $R_{DS(on)}$ = 75.3 mΩ at $V_{GS} = -2.5$ V, $I_D = -3.2$ A
- Fast Switching Speed
- Low Gate Charge (6.9 nC Typical)
- High Performance Trench Technology for Extremely Low $R_{DS(on)}$
- SUPERSOT™ –6 Package: Small Footprint (72% Smaller than Standard SO–8); Low Profile (1 mm Thick)
- AEC–Q101 Qualified and PPAP Capable
- This Device is Pb–Free and is RoHS Compliant

Applications

- Load Switch
- Battery Protection
- Power management



ON Semiconductor®

www.onsemi.com

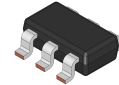

TSOT23 6–Lead
CASE 419BL

MARKING DIAGRAM

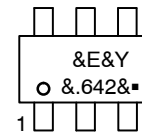

XXX = Specific Device Code
 &E = Space Designator
 &Y = Year of Production
 &. = Pin One Identifier
 ▪ = Pb–Free Package

PINOUT

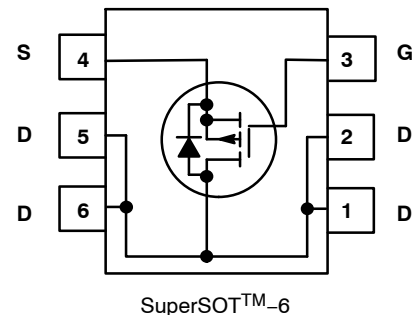

ORDERING INFORMATION

See detailed ordering and shipping information on page 2 of this data sheet.

FDC642P-F085, FDC642P-F085P

MOSFET MAXIMUM RATINGS ($T_A = 25^\circ\text{C}$ unless otherwise noted)

Symbol	Parameter	Ratings	Units
V_{DSS}	Drain to Source Voltage	-20	V
V_{GS}	Gate to Source Voltage	± 8	V
I_D	Drain Current - Continuous ($V_{GS} = 4.5\text{ V}$) - Pulsed	-4 -20	A
E_{AS}	Single Pulse Avalanche Energy (Note 1)	72	mJ
P_D	Power Dissipation	1.2	W
T_J, T_{STG}	Operating and Storage Temperature	-55 to +150	$^\circ\text{C}$

Stresses exceeding those listed in the Maximum Ratings table may damage the device. If any of these limits are exceeded, device functionality should not be assumed, damage may occur and reliability may be affected.

1. Starting $T_J = 25^\circ\text{C}$, $L = 14.1\text{ mH}$, $I_{AS} = -3.2\text{ A}$

THERMAL CHARACTERISTICS

Symbol	Parameter	Ratings	Units
$R_{\theta JC}$	Thermal Resistance, Junction to Case	30	$^\circ\text{C/W}$
$R_{\theta JA}$	Thermal Resistance, Junction to Ambient, 1 in^2 Copper pad Area	103	

PACKAGE MARKING AND ORDERING INFORMATION

Device Marking	Device	Package	Reel Size	Tape Width	Quantity
FDC642P	FDC642P-F085	SSOT-6	7"	8 mm	3000 Units
FDC642P	FDC642P-F085P	SSOT-6	7"	8 mm	3000 Units

FDC642P–F085, FDC642P–F085P

ELECTRICAL CHARACTERISTICS (T_J = 25°C unless otherwise noted)

Symbol	Parameter	Test Conditions	Min	Typ	Max	Units
--------	-----------	-----------------	-----	-----	-----	-------

OFF CHARACTERISTICS

B _V DSS	Drain to Source Breakdown Voltage	I _D = 250 μA, V _{GS} = 0 V	-20	-	-	V
I _{DSS}	Zero Gate Voltage Drain Current	V _{DS} = -16 V, V _{GS} = 0 V	-	-	-1	μA
		V _{DS} = -16 V, V _{GS} = 0 V, T _A = 150°C	-	-	-250	
I _{GSS}	Gate to Source Leakage Current	V _{GS} = ±8 V	-	-	±100	nA

ON CHARACTERISTICS

V _{GS(th)}	Gate to Source Threshold Voltage	V _{GS} = V _{DS} , I _D = -250 μA	-0.4	-0.7	-1.5	V
r _{DS(on)}	Drain to Source On Resistance	V _{GS} = -4.5 V, I _D = -4 A	-	52.5	65	mΩ
		V _{GS} = -2.5 V, I _D = -3.2 A	-	75.3	100	
		V _{GS} = 4.5 V, I _D = -4 A, T _J = 125 °C	-	72.7	105	
g _{FS}	Forward Transconductance	V _{DD} = -5 V, I _D = -4 A	-	10	-	S

DYNAMIC CHARACTERISTICS

C _{iss}	Input Capacitance	V _{GS} = 0 V, V _{DS} = -10 V	-	630	-	pF
C _{oss}	Output Capacitance	f = 1 MHz	-	160	-	pF
C _{rss}	Reverse Transfer Capacitance		-	65	-	pF
R _g	Gate Resistance	f = 1 MHz	-	4.4	-	Ω
Q _{g(TOT)}	Total Gate Charge at -4.5 V	V _{GS} = 0 V to -4.5 V, V _{DD} = -10 V, I _D = -4 A	-	6.9	9.0	nC
Q _{gs}	Gate to Source Gate Charge	V _{DD} = -10 V	-	1.2	-	nC
Q _{gd}	Gate to Drain "Miller" Charge	I _D = -4 A	-	1.8	-	nC

SWITCHING CHARACTERISTICS

t _{on}	Turn-On Time	V _{DD} = -10 V, I _D = -1 A, V _{GS} = -4.5 V, R _{GS} = 6 Ω	-	-	23	ns
t _{d(on)}	Turn-On Delay Time		-	7.3	-	ns
t _r	Rise Time		-	5.5	-	ns
t _{d(off)}	Turn-Off Delay Time		-	23.2	-	ns
t _f	Fall Time		-	9.6	-	ns
t _{off}	Turn-Off Time		-	-	53	ns

DRAIN-SOURCE DIODE CHARACTERISTICS

V _{SD}	Source to Drain Diode Voltage	I _{SD} = -1.3 A	-	-	-1.25	V
		I _{SD} = -0.65 A	-	-	-1.0	
t _{rr}	Reverse Recovery Time	I _{SD} = -1.3 A, dI _{SD} /dt = 100 A/μs	-	17	22	ns
Q _{rr}	Reverse Recovery Charge		-	5.6	7.3	nC

Product parametric performance is indicated in the Electrical Characteristics for the listed test conditions, unless otherwise noted. Product performance may not be indicated by the Electrical Characteristics if operated under different conditions.

TYPICAL CHARACTERISTICS

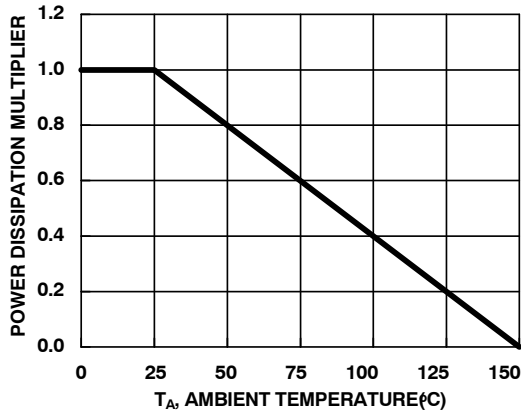

Figure 1. Normalized Power Dissipation vs. Ambient Temperature

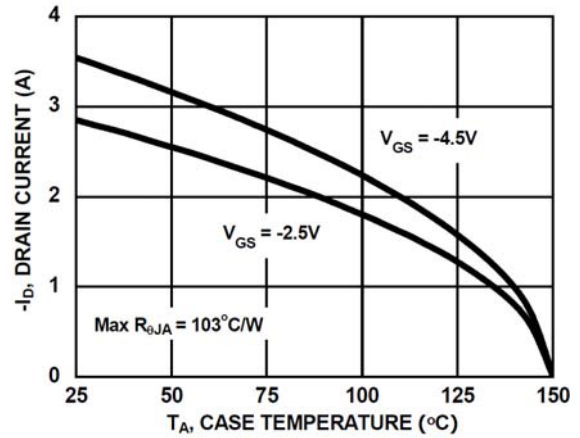

Figure 2. Maximum Continuous Drain Current vs. Ambient Temperature

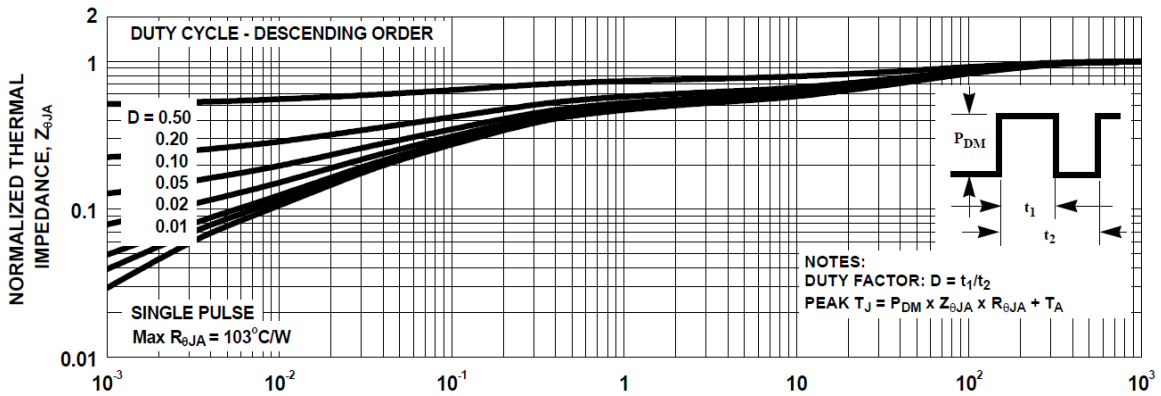

Figure 3. Normalized Maximum Transient Thermal Impedance

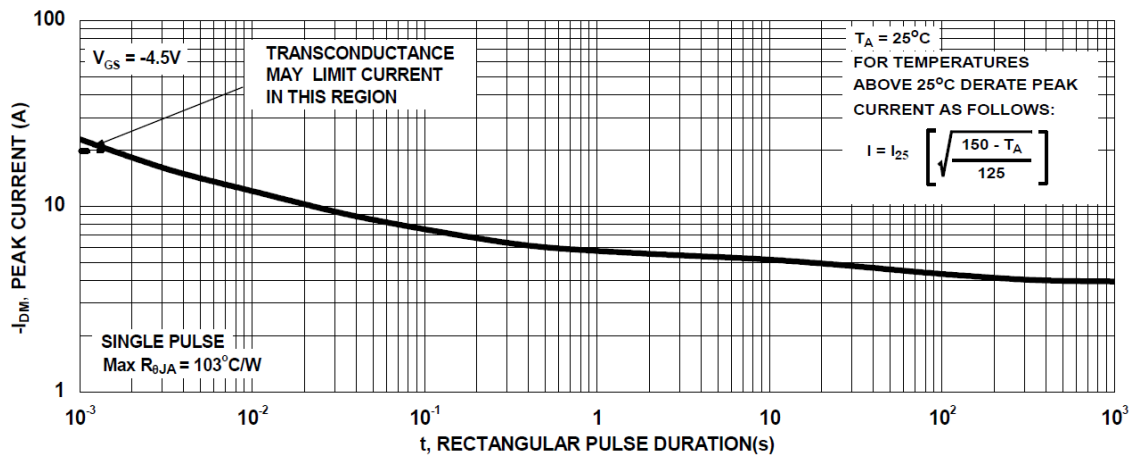

Figure 4. Peak Current Capability

TYPICAL CHARACTERISTICS (continued)

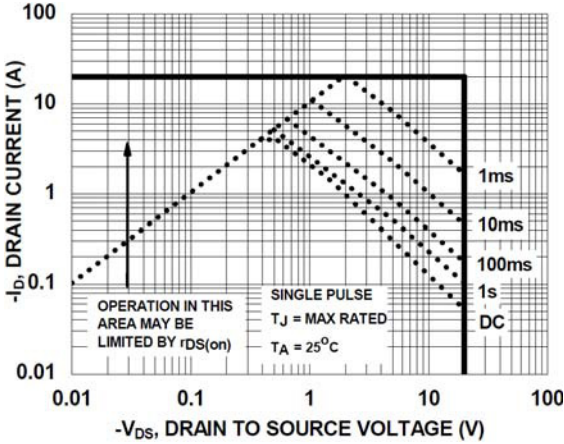

Figure 5. Forward Bias Safe Operating Area

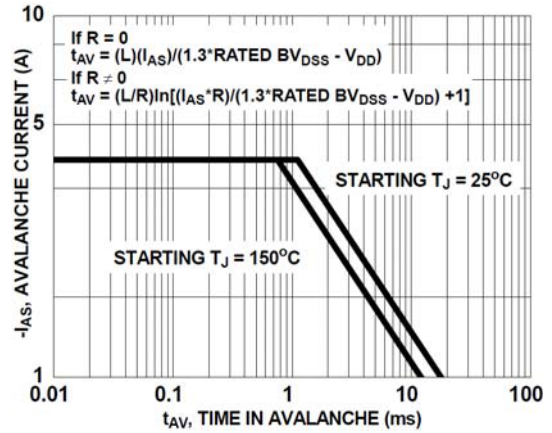

Figure 6. Unclamped Inductive Switching Capability

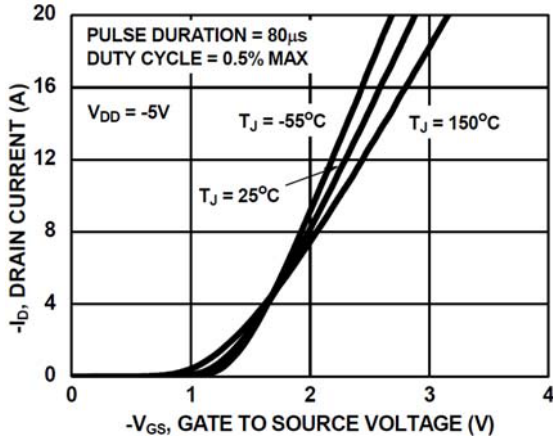

Figure 7. Transfer Characteristics

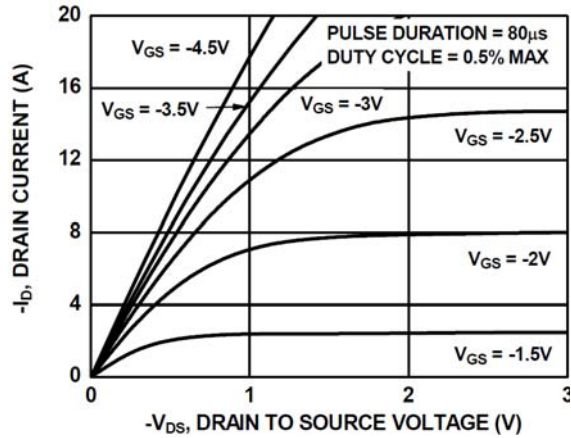

Figure 8. Saturation Characteristics

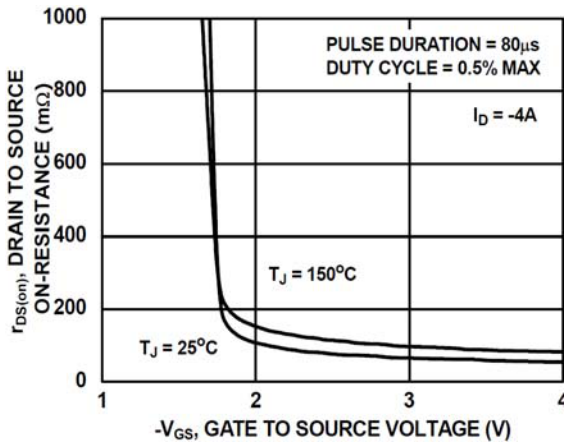

Figure 9. Drain to Source On-Resistance Variation vs. Gate to Source Voltage

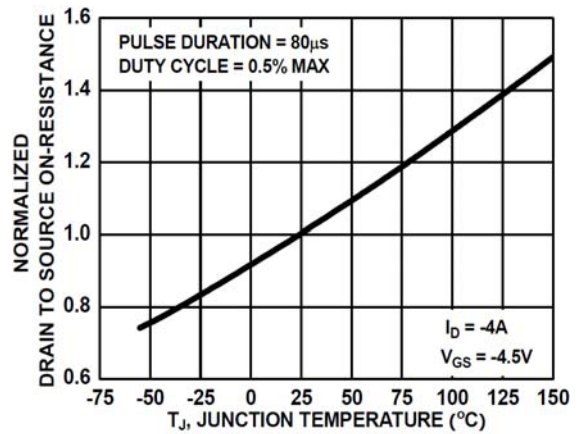

Figure 10. Normalized Drain to Source On-Resistance vs. Junction Temperature

FDC642P-F085, FDC642P-F085P

TYPICAL CHARACTERISTICS $T_J = 25^\circ\text{C}$ unless otherwise noted (continued)

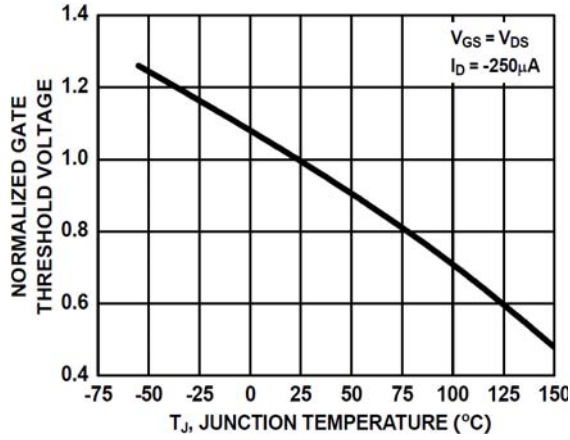

Figure 11. Normalized Gate Threshold Voltage vs. Junction Temperature

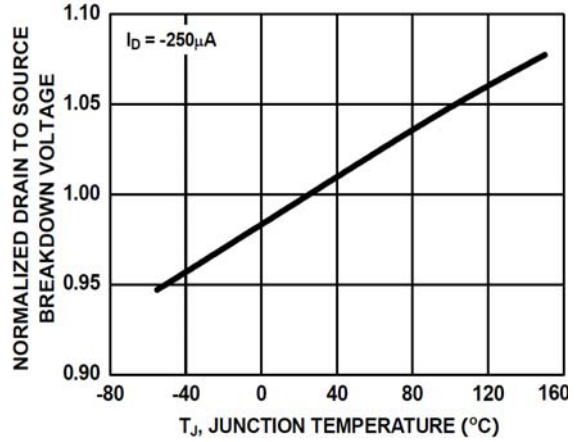

Figure 12. Normalized Drain to Source Breakdown Voltage vs. Junction Temperature

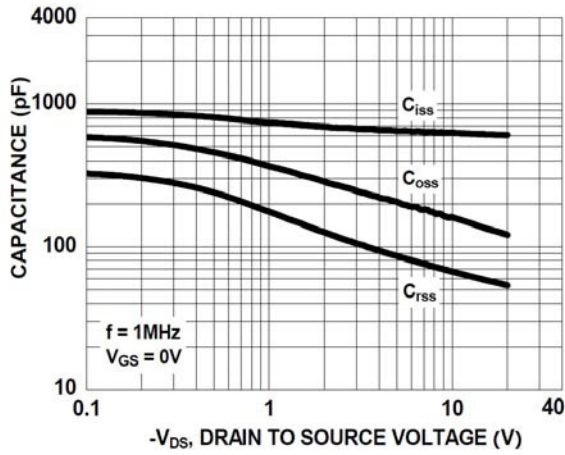

Figure 13. Capacitance vs. Drain to Source Voltage

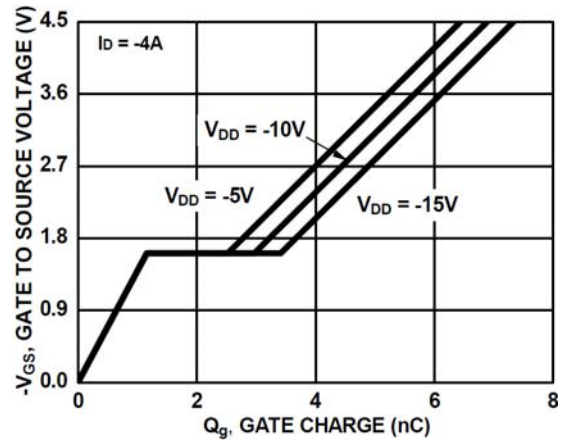

Figure 14. Gate Charge vs. Gate to Source Voltage

POWERTRENCH is registered trademark of Semiconductor Components Industries, LLC (SCILLC) or its subsidiaries in the United States and/or other countries.

SUPERSOT is trademark of Semiconductor Components Industries, LLC (SCILLC) or its subsidiaries in the United States and/or other countries.

MECHANICAL CASE OUTLINE

PACKAGE DIMENSIONS

ON Semiconductor®



SCALE 2:1

TSOT23 6-Lead CASE 419BL ISSUE A

DATE 31 AUG 2020

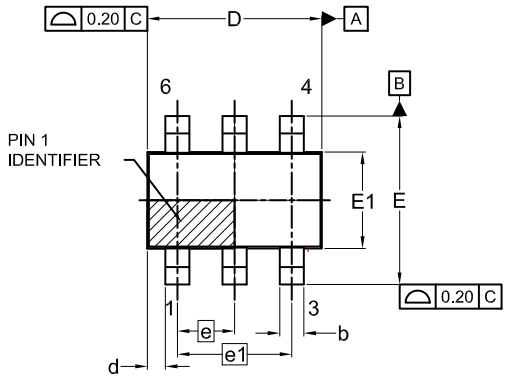

TOP VIEW

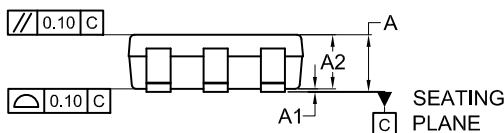

FRONT VIEW



DETAIL A

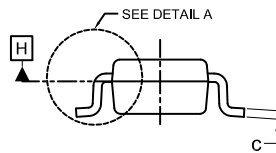

SIDE VIEW

SYMM
⌀

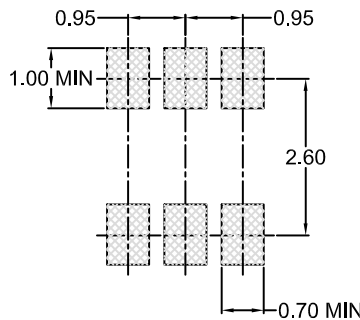

LAND PATTERN
RECOMMENDATION

*FOR ADDITIONAL INFORMATION ON OUR Pb-FREE STRATEGY AND SOLDERING DETAILS, PLEASE DOWNLOAD THE ON SEMICONDUCTOR SOLDERING AND MOUNTING TECHNIQUES REFERENCE MANUAL, SOLDERRM/D.

NOTES:

1. DIMENSIONING AND TOLERANCING PER ASME Y14.5M, 2009.
2. CONTROLLING DIMENSION: MILLIMETERS
3. DIMENSIONS D AND E1 DO NOT INCLUDE MOLD FLASH, PROTRUSIONS, OR GATE BURRS. MOLD FLASH, PROTRUSIONS OR GATE BURRS SHALL NOT EXCEED 0.25MM PER END. DIMENSIONS D AND E1 ARE DETERMINED AT DATUM H.
4. SEATING PLANE IS DEFINED BY THE TERMINALS. "A1" IS DEFINED AS THE DISTANCE FROM THE SEATING PLANE TO THE LOWEST POINT ON THE PACKAGE BODY.

DIM	MILLIMETERS		
	MIN.	NOM.	MAX.
A	0.90	1.00	1.10
A1	0.00	0.05	0.10
A2	0.70	0.85	1.00
A3	0.25 BSC		
b	0.25	0.38	0.50
c	0.10	0.18	0.26
D	2.80	2.95	3.10
d	0.30 REF		
E	2.50	2.75	3.00
E1	1.30	1.50	1.70
e	0.95 BSC		
e1	1.90 BSC		
L1	0.60 REF		
L2	0.20	0.40	0.60
⌀	0°	--	10°

GENERIC MARKING DIAGRAM*

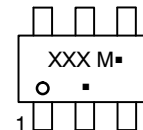

XXX = Specific Device Code
M = Date Code
▪ = Pb-Free Package

(Note: Microdot may be in either location)

*This information is generic. Please refer to device data sheet for actual part marking. Pb-Free indicator, "G" or microdot "▪", may or may not be present. Some products may not follow the Generic Marking.

DOCUMENT NUMBER:	98AON83292G	Electronic versions are uncontrolled except when accessed directly from the Document Repository. Printed versions are uncontrolled except when stamped "CONTROLLED COPY" in red.
DESCRIPTION:	TSOT23 6-Lead	PAGE 1 OF 1

ON Semiconductor and ON are trademarks of Semiconductor Components Industries, LLC dba ON Semiconductor or its subsidiaries in the United States and/or other countries. ON Semiconductor reserves the right to make changes without further notice to any products herein. ON Semiconductor makes no warranty, representation or guarantee regarding the suitability of its products for any particular purpose, nor does ON Semiconductor assume any liability arising out of the application or use of any product or circuit, and specifically disclaims any and all liability, including without limitation special, consequential or incidental damages. ON Semiconductor does not convey any license under its patent rights nor the rights of others.

ON Semiconductor and  are trademarks of Semiconductor Components Industries, LLC dba ON Semiconductor or its subsidiaries in the United States and/or other countries. ON Semiconductor owns the rights to a number of patents, trademarks, copyrights, trade secrets, and other intellectual property. A listing of ON Semiconductor's product/patent coverage may be accessed at www.onsemi.com/site/pdf/Patent-Marking.pdf. ON Semiconductor reserves the right to make changes without further notice to any products herein. ON Semiconductor makes no warranty, representation or guarantee regarding the suitability of its products for any particular purpose, nor does ON Semiconductor assume any liability arising out of the application or use of any product or circuit, and specifically disclaims any and all liability, including without limitation special, consequential or incidental damages. Buyer is responsible for its products and applications using ON Semiconductor products, including compliance with all laws, regulations and safety requirements or standards, regardless of any support or applications information provided by ON Semiconductor. "Typical" parameters which may be provided in ON Semiconductor data sheets and/or specifications can and do vary in different applications and actual performance may vary over time. All operating parameters, including "Typicals" must be validated for each customer application by customer's technical experts. ON Semiconductor does not convey any license under its patent rights nor the rights of others. ON Semiconductor products are not designed, intended, or authorized for use as a critical component in life support systems or any FDA Class 3 medical devices or medical devices with a same or similar classification in a foreign jurisdiction or any devices intended for implantation in the human body. Should Buyer purchase or use ON Semiconductor products for any such unintended or unauthorized application, Buyer shall indemnify and hold ON Semiconductor and its officers, employees, subsidiaries, affiliates, and distributors harmless against all claims, costs, damages, and expenses, and reasonable attorney fees arising out of, directly or indirectly, any claim of personal injury or death associated with such unintended or unauthorized use, even if such claim alleges that ON Semiconductor was negligent regarding the design or manufacture of the part. ON Semiconductor is an Equal Opportunity/Affirmative Action Employer. This literature is subject to all applicable copyright laws and is not for resale in any manner.

PUBLICATION ORDERING INFORMATION

LITERATURE FULFILLMENT:

Email Requests to: orderlit@onsemi.com

ON Semiconductor Website: www.onsemi.com

TECHNICAL SUPPORT

North American Technical Support:
Voice Mail: 1 800-282-9855 Toll Free USA/Canada
Phone: 011 421 33 790 2910

Europe, Middle East and Africa Technical Support:

Phone: 00421 33 790 2910

For additional information, please contact your local Sales Representative