

LV88561, LV88562, LV88563, LV88564

Motor Driver, Single-Phase, PWM, Full-Wave, 24 V/48 V BLDC Motor



ON Semiconductor®

www.onsemi.com

Overview

The LV88561JA/R, LV88562JA/R, LV88563JA/R and LV88564JA/R are the pre-driver for a single-phase 24 V/48 V BLDC motor, which have the closed loop controller for motor rotation speed. These are available to control a motor with low vibration and the low noise. In addition, lead-angle adjustment is possible by external pins. Lead-angle value and lead-angle slant can be adjusted independently. Thus, the device can be driven by high efficiency and low noise with various motors. Motor speed setting curve is adjustable with using external resistor only. As a method of the rotary speed control of the motor, direct-PWM pulse input is adopted.

Features

- Single-phase Full Wave Drive Pre-driver Include Closed Loop Speed Control which is Fitting for High Voltage (24 V/48 V) Application
- Speed Control Function by PWM Duty Input (25 Hz to 100 kHz)
- Soft Start-up Function and PWM Soft Switching Phase Transition
- Soft PWM Duty Cycle Transitions
- Built-in Current Limit Circuit and Thermal Protection Circuit
- Built-in Locked Rotor Protection and Auto Recovery Circuit
- Dynamic Lead Angle Adjustment with Respect to Rotational Speed
- Lead-angle Control Parameters can be Configured
- Lineup of Different Closed Loop Gain Selection
- Lineup of Rotation Signal Output Selection
- These are Pb-Free and Halogen-Free Devices

Typical Applications

- PC & Computing Equipment
- Refrigerator
- Games

LV88561, 562, 563, 564 COMPARISON TABLE

	Loop Gain	Rotation Signal
LV88561JA/R	Normal	FG
LV88562JA/R	Normal	RD
LV88563JA/R	Low	FG
LV88564JA/R	Low	RD

MARKING DIAGRAMS

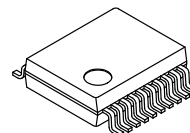

SSOP20J
CASE 565AP

(LV88561JA, LV88562JA, LV88563JA, LV88564JA)

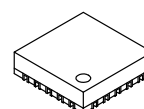
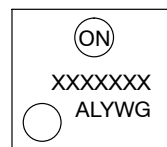

VCT20
CASE 601AB

(LV88561R, LV88562R, LV88563R, LV88564R)

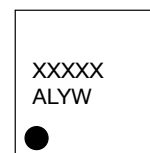

XX = Specific Device Code
A = Assembly Site (OSPI Tarlac Site Code: MP)
L = Wafer Lot Number
YW = Assembly Start Week
G = Pb-Free Package

ORDERING INFORMATION

Device	Package	Shipping†
LV88561JA-AH LV88562JA-AH LV88563JA-AH LV88564JA-AH	SSOP20J (Pb-Free / Halogen Free)	2000 / Tape & Reel
LV88561RTXG LV88562RTXG LV88563RTXG LV88564RTXG	VCT20 (Pb-Free / Halogen Free)	2000 / Tape & Reel

†For information on tape and reel specifications, including part orientation and tape sizes, please refer to our Tape and Reel Packaging Specification Brochure, BRD8011/D.

BLOCK DIAGRAM

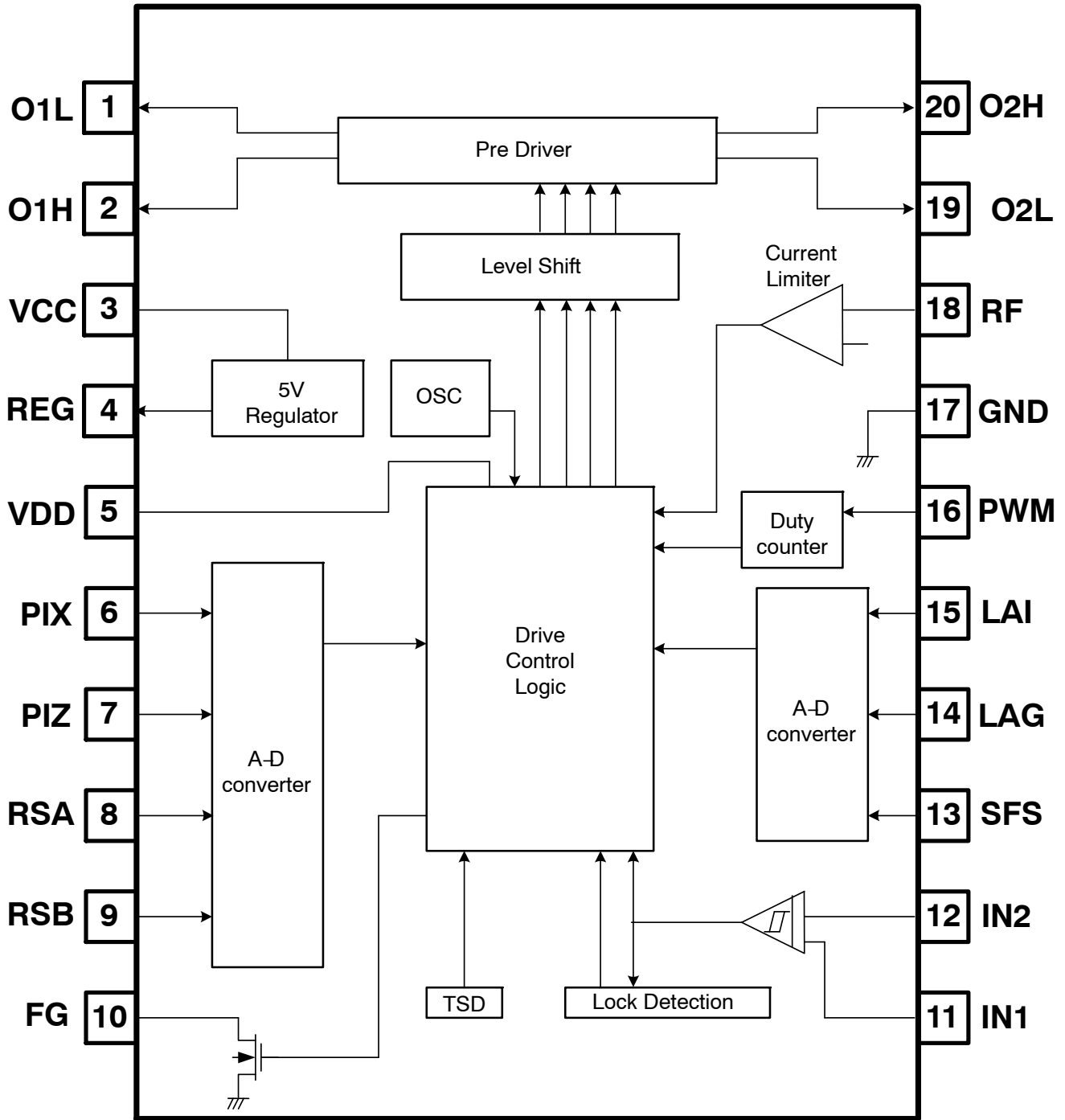

Figure 1. LV88561JA, LV88562JA, LV88563JA, LV88564JA Block Diagram

LV88561, LV88562, LV88563, LV88564

APPLICATION CIRCUIT DIAGRAM



Figure 2. Single-phase BLDC Motor Drive with LV88561JA, LV88562JA, LV88563JA, LV88564JA

LV88561, LV88562, LV88563, LV88564

Table 1. EXAMPLE COMPONENT VALUE

Device	Value	Device	Value
MP1+MN1	FW389	R14	100 Ω
MP2+MN2	FW389	R15	100 Ω
MN3,4	MCH3486	R16	100 Ω
QN1	NMBTA05LT1G	R17	100 Ω
DZ1	MM3Z12VT1G(12V Zener)	R18	*
		R19	*
R0	0.051 Ω // 0.051 Ω	R20	*
R1	0 to 50 kΩ	R21	*
R2	0 to 50 kΩ	R22	5.1 kΩ
R3	0 to 50 kΩ		
R4	0 to 50 kΩ		
R5	0 to 50 kΩ	C0	4.7 μF –10 uF
R6	0 to 50 kΩ	C1	0.1 μF – 1 μF
R7	0 to 50 kΩ	C2	0.1 μF – 1 μF
R8	0 to 50 kΩ	C3	**
R9	2.2 kΩ	C4	0 to 1500 pF
R10	0 to 50 kΩ	C5	0 to 1500 pF
R11	0 to 50 kΩ	C6	0 to 1500 pF
R12	0 to 50 kΩ	C7	0 to 1500 pF
R13	0 Ω	C8	0 to 0.1 μF

*Depend on the user circuit, MP1, MP2, MN1 and MN2.

**Depends on the user environment.

Table 2. TRUTH TABLE

Operating State	IN1	IN2	Inner-PWM State*	O1H	O1L	O2H	O2L	FG
Rotation – drive mode	L	H	On	L	H	H	L	OFF
	H	L		H	L	L	H	L
Rotation – regeneration mode	L	H	Off	L	L	H	L	OFF
	H	L		H	L	L	L	L
Lock protector	L	H	-	L	L	L	L	OFF
	H	L		L	L	L	L	L

*Inner PWM state means the OUTPUT active period decided by inner control logic. Don't match with PWM-pin input signal.

LV88561, LV88562, LV88563, LV88564

PIN ASSIGNMENT

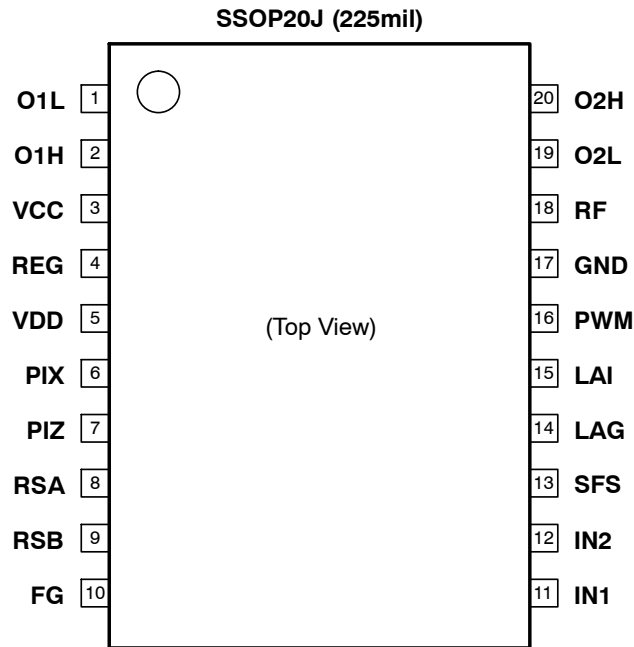

Figure 3. LV88561JA, LV88562JA, LV88563JA, LV88564JA Pin Assignment

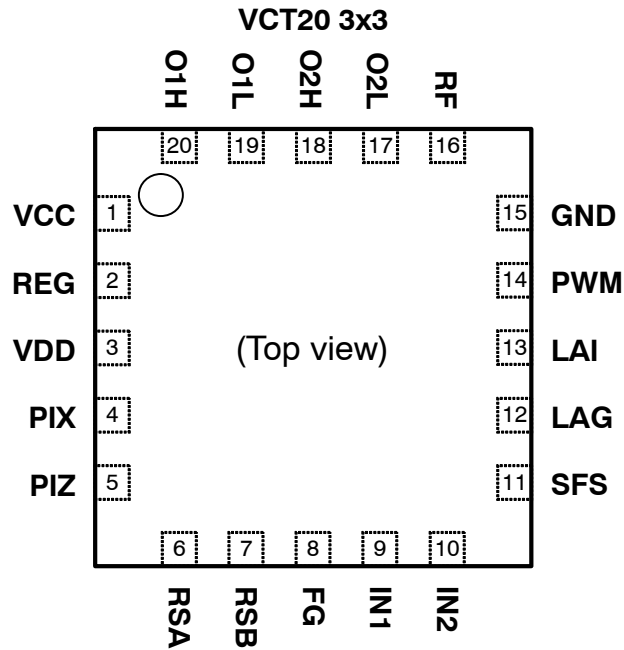

Figure 4. LV88561R, LV88562R, LV88563R, LV88564R Pin Assignment

LV88561, LV88562, LV88563, LV88564

Table 3. PIN FUNCTION DESCRIPTION (Pin No. – SSOP20J version)

Pin No.	Pin name	Function
1 19	O1L O2L	Output pins of the low-side gate-drive signal. (See "Truth Table" on page 4 for the polarity)
2 20	O1H O2H	Output pins of the high-side gate-drive signal. (See "Truth Table" on page 4 for the polarity)
3	VCC	Power supply pin. The input voltage to this pin must be stabilized without the influence of the noise, ripple, and etc. Therefore, it is necessary to connect the capacitor near VCC pin and GND pin as much as possible.
4	REG	Output pin of the regulated voltage (5.0 V). It is necessary to connect the capacitor near this pin and GND pin for stabilizing this regulated voltage.
5	VDD	Logic circuit power supply pin. This pin should be shorted to REG pin.
6 7	PIX PIZ	PWM input duty adjust pins at the point of maximum or minimum rotation speed.
8 9	RSA RSB	Maximum or minimum rotation speed adjust pins.
10	FG	Output pin of the rotational signal. For LV88561 and LV88563, it functions as FG (Frequency Generator) and for LV88562 and LV88564, it functions as RD (Rotation Detection). This pin should be opened (disconnected) when not in use.
11 12	IN1 IN2	Hall signal input pins.
13	SFS	Soft start adjust pin.
14	LAG	Lead angle gradient adjust pin.
15	LAI	Initial lead angle adjust pin in minimum rotation speed.
16	PWM	PWM input pin of the speed control signal as the rectangular wave.
17	GND	GND pin.
18	RF	Output current detect pin. When the voltage level at this pin exceeds the internal set detection level, outputs turn to the regenerating mode.

LV88561, LV88562, LV88563, LV88564

Table 4. MAXIMUM RATINGS

Parameter	Symbol	Conditions	Ratings	Unit
Maximum supply voltage	VCC _{max}	VCC pin	20	V
Maximum output voltage	VOUT _{max}	O1H/O1L/ O2H/O2L pin	20	V
Maximum output current	IOUT _{max}	O1H/O1L/ O2H/O2L pin	50	mA
Maximum output peak current (Note 1)	IOUT _{peak}	O1H/O1L/ O2H/O2L pin	150	mA
REG pin maximum output current	I _{REGmax}	REG pin	20	mA
RSA/RSB/PIX/PIZ/LAI/LAG/SFS/IN1/IN2/RF pin maximum input voltage	VIN _{max}	RSA/RSB/PIX/ PIZ/LAI/LAG/IN1/ IN2/SFS/RF pin	5.5	V
PWM pin maximum input voltage	VPWM _{max}	PWM pin	5.5	V
FG pin withstanding voltage	VFG _{max}	FG pin	20	V
FG pin maximum output current	IFG _{max}	FG pin	10	mA
Allowable power dissipation (Note 2)	Pd _{max}	LV8856xJA	0.8	W
Allowable power dissipation (Note 3)	Pd _{max}	LV8856xR	1.0	W
Operating temperature	T _{opr}		-40 to +105	°C
Storage temperature	T _{stg}		-55 to +150	°C
Maximum junction temperature	T _{jmax}		150	°C
Moisture Sensitivity Level (MSL) (Note 4)	MSL	LV8856xJA	3	-
Moisture Sensitivity Level (MSL) (Note 4)	MSL	LV8856xR	1	-
Lead Temperature Soldering Pb-Free Versions (30s or less) (Note 5)	T _{SLD}		255	°C
ESD Human body Model : HBM (Note 6)	ESD _{HBM}		±2000	V

Stresses exceeding those listed in the Maximum Ratings table may damage the device. If any of these limits are exceeded, device functionality should not be assumed, damage may occur and reliability may be affected.

1. IOUT_{peak} is the peak value of the motor supply current with duty_cycle < 5%.
2. Specified circuit board : 114.3 mm x 76.1 mm x 1.6 mm, glass epoxy single layer board. It has 1 oz internal power and ground planes and 1/2 oz copper traces. Please refer to Thermal Test Conditions on page 23.
3. Specified circuit board : 50.0 mm x 40.0 mm x 0.8 mm, glass epoxy 4-layer board. It has 1 oz internal power and ground planes and 1/2 oz copper traces on top and bottom of the board. Please refer to Thermal Test Conditions on page 23.
4. Moisture Sensitivity Level (MSL): IPC/JEDEC standard: J-STD-020A
5. For information, please refer to our Soldering and Mounting Techniques Reference Manual, SOLDERRM/D http://www.onsemi.com/pub_link/Collateral/SOLDERRM-D.PDF
6. ESD Human Body Model is based on JEDEC standard: JESD22-A114

Table 5. THERMAL CHARACTERISTICS

Parameter	Symbol	Value	Unit
Thermal Resistance, Junction-to-Ambient (Note 7) LV8856xJA	R _{θJA}	156	°C/W
Thermal Resistance, Junction-to-Ambient (Note 8) LV8856xR	R _{θJA}	125	°C/W

7. Specified circuit board : 114.3 mm x 76.1 mm x 1.6 mm, glass epoxy single layer board. It has 1 oz internal power and ground planes and 1/2 oz copper traces on top and bottom of the board. Please refer to Thermal Test Conditions on page 23.
8. Specified circuit board : 50.0 mm x 40.0 mm x 0.8 mm, glass epoxy 4-layer board. It has 1 oz internal power and ground planes and 1/2 oz copper traces on top and bottom of the board. Please refer to Thermal Test Conditions on page 23.

LV88561, LV88562, LV88563, LV88564

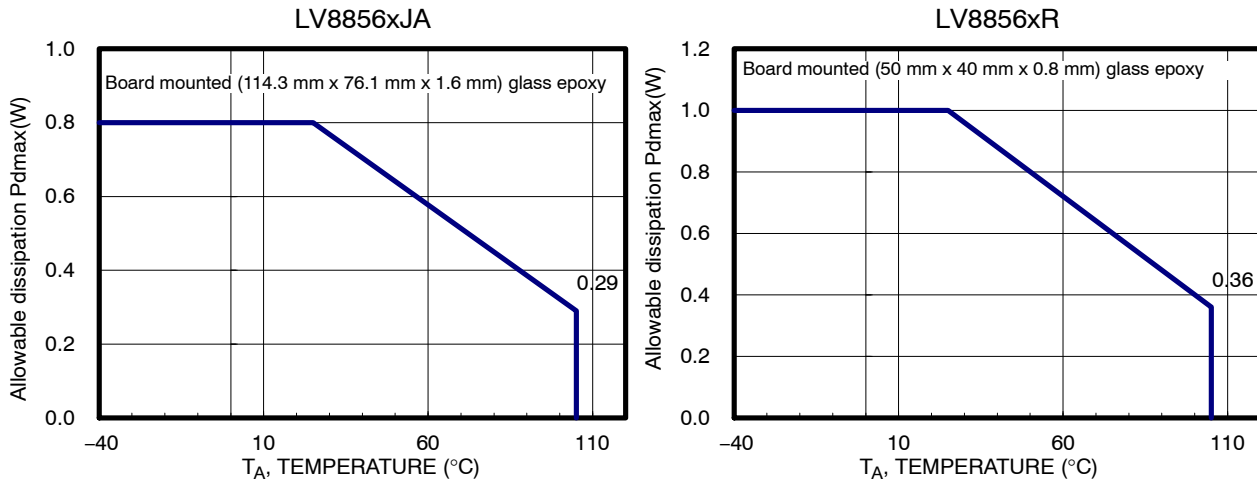

Figure 5. Power Dissipation vs Ambient Temperature Characteristic

Table 6. RECOMMENDED OPERATING RANGES (Note 9)

Parameter	Symbol	Conditions	Ratings	Unit
VCC supply voltage	VCC _{typ}	VCC pin	12	V
VCC operating supply voltage range1	VCC _{op1}	VCC pin	6.0 to 16	V
VCC operating supply voltage range2 (Note 10)	VCC _{op2}	VCC pin	3.9 to 6.0	V
PWM input frequency range	F _{pwm}	PWM pin	25 to 100k	Hz
PWM minimum input low/high pulse width	T _{wpwm}	PWM pin	100	ns
IN1 input voltage range	V _{in1}	IN1 pin	0 to VREG	V
IN2 input voltage range	V _{in2}	IN2 pin	0.3 to 0.55*VREG	V
Control input voltage range	V _{cnth}	RSA/RSB/PIX/ PIZ/LAI/LAG/SFS pin	0 to VREG	V

9. Functional operation above the stresses listed in the Recommended Operating Ranges is not implied. Extended exposure to stresses beyond the Recommended Operating Ranges limits may affect device reliability.

10. When the VCC voltage below 6.0 V, motor rotation function keep to normally until to 3.9 V. But there are possibility that the ELECTRICAL CHARACTERISTICS is varied.

LV88561, LV88562, LV88563, LV88564

Table 7. ELECTRICAL CHARACTERISTICS at TA = 25°C, VCC_{OP} = 12 V unless otherwise noted. (Note 11)

Parameter	Symbol	Conditions	Ratings			Unit
			Min	Typ	Max	
Circuit current	ICC			9	16	mA
O1H/O1L/O2H/O2L High-side on-resistance	ROHon	IO = 10 mA		30	80	Ω
O1H/O1L/O2H/O2L Low-side on-resistance	ROLon	IO = 10 mA		30	80	Ω
O1H/O1L/O2H/O2L PWM output frequency	fpwmo		45.6	48	50.4	kHz
PWM pin low level input voltage	Vpwml		0		0.7	V
PWM pin high level input voltage	Vpwmh		2.8		5.5	V
PWM input resolution	Δpwm			8		Bit
FG pin low level output voltage	Vfgl	IFG = 5 mA		0.2	0.3	V
FG pin leak current	Ifglk	VCC = 16 V VFG = 16 V			1	μA
REG pin output voltage	VREG		4.7	5.0	5.3	V
Lock-detection time1 (Note 12)	Tld1	Under rotation	0.27	0.3	0.33	S
Lock-detection time2 (Note 13)	Tld2	Start-up	0.63	0.7	0.77	S
Lock-Stop release time1 from 1 st to 4 th off time	Tlroff1		3.1	3.5	3.9	S
Lock-Restart on time	Tlron		0.63	0.7	0.77	S
Lock-Restart time ratio1	Rlr1	Tlroff1/Tlron		5		-
Lock-Stop release time2(Note 14) as from 5 th off time	Tlroff2		12.5	14	15.5	S
Lock-Restart time ratio2(Note 14) as from 5 th off time	Rlr2	Tlroff2/Tlron		20		-
Thermal protection detection temperature	Tthp	(Design target)	150	180		°C
Thermal protection detection hysteresis	ΔTthp	(Design target)		40		°C
Current limit detection voltage	VTHCLM	RF-GND	0.09	0.10	0.11	V
REG pin output voltage load regulation	ΔVregld	I _{REG} = -10 mA		20	50	mV
Hall input bias current	I _{hin}	IN1, IN2 = 0 V		0	1	μA
Hall input sensitivity	ΔV _{hin}		40			mV
Control input bias current	I _{ctlin}	PIX, PIZ, RSA, RSB, SFS, LAG, LAI = 0 V		0	1	μA
PWM input bias current	I _{pwm}	VDD = 5.5 V, PWM = 0 V	14	28	42	μA
UVLO detection voltage	V _{uvdet}	VCC voltage	3.1	3.4	3.6	V
UVLO release voltage	V _{uvrls}	VCC voltage	3.3	3.6	3.9	V
UVLO hysteresis voltage	ΔV _{uv}		0.1	0.2	0.4	V

11. Product parametric performance is indicated in the Electrical Characteristics for the listed test conditions, unless otherwise noted. Product performance may not be indicated by the Electrical Characteristics if operated under different conditions.

12. When the motor rotate state and the motor rotation speed reach to below 50 rpm (phase change period over 0.3s), lock protection function will activate.

13. At the motor start-up timing, the motor can't rotate until 0.7s, lock protection function work.

14. When the locked rotor state is continued for a long time, lock stop period will change from 5th off time.

TYPICAL CHARACTERISTICS



Figure 6. Typical Characteristics

EQUIVALENT CIRCUIT



Figure 7. O1L, O1H, O2L and O2H Equivalent Circuit

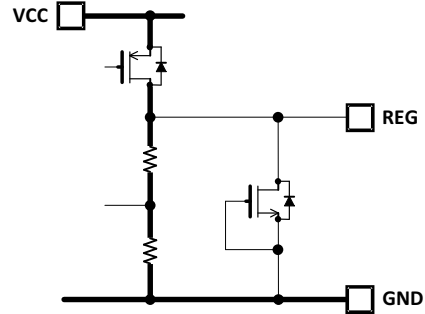

Figure 8. REG Equivalent Circuit

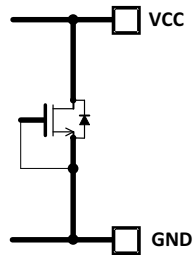

Figure 9. VCC Equivalent Circuit

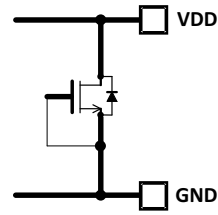

Figure 10. VDD Equivalent Circuit



Figure 11. IN1, IN2 Equivalent Circuit

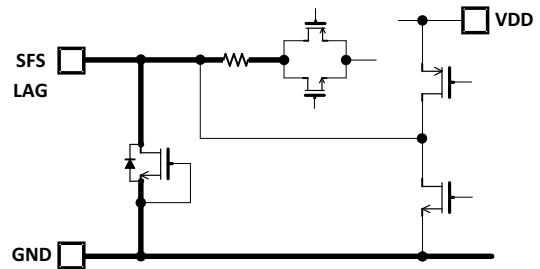

Figure 12. SFS, LAG Equivalent Circuit

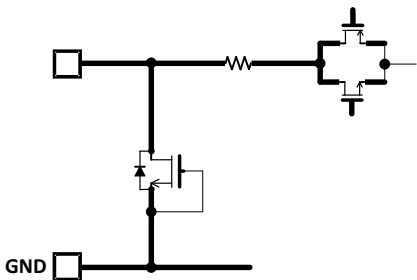

Figure 13. LAI Equivalent Circuit

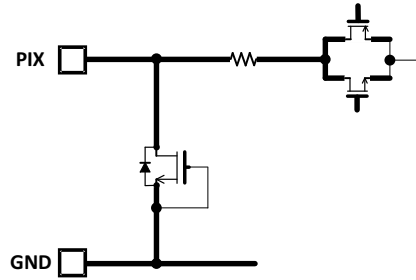

Figure 14. PIX, PIZ Equivalent Circuit



Figure 15. RSA, RSB Equivalent Circuit



Figure 16. FG Equivalent Circuit



Figure 17. PWM Equivalent Circuit

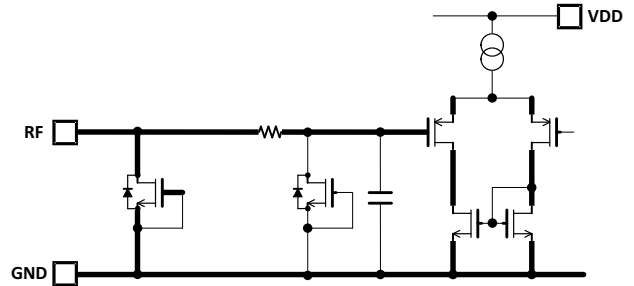

Figure 18. RF Equivalent Circuit

STATE DIAGRAM

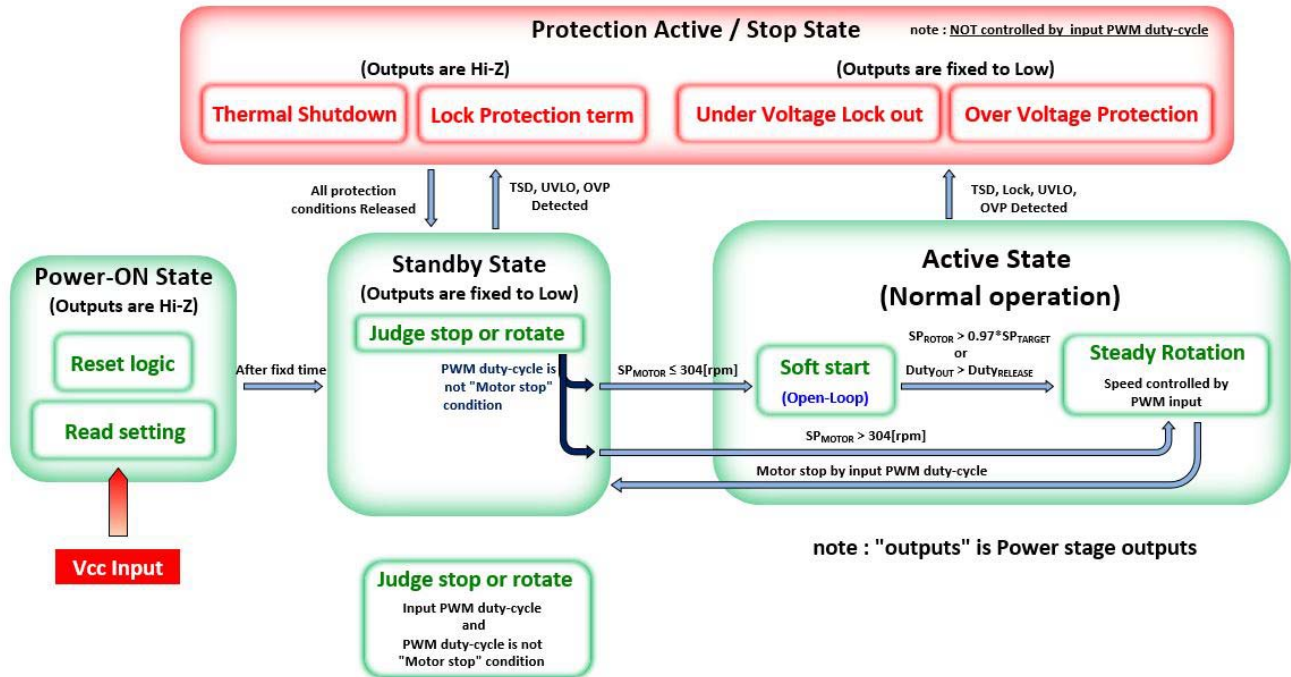

Figure 19. State Diagram

FUNCTIONAL DESCRIPTION**Loop Gain**

Motor speed loop gain of LV88563 and LV88564 is lower than that of LV88561 and LV88562. If the motor coil current generate large overshoot during motor speed transition, LV88563 and LV88564 can reduce the overshooting current but the motor rotation response speed will decrease. LV88561 and LV88562 are recommended if faster response speed is required.

Current Sense Resistor Pin (RF)

RF is current sense input terminal.

Voltage across the sense resistor represents the motor current and is compared against the internal $V_{TH_{OVC}}$ (0.10 Vtyp.) for setting the over-current limiter (CLM).

VCC and GND Pin (VCC ,GND)

Since Power FET side ground line has to tolerate surge of current, separate it from the GND pin as far away as possible and connect it point-to-point to the ground side of the capacitor (C0) between VCC and GND.

Internal 5.0 V Voltage Regulator Pin (REG, VDD)

REG is internal 5.0 V voltage regulator.

VDD is power supply for internal logic, oscillator, and protection circuits. Please connect REG and VDD.

When PIX, PIZ, RSA, RSB, LAI, LAG and SFS are used, it is recommended that application circuits are made using this output. The maximum load current of REG is 20 mA. Don't exceed this value. Place capacity from 0.1 μ F to 1.0 μ F in the close this pin.

Rotational Signal Pin (FG)

This is an open drain output pin which outputs the rotational signal. In case of LV88561 and LV88563, FG signal will come out from this pin and its frequency will represent electrical speed of a motor.

In case of LV88562 and LV88564, RD signal will come out from this pin. See page 21 "Lock detection and Lock protection" for more information about the RD signal.

Recommended pull up resistor value is 1 k Ω to 100 k Ω . Leave the pin open when not in use.

Output Pins for External FET Control (O1H , O1L , O2H, O2L)

These pins are output for external MOSFET. O1H and O2H connect to upper side P-ch FET's gate-line. O1L and O2L connect to lower side N-ch FET's gate line.

Hall-Sensor Input Pins (IN1, IN2)

Differential output signals of the hall sensor are to be interfaced at IN1 and IN2. It is recommended that 0.01 μ F capacitor is connected between both pins to filter system noise.

When a Hall IC is used, the output of the Hall IC must be connected to the pin IN1. And, the pin IN2 must be kept in the middle level of the Hall IC power supply voltage.

Command Input (PWM)

This pin reads the duty cycle of the PWM pulse and controls rotational speed. The PWM input signal level is supported from 2.5 V to 5 V. The combination with the rotational speed control by DC voltage, is impossible.

When the pin is not used, it must be connected to ground. The minimum pulse width is 100 ns.

Lead-Angle Setting Pin (LAI, LAG)

LV8856xJA/R provides the dynamic lead angle adjustment. To match the motor characteristics, set two point lead-angle, low speed side (set by LAI pin) and high speed side(set by LAG pin).

At middle range of input duty, the lead-angle is applied to calculated value for relative relationship.

The DC voltage levels applied to these pins are converted to the lead angle parameter. The voltages are fetched right after the power-on-reset. Because the internal conversion circuit works inside REG power rail, it is recommended that the LAI and LAG voltages are made from V_{REG} .

Rotation Speed Setting Pin (RSA, RSB)

LV8856xJA/R provides the feedback speed control, so this device can set the rotation speed value (RPM) directly.

To make the motor speed setting curve, set two point rotation speed value, high speed side and low speed side.

The DC voltage levels applied to these pins are converted to the rotation speed parameter. The voltages are fetched right after the power-on-reset. Because the internal conversion circuit works inside REG power rail, it is recommended that the RSA and RSB voltages are made from V_{REG} .

Rotation Speed Curve Duty Setting Pin (PIX, PIZ)

To make the motor speed setting curve, set two point input duty parameter, high speed side and low speed side.

The DC voltage levels applied to these pins are converted to the input duty parameter. The voltages are fetched right after the power-on-reset. Because the internal conversion circuit works inside REG power rail, it is recommended that the PIX and PIZ voltages are made from V_{REG} .

Soft-Start and Dead Time Setting Pin (SFS)

LV8856xJA/R provides synchronous rectification drive for high efficiency drive. External FET size is variable caused by the motor application. So this driver IC is able to choose 2 types of dead time.

Soft start function pattern is able to choose from 16 types.

The DC voltage levels applied to these pins are converted to the soft-start setting and dead time parameter. The voltage is fetched right after the power-on-reset. Because the internal conversion circuit works inside REG power rail, it is recommended that the SFS voltage is made from V_{REG} .

DETAILED DESCRIPTION

As for all numerical value used in this description, the design value or the typical value is used.

Rotation Speed Curve Setting Description

The LV8856xJA/R can set 2 points speed parameter arbitrarily.

Low speed point (LSP)

High speed point (HSP)

At middle range of input duty, the rotation speed is applied to calculated value for relative relationship.

When the input duty is lower than LSP setting duty, the LV8856xJA/R can select “motor stop” or “keep LSP rotation speed”.

When the input duty is higher than HSP setting duty, the LV8856xJA/R can select “free run” or “keep HSP rotation speed”.

Rotation speed of LSP and HSP is set by RSA and RSB pin. The case of $RSA > RSB$, “motor stop” mode applied. The case of $RSA < RSB$, “keep LSP rotation speed” mode applied.

Input duty of LSP and HSP is set by PIX and PIZ pin. The case of $PIX > PIZ$, “free run” mode applied. The case of $PIX < PIZ$, “keep HSP rotation speed” mode applied.

So LV8856xJA/R can't set decrease speed curve at input duty increase.

Figures 21 – 24 show setting curve example.



Figure 20. Image of Speed Setting Curve



Figure 21. Speed Setting Curve Type Example 1
Minimum Speed Set and Maximum Speed Set



Figure 22. Speed Setting Curve Type Example 2
Motor Stop Mode and Maximum Speed Set



Figure 23. Speed Setting Curve Type Example 3
Motor Stop Mode and Free Run Mode



Figure 24. Speed Setting Curve Type Example 4
Minimum Speed Set and Free Run Mode

LV88561, LV88562, LV88563, LV88564

Table 8. ROTATION SPEED SETTING TABLE FOR RSA/RSB PIN

A-D code	RPM	A-D code	RPM	A-D code	RPM	A-D code	RPM	A-D code	RPM	A-D code	RPM	A-D code	RPM	A-D code	RPM
0	0	64	980	128	2180	192	4800	256	10800	320	17200	384	23600	448	30000
1	0	65	990	129	2200	193	4850	257	10900	321	17300	385	23700	449	30100
2	0	66	1000	130	2220	194	4900	258	11000	322	17400	386	23800	450	30200
3	0	67	1010	131	2240	195	4950	259	11100	323	17500	387	23900	451	30300
4	0	68	1020	132	2260	196	5000	260	11200	324	17600	388	24000	452	30400
5	0	69	1030	133	2280	197	5050	261	11300	325	17700	389	24100	453	30500
6	400	70	1040	134	2300	198	5100	262	11400	326	17800	390	24200	454	30600
7	410	71	1050	135	2320	199	5150	263	11500	327	17900	391	24300	455	30700
8	420	72	1060	136	2340	200	5200	264	11600	328	18000	392	24400	456	30800
9	430	73	1080	137	2360	201	5300	265	11700	329	18100	393	24500	457	30900
10	440	74	1100	138	2380	202	5400	266	11800	330	18200	394	24600	458	31000
11	450	75	1120	139	2400	203	5500	267	11900	331	18300	395	24700	459	31100
12	460	76	1140	140	2420	204	5600	268	12000	332	18400	396	24800	460	31200
13	470	77	1160	141	2440	205	5700	269	12100	333	18500	397	24900	461	31300
14	480	78	1180	142	2460	206	5800	270	12200	334	18600	398	25000	462	31400
15	490	79	1200	143	2480	207	5900	271	12300	335	18700	399	25100	463	31500
16	500	80	1220	144	2500	208	6000	272	12400	336	18800	400	25200	464	31600
17	510	81	1240	145	2520	209	6100	273	12500	337	18900	401	25300	465	31700
18	520	82	1260	146	2540	210	6200	274	12600	338	19000	402	25400	466	31800
19	530	83	1280	147	2560	211	6300	275	12700	339	19100	403	25500	467	31900
20	540	84	1300	148	2600	212	6400	276	12800	340	19200	404	25600	468	32000
21	550	85	1320	149	2650	213	6500	277	12900	341	19300	405	25700	469	32100
22	560	86	1340	150	2700	214	6600	278	13000	342	19400	406	25800	470	32200
23	570	87	1360	151	2750	215	6700	279	13100	343	19500	407	25900	471	32300
24	580	88	1380	152	2800	216	6800	280	13200	344	19600	408	26000	472	32400
25	590	89	1400	153	2850	217	6900	281	13300	345	19700	409	26100	473	32500
26	600	90	1420	154	2900	218	7000	282	13400	346	19800	410	26200	474	32600
27	610	91	1440	155	2950	219	7100	283	13500	347	19900	411	26300	475	32700
28	620	92	1460	156	3000	220	7200	284	13600	348	20000	412	26400	476	32800
29	630	93	1480	157	3050	221	7300	285	13700	349	20100	413	26500	477	32900
30	640	94	1500	158	3100	222	7400	286	13800	350	20200	414	26600	478	33000
31	650	95	1520	159	3150	223	7500	287	13900	351	20300	415	26700	479	33100
32	660	96	1540	160	3200	224	7600	288	14000	352	20400	416	26800	480	33200
33	670	97	1560	161	3250	225	7700	289	14100	353	20500	417	26900	481	33300
34	680	98	1580	162	3300	226	7800	290	14200	354	20600	418	27000	482	33400
35	690	99	1600	163	3350	227	7900	291	14300	355	20700	419	27100	483	33500
36	700	100	1620	164	3400	228	8000	292	14400	356	20800	420	27200	484	33600
37	710	101	1640	165	3450	229	8100	293	14500	357	20900	421	27300	485	33700
38	720	102	1660	166	3500	230	8200	294	14600	358	21000	422	27400	486	33800
39	730	103	1680	167	3550	231	8300	295	14700	359	21100	423	27500	487	33900
40	740	104	1700	168	3600	232	8400	296	14800	360	21200	424	27600	488	34000
41	750	105	1720	169	3650	233	8500	297	14900	361	21300	425	27700	489	34100
42	760	106	1740	170	3700	234	8600	298	15000	362	21400	426	27800	490	34200
43	770	107	1760	171	3750	235	8700	299	15100	363	21500	427	27900	491	34300
44	780	108	1780	172	3800	236	8800	300	15200	364	21600	428	28000	492	34400
45	790	109	1800	173	3850	237	8900	301	15300	365	21700	429	28100	493	34500
46	800	110	1820	174	3900	238	9000	302	15400	366	21800	430	28200	494	34600
47	810	111	1840	175	3950	239	9100	303	15500	367	21900	431	28300	495	34700
48	820	112	1860	176	4000	240	9200	304	15600	368	22000	432	28400	496	34800
49	830	113	1880	177	4050	241	9300	305	15700	369	22100	433	28500	497	34900
50	840	114	1900	178	4100	242	9400	306	15800	370	22200	434	28600	498	35000
51	850	115	1920	179	4150	243	9500	307	15900	371	22300	435	28700	499	35100
52	860	116	1940	180	4200	244	9600	308	16000	372	22400	436	28800	500	35200
53	870	117	1960	181	4250	245	9700	309	16100	373	22500	437	28900	501	35300
54	880	118	1980	182	4300	246	9800	310	16200	374	22600	438	29000	502	35400
55	890	119	2000	183	4350	247	9900	311	16300	375	22700	439	29100	503	35500
56	900	120	2020	184	4400	248	10000	312	16400	376	22800	440	29200	504	35600
57	910	121	2040	185	4450	249	10100	313	16500	377	22900	441	29300	505	35700
58	920	122	2060	186	4500	250	10200	314	16600	378	23000	442	29400	506	35800
59	930	123	2080	187	4550	251	10300	315	16700	379	23100	443	29500	507	35900
60	940	124	2100	188	4600	252	10400	316	16800	380	23200	444	29600	508	36000
61	950	125	2120	189	4650	253	10500	317	16900	381	23300	445	29700	509	36000
62	960	126	2140	190	4700	254	10600	318	17000	382	23400	446	29800	510	36000
63	970	127	2160	191	4750	255	10700	319	17100	383	23500	447	29900	511	36000

LV88561, LV88562, LV88563, LV88564

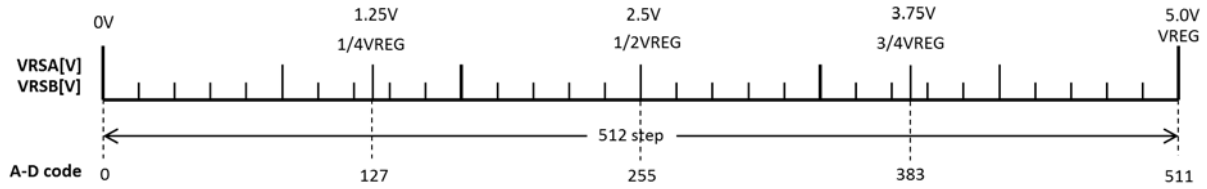

Figure 25. A-D Code Figure for RSA/RSB Pin

Voltage of RSA/RSB is calculated by below formula.

$$VRSA, VRSB[V] = \frac{VREG}{512} \times \text{Target RPM's A_D code} \quad (\text{eq. 1})$$

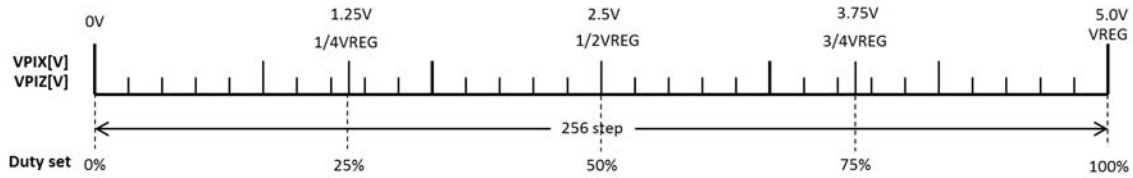

Figure 26. Input Duty Parameter Setting for PIX/PIZ Pin

Voltage of PIX/PIZ is calculated by below formula.

$$VPIX, VPIZ[V] = VREG \times \frac{\text{Target Duty}[\%]}{100} \quad (\text{eq. 2})$$

Lead-angle Setting Description

LV8856xJA/R provides the dynamic lead angle adjustment. To match the motor characteristics, set two points lead-angle amounts. Settable range is -22.225° to $+22.225^\circ$ (0.175° step). LSP's value is set by LAI pin and

HSP's value is set by LAG pin. At middle range of input duty, the lead-angle is applied to calculated value for relative relationship.

LV8856xJA/R can set delay angle setting. Minus value means delay angle.

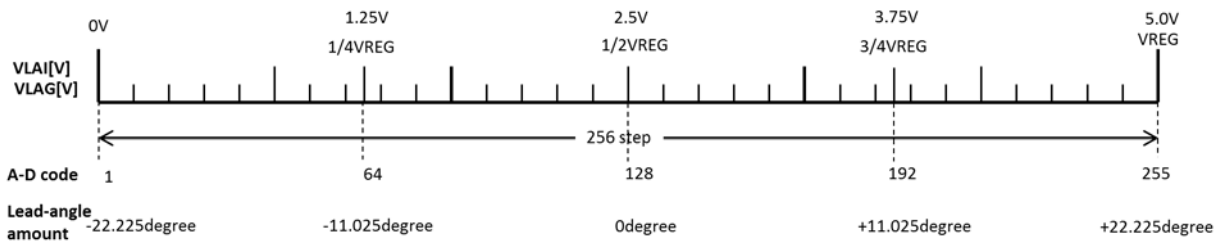

Figure 27. Lead-angle Parameter Setting for LAI/LAG Pin

Voltage of LAI/LAI is calculated by below formula.

$$VLAI, VLAG[V] = \frac{VREG}{2} + VREG \times \frac{\text{Target Lead Angle Value } [^\circ]}{44.45} \quad (\text{eq. 3})$$

Lead angle amounts of LSP and HSP doesn't care each relationship of large/small.



Figure 28. Image of Lead Angle Setting Curve

Lead angle	Low speed	High speed
Image		
Wave form		

Figure 29. Lead Angle Image Waveform

Soft-Start Setting Description

LV8856xJA/R has soft start function.

To avoid the motor rush current, the output PWM duty rise-up from zero slowly at the starting of motor rotation.

The soft start action release conditions are below;

Rotation speed reach to target speed decided by PWM input.

Output duty reach to “Release duty”.

When reached to the release condition, change to closed-loop speed control mode.

If the motor can't rotation during 0.7s (typ), lock protection function will activate.

The recommendation of soft-start time is 1.72 s. Hence, it can be set by A-D code “0” and “31” for easy implementation by pin pull-down or pull-up.

A-D code	Soft-start time(s)	Release duty(%)	Dead time(us)
0	1.72	86	0.5
1	0.03	86	0.5
2	0.86	86	0.5
3	2.58	86	0.5
4	3.44	86	0.5
5	5.16	86	0.5
6	8.6	86	0.5
7	17.2	86	0.5
8	10	20	0.5
9	5	20	0.5
10	3	20	0.5
11	2	20	0.5
12	1.5	20	0.5
13	1	20	0.5
14	0.5	20	0.5
15	0.02	20	0.5
16	0.02	20	1
17	0.5	20	1
18	1	20	1
19	1.5	20	1
20	2	20	1
21	3	20	1
22	5	20	1
23	10	20	1
24	17.2	86	1
25	8.6	86	1
26	5.16	86	1
27	3.44	86	1
28	2.58	86	1
29	0.86	86	1
30	0.03	86	1
31	1.72	86	1

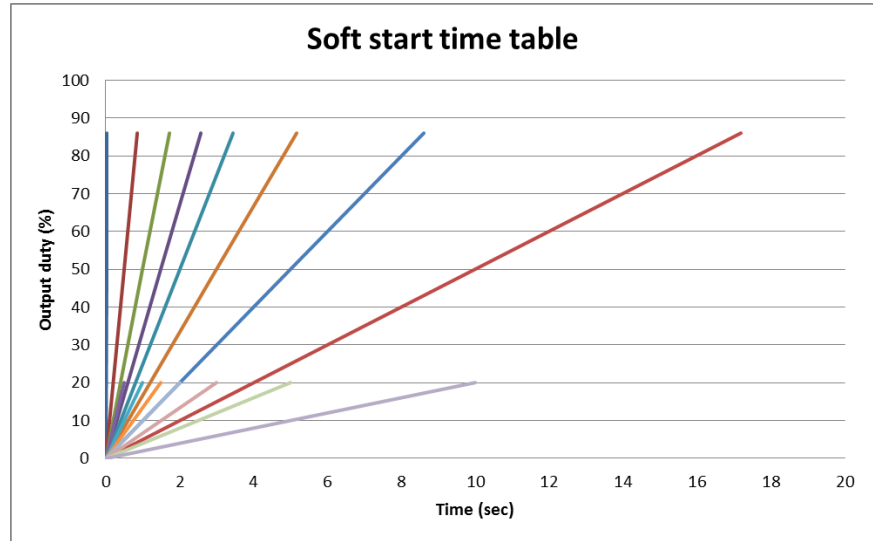

Figure 30. Soft-start and Dead Time Setting Table for SFS Pin

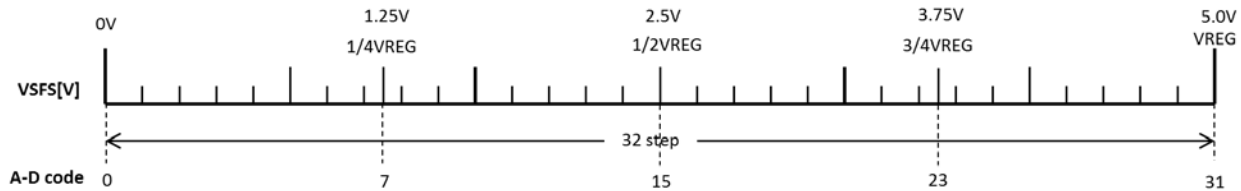

Figure 31. A-D Code Figure for SFS Pin

Voltage of SFS is calculated by below formula.

$$VSFS[V] = \frac{VREG}{32} \times \text{Target Setting's A_D Code} \quad (\text{eq. 4})$$

Output Waveform

LV8856xJA/R output PWM frequency is fixed by the inner oscillator parameter, 48 kHz (typ) which doesn't depend on input PWM frequency.

Driving method of LV8856xJA/R uses PWM soft switching drive.

Soft switching width is changed by input PWM duty.

When the input duty is HSP setting duty, soft switching width is narrow ($S/L = 20.5\%$)

On the other hand when the input duty is LSP setting duty, soft switching width becomes wide ($S/L = 46.9\%$)

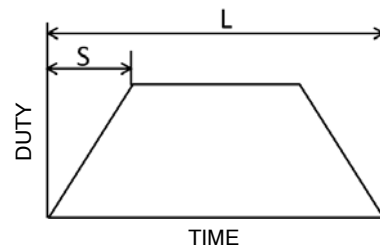

Figure 32. Image of Soft Switching Width

In this part, the rise/fall time of soft switching waveform is equal. Therefore, the "S" in the figure can be also applied to fall time as well.

At the middle range input duty, the soft switching width is applied to calculated value for relative relationship.

Protections

LV8856xJA/R has some protection function.

- Thermal shutdown protection (TSD)
- Under voltage lock out (UVLO)
- Current limiter (CLM)
- Lock protection

When TSD or Lock protection is working, external FETs are all turned off.

On the other hand, when UVLO or CLM is working, output is turned off and goes into re-circulation state.

Thermal Shutdown Protection (TSD)

When this IC’s junction temperature rises to 180°C (typ), O1H/O2H output turns to high, and O1L/O2L output turn to low. External FETs are all turns off and coil current is shut off.

Next, when IC’s junction temperature falls to 140°C (typ), thermal shutdown function is released and motor starts to rotate.

Under Voltage Lock Out (UVLO)

UVLO work voltage: VCC 3.4 V (typ)

UVLO release voltage: VCC 3.6 V (typ)

Current Limiter (CLM)

When the coil current increases and the voltage of the RF pin rises to 0.1 V (typ), the CLM operates and shut the coil current.

CLM current is adjustable by resistor value between RF–GND.

The sense resistor value is calculated as follows.

$$\text{Sense Resistor}[\Omega] = \frac{V_{TH_{CLM}}[V]}{I_{CLM}[A]} \tag{eq. 5}$$

For example, to set the CLM current threshold at 2A, the sense resistor value is

$$\begin{aligned} \text{Sense Resistor} &= \frac{0.10(\text{typ})}{2.0} \\ \text{Res} &= 0.05 [\Omega] \end{aligned} \tag{eq. 6}$$

Lock Detection and Lock Protection

When the motor lock is happened, heat is generated because IC continues to supply electricity to the motor. And IC detects this radiated heat and turns off the electricity to the motor.

If IC does not receive the FG edge for 0.3sec (under 50rpm), the IC judges "motor lock" has occurred and the lock protection function will activate. In this mode, the RD signal goes to "High", though it is "Low" at motor starts.

When the motor restarts and IC detects 4 phase changes, the RD signal goes to "Low".



Figure 33. Image of Lock Detection and Lock Protection

It takes 3.5s for Lock protection time(1st to 4th protection time). This equals to the total of lock detection time and lock protection time. The lock detection time – the ratio is approx. 1:5 (from 1st to 4th protection time).

After 5th protection time, the lock protection time becomes 14s and protection–start time ratio is approx. 1:20 (after 5th protection time)

When the motor rotation is stopped by PWM input signal, the lock detection is reset and the motor starts to rotate smoothly once the IC receives the rotation start instruction.



Figure 34. Image of Lock Protection Time

PCB GUIDELINES**VCC and Ground Routing**

Make sure to short-circuit power line externally by a low impedance route on one side of PCB. As high current flows into external FET to GND, connect it to GND through a low impedance route.

The capacitance connected between the VCC pin and the opposite ground is to stabilize the battery. Make sure to connect an electrolytic capacitor with capacitance value of about 1 μF (0.1 μF or greater) to eliminate low frequency noise. Also, to eliminate high frequency noise, connect a capacitor of superior frequency characteristics, with capacitance value of about 0.1 μF and make sure that the capacitor is connected as close to the pin as possible. Allow enough room in the design so the impact of PWM drive and flyback do not affect other components. Especially, when the coil inductance is large and/or the coil resistance is small, current ripple will rise so it is necessary to use a high-capacity capacitor with superior frequency characteristics. Please note that if the battery voltage rises due to the impact of the coil flyback as a result of the use of diode for preventing the break down caused by reverse connection, it is necessary to either increase the capacitance value or place Zener diode between the battery and the ground so that the voltage does not exceed its absolute maximum voltage.

When the electrolytic capacitor cannot be used, add the resistor with the value of about 1 Ω and a ceramic capacitor with the capacitor value of about 10 μF in series for the alternative use. When the battery line is extended,

(20–30 cm to 2–3 m), the battery voltage may overshoot when the power is supplied due to the impact of the routing of the inductance. Make sure that the voltage does not exceed the absolute maximum standard voltage when the power supply turns on.

These capacitance values are just for reference, so the confirmation with the actual application is essential to determine the values appropriately.

RF Routing

Power current (output current) flows through the RF line. Make sure to short-circuit the line from RF through GND as well as GND. The RF resistance must choose enough power rating.

External FET Output Pins

Since the pins have to tolerate surge of current, make sure that the wires are thick and short enough when designing the PCB board.

Thermal Test Conditions

LV8856xJA (x = 1,2,3 or 4)

Size: 114.3 mm x 76.1 mm x 1.6 mm

Material: Glass epoxy single layer board

LV8856xR (x = 1,2,3 or 4)

Size: 50.0 mm x 40.0 mm x 0.8 mm

Material: Glass epoxy 4-layer board

MECHANICAL CASE OUTLINE
PACKAGE DIMENSIONS



SSOP20J (225mil)
CASE 565AP
ISSUE A

DATE 23 OCT 2013

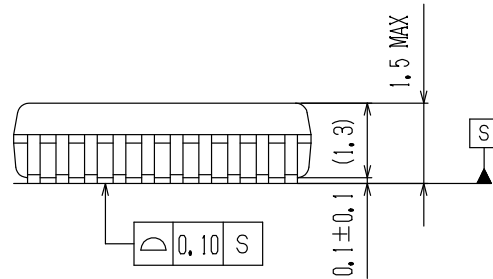
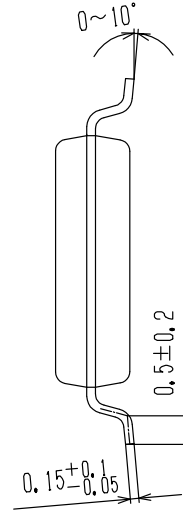
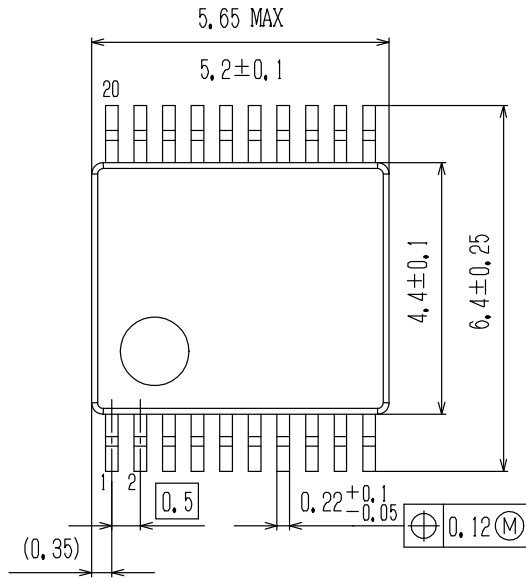
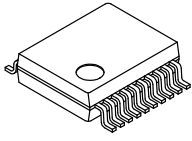

SOLDERING FOOTPRINT*

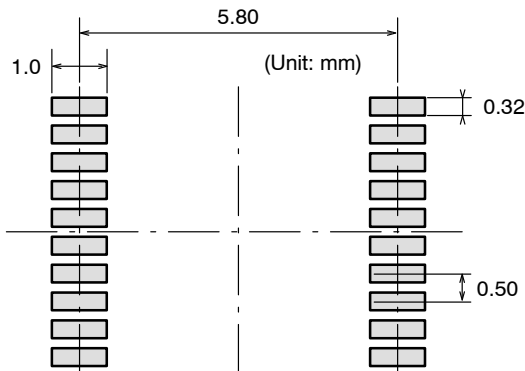

GENERIC MARKING DIAGRAM*

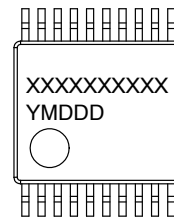

XXXXX = Specific Device Code
 Y = Year
 M = Month
 DDD = Additional Traceability Data

NOTE: The measurements are not to guarantee but for reference only.

*For additional information on our Pb-Free strategy and soldering details, please download the ON Semiconductor Soldering and Mounting Techniques Reference Manual, SOLDERRM/D.

*This information is generic. Please refer to device data sheet for actual part marking. Pb-Free indicator, "G" or microdot "▪", may or may not be present.

DOCUMENT NUMBER:	98AON66067E	Electronic versions are uncontrolled except when accessed directly from the Document Repository. Printed versions are uncontrolled except when stamped "CONTROLLED COPY" in red.
DESCRIPTION:	SSOP20J (225MIL)	PAGE 1 OF 1

ON Semiconductor and are trademarks of Semiconductor Components Industries, LLC dba ON Semiconductor or its subsidiaries in the United States and/or other countries. ON Semiconductor reserves the right to make changes without further notice to any products herein. ON Semiconductor makes no warranty, representation or guarantee regarding the suitability of its products for any particular purpose, nor does ON Semiconductor assume any liability arising out of the application or use of any product or circuit, and specifically disclaims any and all liability, including without limitation special, consequential or incidental damages. ON Semiconductor does not convey any license under its patent rights nor the rights of others.

MECHANICAL CASE OUTLINE PACKAGE DIMENSIONS

ON Semiconductor®



VCT20 3x3, 0.5P CASE 601AB ISSUE A

DATE 15 NOV 2013

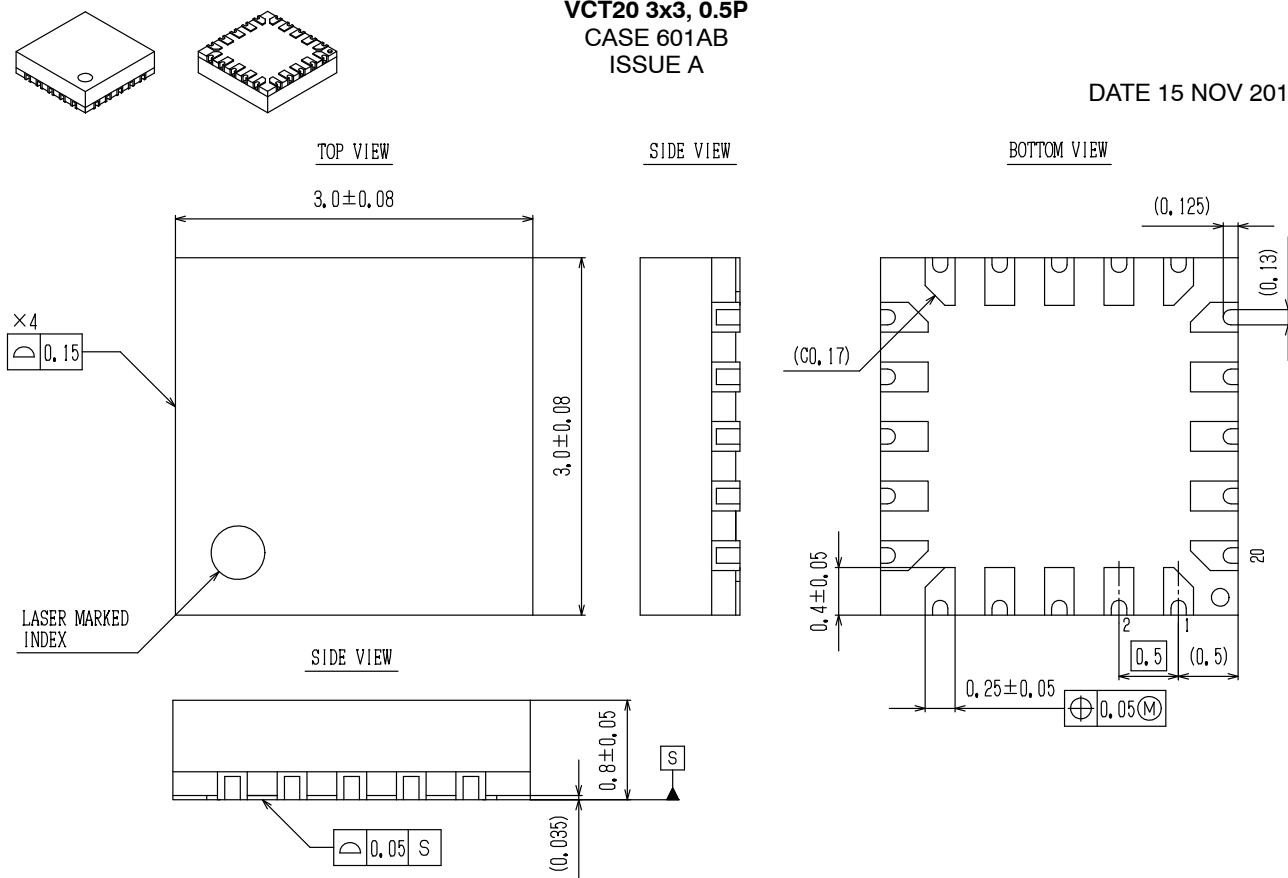

SOLDERING FOOTPRINT*

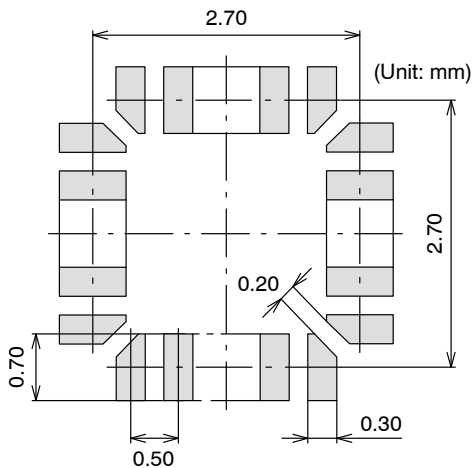

GENERIC MARKING DIAGRAM*



XXXXXX = Specific Device Code
Y = Year
M = Month
DDD = Additional Traceability Data

XXXXXX = Specific Device Code
Y = Year
DD = Additional Traceability Data

*This information is generic. Please refer to device data sheet for actual part marking. Pb-Free indicator, "G" or microdot "▪", may or may not be present.

NOTE: The measurements are not to guarantee but for reference only.

*For additional information on our Pb-Free strategy and soldering details, please download the ON Semiconductor Soldering and Mounting Techniques Reference Manual, SOLDERRM/D.

DOCUMENT NUMBER:	98AON78679E	Electronic versions are uncontrolled except when accessed directly from the Document Repository. Printed versions are uncontrolled except when stamped "CONTROLLED COPY" in red.
DESCRIPTION:	VCT20 3X3, 0.5P	PAGE 1 OF 1

ON Semiconductor and are trademarks of Semiconductor Components Industries, LLC dba ON Semiconductor or its subsidiaries in the United States and/or other countries. ON Semiconductor reserves the right to make changes without further notice to any products herein. ON Semiconductor makes no warranty, representation or guarantee regarding the suitability of its products for any particular purpose, nor does ON Semiconductor assume any liability arising out of the application or use of any product or circuit, and specifically disclaims any and all liability, including without limitation special, consequential or incidental damages. ON Semiconductor does not convey any license under its patent rights nor the rights of others.

ON Semiconductor and  are trademarks of Semiconductor Components Industries, LLC dba ON Semiconductor or its subsidiaries in the United States and/or other countries. ON Semiconductor owns the rights to a number of patents, trademarks, copyrights, trade secrets, and other intellectual property. A listing of ON Semiconductor's product/patent coverage may be accessed at www.onsemi.com/site/pdf/Patent-Marking.pdf. ON Semiconductor reserves the right to make changes without further notice to any products herein. ON Semiconductor makes no warranty, representation or guarantee regarding the suitability of its products for any particular purpose, nor does ON Semiconductor assume any liability arising out of the application or use of any product or circuit, and specifically disclaims any and all liability, including without limitation special, consequential or incidental damages. Buyer is responsible for its products and applications using ON Semiconductor products, including compliance with all laws, regulations and safety requirements or standards, regardless of any support or applications information provided by ON Semiconductor. "Typical" parameters which may be provided in ON Semiconductor data sheets and/or specifications can and do vary in different applications and actual performance may vary over time. All operating parameters, including "Typicals" must be validated for each customer application by customer's technical experts. ON Semiconductor does not convey any license under its patent rights nor the rights of others. ON Semiconductor products are not designed, intended, or authorized for use as a critical component in life support systems or any FDA Class 3 medical devices or medical devices with a same or similar classification in a foreign jurisdiction or any devices intended for implantation in the human body. Should Buyer purchase or use ON Semiconductor products for any such unintended or unauthorized application, Buyer shall indemnify and hold ON Semiconductor and its officers, employees, subsidiaries, affiliates, and distributors harmless against all claims, costs, damages, and expenses, and reasonable attorney fees arising out of, directly or indirectly, any claim of personal injury or death associated with such unintended or unauthorized use, even if such claim alleges that ON Semiconductor was negligent regarding the design or manufacture of the part. ON Semiconductor is an Equal Opportunity/Affirmative Action Employer. This literature is subject to all applicable copyright laws and is not for resale in any manner.

PUBLICATION ORDERING INFORMATION

LITERATURE FULFILLMENT:

Email Requests to: orderlit@onsemi.com

ON Semiconductor Website: www.onsemi.com

TECHNICAL SUPPORT

North American Technical Support:
Voice Mail: 1 800-282-9855 Toll Free USA/Canada
Phone: 011 421 33 790 2910

Europe, Middle East and Africa Technical Support:

Phone: 00421 33 790 2910

For additional information, please contact your local Sales Representative