



Is Now Part of



**ON Semiconductor®**

To learn more about ON Semiconductor, please visit our website at  
[www.onsemi.com](http://www.onsemi.com)

Please note: As part of the Fairchild Semiconductor integration, some of the Fairchild orderable part numbers will need to change in order to meet ON Semiconductor's system requirements. Since the ON Semiconductor product management systems do not have the ability to manage part nomenclature that utilizes an underscore (\_), the underscore (\_) in the Fairchild part numbers will be changed to a dash (-). This document may contain device numbers with an underscore (\_). Please check the ON Semiconductor website to verify the updated device numbers. The most current and up-to-date ordering information can be found at [www.onsemi.com](http://www.onsemi.com). Please email any questions regarding the system integration to [Fairchild\\_questions@onsemi.com](mailto:Fairchild_questions@onsemi.com).

ON Semiconductor and the ON Semiconductor logo are trademarks of Semiconductor Components Industries, LLC dba ON Semiconductor or its subsidiaries in the United States and/or other countries. ON Semiconductor owns the rights to a number of patents, trademarks, copyrights, trade secrets, and other intellectual property. A listing of ON Semiconductor's product/patent coverage may be accessed at [www.onsemi.com/site/pdf/Patent-Marking.pdf](http://www.onsemi.com/site/pdf/Patent-Marking.pdf). ON Semiconductor reserves the right to make changes without further notice to any products herein. ON Semiconductor makes no warranty, representation or guarantee regarding the suitability of its products for any particular purpose, nor does ON Semiconductor assume any liability arising out of the application or use of any product or circuit, and specifically disclaims any and all liability, including without limitation special, consequential or incidental damages. Buyer is responsible for its products and applications using ON Semiconductor products, including compliance with all laws, regulations and safety requirements or standards, regardless of any support or applications information provided by ON Semiconductor. "Typical" parameters which may be provided in ON Semiconductor data sheets and/or specifications can and do vary in different applications and actual performance may vary over time. All operating parameters, including "Typicals" must be validated for each customer application by customer's technical experts. ON Semiconductor does not convey any license under its patent rights nor the rights of others. ON Semiconductor products are not designed, intended, or authorized for use as a critical component in life support systems or any FDA Class 3 medical devices or medical devices with a same or similar classification in a foreign jurisdiction or any devices intended for implantation in the human body. Should Buyer purchase or use ON Semiconductor products for any such unintended or unauthorized application, Buyer shall indemnify and hold ON Semiconductor and its officers, employees, subsidiaries, affiliates, and distributors harmless against all claims, costs, damages, and expenses, and reasonable attorney fees arising out of, directly or indirectly, any claim of personal injury or death associated with such unintended or unauthorized use, even if such claim alleges that ON Semiconductor was negligent regarding the design or manufacture of the part. ON Semiconductor is an Equal Opportunity/Affirmative Action Employer. This literature is subject to all applicable copyright laws and is not for resale in any manner.

# FAN6921AMR

## Integrated Critical-Mode PFC and Quasi-Resonant Current-Mode PWM Controller

### Features

- Integrated PFC and Flyback Controller
- Critical-Mode PFC Controller
- Zero-Current Detection for PFC Stage
- Quasi-Resonant Operation for PWM Stage
- Internal Minimum  $t_{OFF}$  8  $\mu$ s for QR PWM Stage
- Internal 10 ms Soft-Start for PWM
- Brownout Protection
- High / Low Line Over-Power Compensation
- Auto-Recovery Over-Current Protection
- Auto-Recovery Open-Loop Protection
- Externally Latch Triggering (RT Pin)
- Adjustable Over-Temperature Latched (RT Pin)
- VDD Pin and Output Voltage OVP (Latched)
- Internal Over-Temperature Shutdown (140°C)

### Applications

- AC/DC NB Adapters
- Open-Frame SMPS
- Battery Charger

### Description

The highly integrated FAN6921AMR combines a Power Factor Correction (PFC) controller and a Quasi-Resonant PWM controller. Integration provides cost-effect design and allows for fewer external components.

For PFC, FAN6921AMR uses a controlled on-time technique to provide a regulated DC output voltage and to perform natural power factor correction. An innovative THD optimizer reduces input current distortion at zero-crossing duration to improve THD performance.

For PWM, FAN6921AMR provides several functions to enhance power system performance: valley detection, green-mode operation, high / low line over-power compensation. Protection functions include secondary-side open-loop and over-current with auto-recovery protection, external latch triggering, adjustable over-temperature protection by the RT pin and external NTC resistor, internal over-temperature shutdown, VDD pin OVP, DET pin over-voltage for output OVP, and brown-in / out for AC input voltage UVP.

The FAN6921AMR controller is available in a 16-pin, small-outline package (SOP).

### Ordering Information

Part Number	OLP Mode	Operating Temperature Range	Package	Packing Method
FAN6921AMRMY	Recovery	-40°C to +105°C	16-Pin, Small-Outline Package (SOP)	Tape & Reel



### Internal Block Diagram

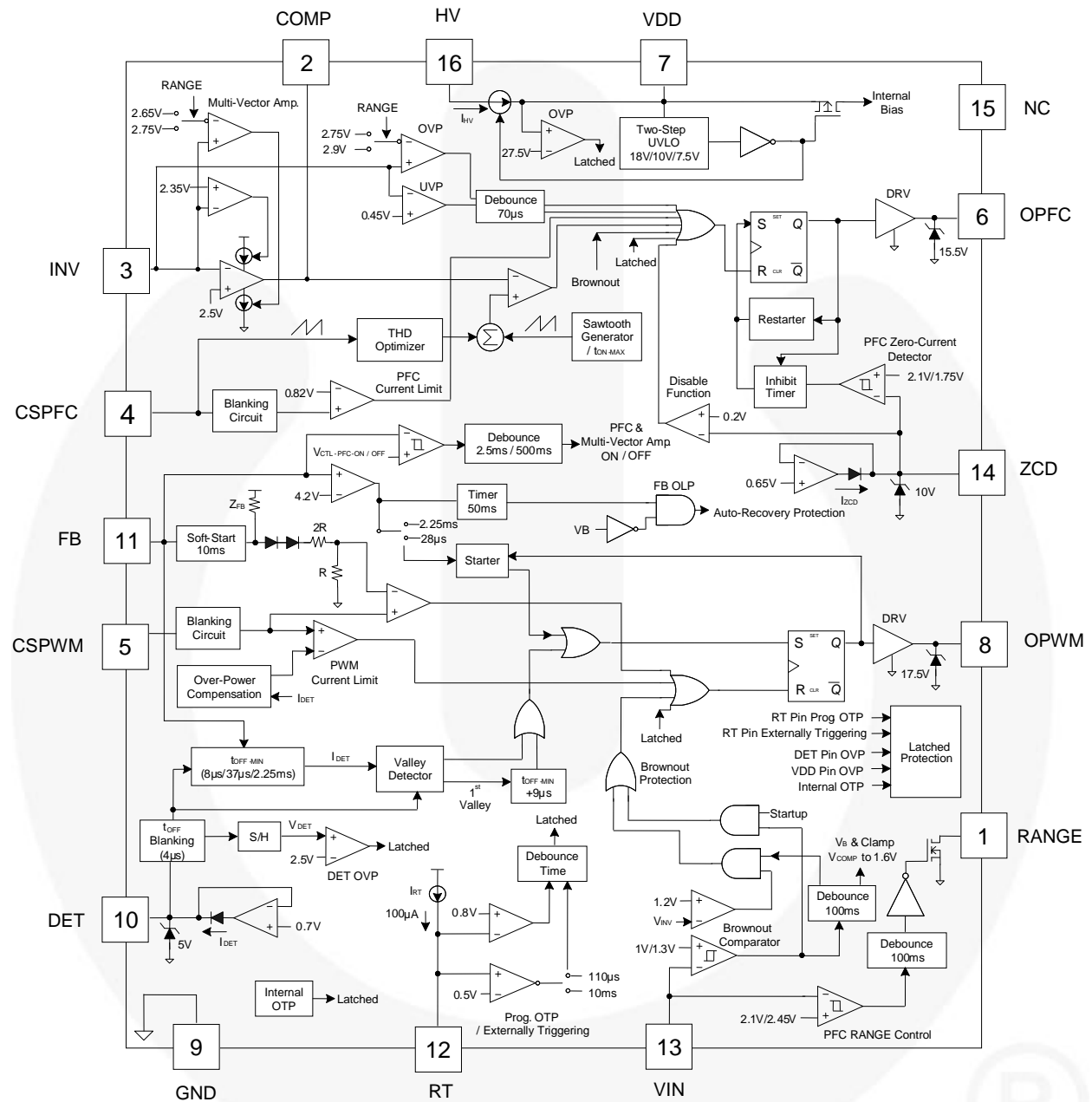

Figure 2. Functional Block Diagram

## Marking Information

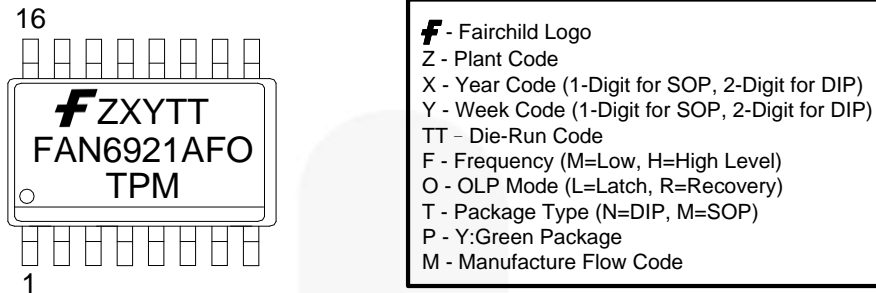

Figure 3. Marking Diagram

## Pin Configuration

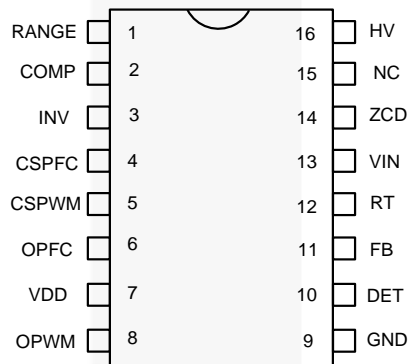

Figure 4. Pin Configuration

## Pin Definitions

Pin #	Name	Description
1	RANGE	RANGE pin's impedance changes according to the VIN pin voltage level. When the input voltage detected by the VIN pin is lower than a threshold voltage, it sets to high impedance; whereas it sets to low impedance if input voltage is at a high level.
2	COMP	Output pin of the error amplifier. Transconductance-type error amplifier for PFC output voltage feedback. Proprietary multi-vector current is built-in to this amplifier; therefore, the compensation for PFC voltage feedback loop allows a simple compensation circuit between this pin and GND.
3	INV	Inverting input of the error amplifier. This pin is used to receive PFC voltage level by a voltage divider and provides PFC output over- and under-voltage protections.
4	CSPFC	Input to the PFC over-current protection comparator that provides cycle-by-cycle current limiting protection. When the sensed voltage across the PFC current-sensing resistor reaches the internal threshold (0.82 V typical), the PFC switch is turned off to activate cycle-by-cycle current limiting.
5	CSPWM	Input to the comparator of the PWM over-current protection and performs PWM current-mode control with FB pin voltage. A resistor is used to sense the switching current of the PWM switch and the sensing voltage is applied to the CSPWM pin for the cycle-by-cycle current limit, current-mode control, and high / low line over-power compensation according to the DET pin source current during PWM $t_{ON}$ time.

Continued on the following page...

**Pin Definitions** (Continued)

Pin #	Name	Description
6	OPFC	Totem-pole driver output to drive the external power MOSFET. The clamped gate output voltage is 15.5 V.
7	VDD	Power supply. The threshold voltages for startup and turn-off are 18 V and 7.5 V, respectively. The startup current is less than 30 $\mu$ A and the operating current is lower than 10 mA.
8	OPWM	Totem-pole output generates the PWM signal to drive the external power MOSFET. The clamped gate output voltage is 17.5 V.
9	GND	The power ground and signal ground.
10	DET	This pin is connected to an auxiliary winding of the PWM transformer through a resistor divider for the following purposes: <ul style="list-style-type: none"> <li>Producing an offset voltage to compensate the threshold voltage of PWM current limit for providing over-power compensation. The offset is generated in accordance with the input voltage when the PWM switch is on.</li> <li>Detecting the valley voltage signal of drain voltage of the PWM switch to achieve the valley voltage switching and minimize the switching loss on the PWM switch.</li> <li>Providing output over-voltage protection. A voltage comparator is built-in to the DET pin. The DET pin detects the flat voltage through a voltage divider paralleled with auxiliary winding. This flat voltage is reflected to the secondary winding during PWM inductor discharge time. If output OVP and this flat voltage is higher than 2.5 V, the controller enters latch mode and stops all PFC and PWM switching operation.</li> </ul>
11	FB	Feedback voltage pin. This pin is used to receive the output voltage level signal to determine PWM gate duty for regulating output voltage. The FB pin voltage can also activate open-loop, overload, and output-short circuit protection if the FB pin voltage is higher than a threshold of around 4.2 V for more than 50 ms. The input impedance of this pin is a 5 k $\Omega$ equivalent resistance. A one-third attenuator is connected between the FB pin and the input of the CSPWM/FB comparator.
12	RT	Adjustable over-temperature protection and external latch triggering. A constant current is flowed out of the RT pin. When the RT pin voltage is lower than 0.8 V (typical), latch-mode protection is activated and stops all PFC and PWM switching operation until the AC plug is disconnected.
13	VIN	Line-voltage detection for brown-in / out protections. This pin can receive the AC input voltage level through a voltage divider. The voltage level of the VIN pin is not only used to control RANGE pin's status; (ZCD) can also perform brown-in / out protection for AC input voltage UVP.
14	ZCD	Zero-current detection for the PFC stage. This pin is connected to an auxiliary winding coupled to PFC inductor winding to detect the ZCD voltage signal once the PFC inductor current discharges to zero. When the ZCD voltage signal is detected, the controller starts a new PFC switching cycle. When the ZCD pin voltage is pulled to under 0.2 V (typical), it disables the PFC stage and the controller stops PFC switching. This can be achieved with an external circuit if disabling the PFC stage is desired.
15	NC	No connection
16	HV	High-voltage startup. HV pin is connected to the AC line voltage through a resistor 100 k $\Omega$ typical) for providing a high charging current to V <sub>DD</sub> capacitor.

## Absolute Maximum Ratings

Stresses exceeding the absolute maximum ratings may damage the device. The device may not function or be operable above the recommended operating conditions and stressing the parts to these levels is not recommended. In addition, extended exposure to stresses above the recommended operating conditions may affect device reliability. The absolute maximum ratings are stress ratings only.

Symbol	Parameter	Min.	Max.	Unit
V <sub>DD</sub>	DC Supply Voltage		30	V
V <sub>HV</sub>	HV Pin Voltage		500	V
V <sub>H</sub>	OPFC, OPWM Pin Voltage	-0.3	25.0	V
V <sub>L</sub>	Other Pins (INV, COMP, CSPFC, DET, FB, CSPWM, RT)	-0.3	7.0	V
V <sub>ZCD</sub>	Input Voltage to ZCD Pin	-0.3	12.0	V
P <sub>D</sub>	Power Dissipation		800	mW
$\theta_{JA}$	Thermal Resistance (Junction-to-Air)		104	°C/W
$\theta_{JC}$	Thermal Resistance (Junction-to-Case)		41	°C/W
T <sub>J</sub>	Operating Junction Temperature	-40	+150	°C
T <sub>STG</sub>	Storage Temperature Range	-55	+150	°C
T <sub>L</sub>	Lead Temperature (Soldering 10 Seconds)		+260	°C
ESD	Human Body Model, JESD22-A114 (All Pins Except HV Pin) <sup>(3)</sup>		5000	V
	Charged Device Model, JESD22-C101 (All Pins Except HV Pin) <sup>(3)</sup>		2000	

### Notes:

1. Stresses beyond those listed under Absolute Maximum Ratings may cause permanent damage to the device.
2. All voltage values, except differential voltages, are given with respect to GND pin.
3. All pins including HV pin: CDM=1000 V, HBM 1000 V.

## Recommended Operating Conditions

The Recommended Operating Conditions table defines the conditions for actual device operation. Recommended operating conditions are specified to ensure optimal performance to the datasheet specifications. Fairchild does not recommend exceeding them or designing to Absolute Maximum Ratings.

Symbol	Parameter	Min.	Max.	Unit
T <sub>A</sub>	Operating Ambient Temperature	-40	+105	°C

## Electrical Characteristics

$V_{DD}=15\text{ V}$ ,  $T_A=-40^{\circ}\text{C}\sim 105^{\circ}\text{C}$  ( $T_A=T_J$ ), unless otherwise specified.

Symbol	Parameter	Condition	Min.	Typ.	Max.	Unit
<b>V<sub>DD</sub> Section</b>						
$V_{OP}$	Continuously Operating Voltage				25	V
$V_{DD-ON}$	Turn-On Threshold Voltage		16.5	18.0	19.5	V
$V_{DD-PWM-OFF}$	PWM-Off Threshold Voltage		9	10	11	V
$V_{DD-OFF}$	Turn-Off Threshold Voltage		6.5	7.5	8.5	V
$I_{DD-ST}$	Startup Current	$V_{DD}=V_{DD-ON} - 0.16\text{ V}$ , Gate Open		20	30	$\mu\text{A}$
$I_{DD-OP}$	Operating Current	$V_{DD}=15\text{ V}$ ; OPFC, OPWM=100 kHz; $C_{L-PFC}$ , $C_{L-PWM}=2\text{ nF}$			10	mA
$I_{DD-GREEN}$	Green-Mode Operating Supply Current (Average)	$V_{DD}=15\text{ V}$ , OPWM=450 Hz, $C_{L-PWM}=2\text{ nF}$		5.5		mA
$I_{DD-PWM-OFF}$	Operating Current at PWM-Off Phase	$V_{DD}=V_{DD-PWM-OFF} - 0.5\text{ V}$	70	120	170	$\mu\text{A}$
$V_{DD-OVP}$	$V_{DD}$ Over-Voltage Protection (Latch-Off)		26.5	27.5	28.5	V
$t_{VDD-OVP}$	$V_{DD}$ OVP Debounce Time		100	150	200	$\mu\text{s}$
$I_{DD-LATCH}$	$V_{DD}$ Over-Voltage Protection Latch-Up Holding Current	$V_{DD}=7.5\text{ V}$		120		$\mu\text{A}$
<b>HV Startup Current Source Section</b>						
$V_{HV-MIN}$	Minimum Startup Voltage on HV Pin				50	V
$I_{HV}$	Supply Current Drawn from HV Pin	$V_{AC}=90\text{ V}$ ( $V_{DC}=120\text{ V}$ ), $V_{DD}=0\text{ V}$	1.3			mA
		HV=500 V, $V_{DD}=V_{DD-OFF} + 1\text{ V}$		1		$\mu\text{A}$
<b>V<sub>VIN</sub> and RANGE Section</b>						
$V_{VIN-UVP}$	Threshold Voltage for AC Input Under-Voltage Protection		0.95	1.00	1.05	V
$V_{VIN-RE-UVP}$	Under-Voltage Protection Reset Voltage (for Startup)		$V_{VIN-UVP} + 0.25\text{ V}$	$V_{VIN-UVP} + 0.30\text{ V}$	$V_{VIN-UVP} + 0.35\text{ V}$	V
$t_{VIN-UVP}$	Under-Voltage Protection Debounce Time (No Need at Startup and Hiccup Mode)		70	100	130	ms
$V_{VIN-RANGE-H}$	High $V_{VIN}$ Threshold for RANGE Comparator		2.40	2.45	2.50	V
$V_{VIN-RANGE-L}$	Low $V_{VIN}$ Threshold for RANGE Comparator		2.05	2.10	2.15	V
$t_{RANGE}$	Range Enable / Disable Debounce Time		70	100	130	ms
$V_{RANGE-OL}$	Output Low Voltage of RANGE Pin	$I_O=1\text{ mA}$			0.5	V
$I_{RANGE-OH}$	Output High Leakage Current of RANGE Pin	RANGE=5 V			50	nA
$t_{ON-MAX-PFC}$	PFC Maximum On-Time	$R_{MOT}=24\text{ k}\Omega$	22	25	28	$\mu\text{s}$

Continued on the following page...



### Electrical Characteristics (Continued)

$V_{DD}=15\text{ V}$ ,  $T_A=-40^\circ\text{C} \sim 105^\circ\text{C}$  ( $T_A=T_J$ ), unless otherwise specified.

Symbol	Parameter	Condition	Min.	Typ.	Max.	Unit
<b>PFC Stage</b>						
<b>Voltage Error Amplifier Section</b>						
G <sub>m</sub>	Transconductance <sup>(4)</sup>		100	125	150	μmho
V <sub>REF</sub>	Feedback Comparator Reference Voltage		2.465	2.500	2.535	V
V <sub>INV-H</sub>	Clamp High Feedback Voltage	RANGE=Open	2.70	2.75	2.80	V
		RANGE=Ground	2.60	2.65	2.70	
V <sub>RATIO</sub>	Clamp High Output Voltage Ratio <sup>(4)</sup>	V <sub>INVH</sub> / V <sub>REF</sub> , RANGE=Open	1.06		1.14	V/V
		V <sub>INVH</sub> / V <sub>REF</sub> , RANGE=Ground	1.04		1.08	
V <sub>INV-L</sub>	Clamp Low Feedback Voltage		2.25	2.35	2.45	V
V <sub>INV-OVP</sub>	Over-Voltage Protection for INV Input	RANGE=Open		2.90	2.95	V
		RANGE=Ground		2.75	2.80	
t <sub>INV-OVP</sub>	Over-Voltage Protection Debounce Time		50	70	90	μs
V <sub>INV-UVP</sub>	Under-Voltage Protection for INV Input		0.35	0.45	0.55	V
t <sub>INV-UVP</sub>	Under-Voltage Protection Debounce Time		50	70	90	μs
V <sub>INV-BO</sub>	PWM and PFC Off Threshold for Brownout Protection		1.15	1.20	1.25	V
V <sub>COMP-BO</sub>	Limited Voltage on COMP Pin for Brownout Protection		1.55	1.60	1.65	V
V <sub>COMP</sub>	Comparator Output High Voltage		4.8		6.0	V
V <sub>OZ</sub>	Zero Duty Cycle Voltage on COMP Pin		1.10	1.25	1.40	V
I <sub>COMP</sub>	Comparator Output Source Current	V <sub>INV</sub> =2.3 V, V <sub>COMP</sub> =1.5 V	15	30	45	μA
		V <sub>INV</sub> =1.5 V	0.50	0.75	1.00	mA
	Comparator Output Sink Current	RANGE=Open, V <sub>INV</sub> =2.75 V, V <sub>COMP</sub> =5 V	20	30	40	μA
		RANGE=Ground, V <sub>INV</sub> =2.65 V, V <sub>COMP</sub> =5 V	20	30	40	
<b>PFC Current-Sense Section</b>						
V <sub>CSPFC</sub>	Threshold Voltage for Peak Current Cycle-by-Cycle Limit	V <sub>COMP</sub> =5 V		0.82		V
t <sub>PD</sub>	Propagation Delay			110	200	ns
t <sub>BNK</sub>	Leading-Edge Blanking Time		110	180	250	ns
A <sub>V</sub>	CSPFC Compensation Ratio for THD		0.90	0.95	1.00	V/V

Continued on the following page...

**Electrical Characteristics** (Continued)

$V_{DD}=15\text{ V}$ ,  $T_A=-40^\circ\text{C} \sim 105^\circ\text{C}$  ( $T_A=T_J$ ), unless otherwise specified.

Symbol	Parameter	Condition	Min.	Typ.	Max.	Unit
<b>PFC Output Section</b>						
$V_Z$	PFC Gate Output Clamping Voltage	$V_{DD}=25\text{ V}$	14.0	15.5	17.0	V
$V_{OL}$	PFC Gate Output Voltage Low	$V_{DD}=15\text{ V}$ , $I_O=100\text{ mA}$			1.5	V
$V_{OH}$	PFC Gate Output Voltage High	$V_{DD}=15\text{ V}$ , $I_O=100\text{ mA}$	8			V
$t_R$	PFC Gate Output Rising Time	$V_{DD}=12\text{ V}$ , $C_L=3\text{ nF}$ , 20~80%	30	65	100	ns
$t_F$	PFC Gate Output Falling Time	$V_{DD}=12\text{ V}$ , $C_L=3\text{ nF}$ , 80~20%	30	50	70	ns
<b>PFC Zero-Current Detection Section</b>						
$V_{ZCD}$	Input Threshold Voltage Rising Edge	$V_{ZCD}$ Increasing	1.9	2.1	2.3	V
$V_{ZCD-HYST}$	Threshold Voltage Hysteresis	$V_{ZCD}$ Decreasing	0.25	0.35	0.45	V
$V_{ZCD-HIGH}$	Upper Clamp Voltage	$I_{ZCD}=3\text{ mA}$	8	10		V
$V_{ZCD-LOW}$	Lower Clamp Voltage		0.40	0.65	0.90	V
$V_{ZCD-SSC}$	Starting Source Current Threshold Voltage		1.3	1.4	1.5	V
$t_{DELAY}$	Maximum Delay from ZCD to Output Turn-On	$V_{COMP}=5\text{ V}$ , $f_S=60\text{ kHz}$	100		200	ns
$t_{RESTART-PFC}$	Restart Time		300	500	700	$\mu\text{s}$
$t_{INHIB}$	Inhibit Time (Maximum Switching Frequency Limit)	$V_{COMP}=5\text{ V}$	1.5	2.5	3.5	$\mu\text{s}$
$V_{ZCD-DIS}$	PFC Enable / Disable Function Threshold Voltage		0.15	0.20	0.25	V
$t_{ZCD-DIS}$	PFC Enable / Disable Function Debounce Time	$V_{ZCD}=100\text{ mV}$	100	150	200	$\mu\text{s}$

Continued on the following page...

**Electrical Characteristics** (Continued)V<sub>DD</sub>=15 V, T<sub>A</sub>=-40°C ~105°C (T<sub>A</sub>=T<sub>J</sub>), unless otherwise specified.

Symbol	Parameter	Condition	Min.	Typ.	Max.	Unit
<b>PWM STAGE</b>						
<b>Feedback Input Section</b>						
A <sub>V</sub>	Input-Voltage to Current-Sense Attenuation <sup>(4)</sup>	$A_V = \Delta V_{CSPWM} / \Delta V_{FB}$ , 0 < V <sub>CSPWM</sub> < 0.9	1/2.75	1/3.00	1/3.25	V/V
Z <sub>FB</sub>	Input Impedance <sup>(4)</sup>	FB > V <sub>G</sub>	3	5	7	kΩ
I <sub>OZ</sub>	Bias Current	FB = V <sub>OZ</sub>		1.2	2.0	mA
V <sub>OZ</sub>	Zero Duty-Cycle Input Voltage		0.7	0.9	1.1	V
V <sub>FB-OLP</sub>	Open-Loop Protection Threshold Voltage		3.9	4.2	4.5	V
t <sub>FB-OLP</sub>	Debounce Time for Open-Loop Protection		40	50	60	ms
t <sub>FB-SS</sub>	Internal Soft-Start Time <sup>(4)</sup>	V <sub>FB</sub> =0 V ~3.6 V	8.5	9.5	10.5	ms
<b>DET Pin OVP and Valley Detection Section</b>						
V <sub>DET-OVP</sub>	Comparator Reference Voltage		2.45	2.50	2.55	V
A <sub>V</sub>	Open-Loop Gain <sup>(4)</sup>			60		dB
BW	Gain Bandwidth <sup>(4)</sup>			1		MHz
t <sub>DET-OVP</sub>	Output OVP (Latched) Debounce Time		100	150	200	μs
I <sub>DET-SOURCE</sub>	Maximum Source Current	V <sub>DET</sub> =0 V			1	mA
V <sub>DET-HIGH</sub>	Upper Clamp Voltage	I <sub>DET</sub> =-1 mA			5	V
V <sub>DET-LOW</sub>	Lower Clamp Voltage	I <sub>DET</sub> =1 mA	0.5	0.7	0.9	V
t <sub>VALLEY-DELAY</sub>	Delay from Valley Signal Detected to Output Turn-on <sup>(4)</sup>		150	200	250	ns
t <sub>OFF-BNK</sub>	Leading-Edge Blanking Time for DET-OVP (2.5V) and Valley Signal when PWM MOS Turns Off <sup>(4)</sup>		3	4	5	μs
t <sub>TIME-OUT</sub>	Time-Out After t <sub>OFF-MIN</sub>		8	9	10	μs
<b>PWM Oscillator Section</b>						
t <sub>ON-MAX-PWM</sub>	Maximum On Time		38	45	52	μs
t <sub>OFF-MIN</sub>	Minimum Off-Time	V <sub>FB</sub> ≥ V <sub>N</sub> , T <sub>A</sub> =25°C	7	8	9	μs
		V <sub>FB</sub> =V <sub>G</sub>	32	37	42	
V <sub>N</sub>	Beginning of Green-On Mode at FB Voltage Level		1.95	2.10	2.25	V
V <sub>G</sub>	Beginning of Green-Off Mode at FB Voltage Level		1.00	1.15	1.30	V
ΔV <sub>G</sub>	Hysteresis for Beginning of Green-Off Mode at FB Voltage Level			0.1		V

Continued on the following page...

**Electrical Characteristics** (Continued) $V_{DD}=15V$ ,  $T_A=-40^{\circ}C \sim 105^{\circ}C$  ( $T_A=T_J$ ), unless otherwise specified.

Symbol	Parameter	Condition	Min.	Typ.	Max.	Unit
$V_{CTL-PFC-OFF}$	Threshold Voltage on FB Pin for PFC Enable → Disable	RANGE Pin Internally Open	1.80	1.85	1.90	V
		RANGE Pin Internally Ground	1.75	1.80	1.85	
$V_{CTL-PFC-ON}$	Threshold Voltage on FB Pin for PFC Disable → Enable	RANGE Pin Internally Open	1.90	1.95	2.00	V
		RANGE Pin Internally Ground	1.80	1.85	1.90	
$t_{PFC-OFF}$	PFC Disable Debounce Time	PFC Enable → Disable	400	500	600	ms
$t_{PFC-ON}$	PFC Enable Debounce Time	PFC Disable → Enable	2.0	2.5	3.0	ms
$t_{STARTER-PWM}$	Start Timer (Time-Out Timer)	$V_{FB} < V_G$	1.85	2.25	2.65	ms
		$V_{FB} > V_{FB-OLP}$	22	28	34	$\mu s$
<b>PWM Output Section</b>						
$V_{CLAMP}$	PWM Gate Output Clamping Voltage	$V_{DD}=25V$	16.0	17.5	19.0	V
$V_{OL}$	PWM Gate Output Voltage Low	$V_{DD}=15V$ , $I_O=100mA$			1.5	V
$V_{OH}$	PWM Gate Output Voltage High	$V_{DD}=15V$ , $I_O=100mA$	8			V
$t_R$	PWM Gate Output Rising Time	$C_L=3nF$ , $V_{DD}=12V$ , 20~80%		80	110	ns
$t_F$	PWM Gate Output Falling Time	$C_L=3nF$ , $V_{DD}=12V$ , 20~80%		40	70	ns
<b>Current Sense Section</b>						
$t_{PD}$	Delay to Output			150	200	ns
$V_{LIMIT}$	Limit Voltage on CSPWM Pin for Over-Power Compensation	$I_{DET} < 75\mu A$ , $T_A=25^{\circ}C$	0.81	0.84	0.87	V
		$I_{DET}=185\mu A$ , $T_A=25^{\circ}C$	0.69	0.72	0.75	
		$I_{DET}=350\mu A$ , $T_A=25^{\circ}C$	0.55	0.58	0.61	
		$I_{DET}=550\mu A$ , $T_A=25^{\circ}C$	0.37	0.40	0.43	
$V_{SLOPE}$	Slope Compensation <sup>(4)</sup>	$t_{ON}=45\mu s$ , RANGE=Open	0.25	0.30	0.35	V
		$t_{ON}=0\mu s$	0.05	0.10	0.15	
$t_{ON-BNK}$	Leading-Edge Blanking Time			300		ns
$V_{CS-FLOATING}$	CSPWM Pin Floating $V_{CSPWM}$ Clamped High Voltage	CSPWM Pin Floating	4.5		5.0	V
$t_{CS-H}$	Delay with CSPWM Pin Floating	CSPWM Pin Floating		150		$\mu s$

Continued on the following page...

**Electrical Characteristics** (Continued)

$V_{DD}=15\text{ V}$ ,  $T_A=-40^{\circ}\text{C} \sim 105^{\circ}\text{C}$  ( $T_A=T_J$ ), unless otherwise specified.

Symbol	Parameter	Condition	Min.	Typ.	Max.	Unit
<b>RT Pin Over-Temperature Protection Section</b>						
$T_{OTP}$	Internal Threshold Temperature for OTP <sup>(4)</sup>		+125	+140	+155	$^{\circ}\text{C}$
$T_{OTP-HYST}$	Hysteresis Temperature for Internal OTP <sup>(4)</sup>			30		$^{\circ}\text{C}$
$I_{RT}$	Internal Source Current of RT Pin		90	100	110	$\mu\text{A}$
$V_{RT-LATCH}$	Latch-Mode Triggering Voltage		0.75	0.80	0.85	V
$V_{RT-RE-LATCH}$	Latch-Mode Release Voltage		$V_{RT-LATCH} + 0.15$	$V_{RT-LATCH} + 0.20$	$V_{RT-LATCH} + 0.25$	V
$V_{RT-OTP-LEVEL}$	Threshold Voltage for Two-level Debounce Time		0.45	0.50	0.55	V
$t_{RT-OTP-H}$	Debounce Time for OTP			10		ms
$t_{RT-OTP-L}$	Debounce Time for Externally Triggering	$V_{RT} < V_{RT-OTP-LEVEL}$	70	110	150	$\mu\text{s}$

**Note:**

4. Guaranteed by design.

## Typical Performance Characteristics

These characteristic graphs are normalized at  $T_A=25^{\circ}\text{C}$ .

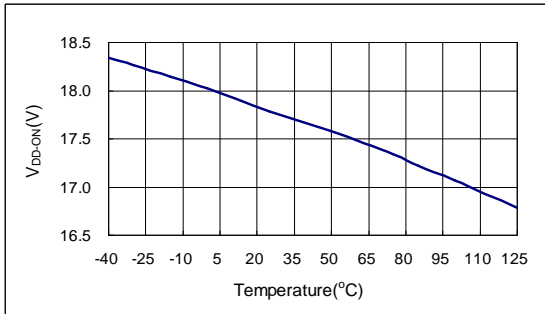

**Figure 5. Turn-On Threshold Voltage**

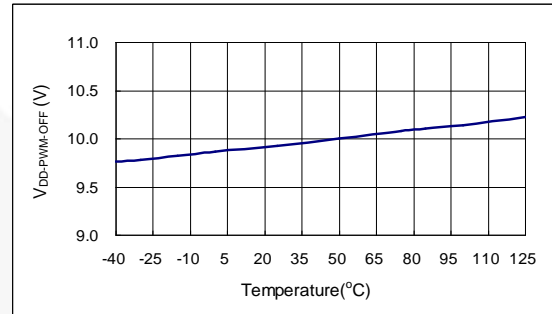

**Figure 6. PWM Off Threshold Voltage**

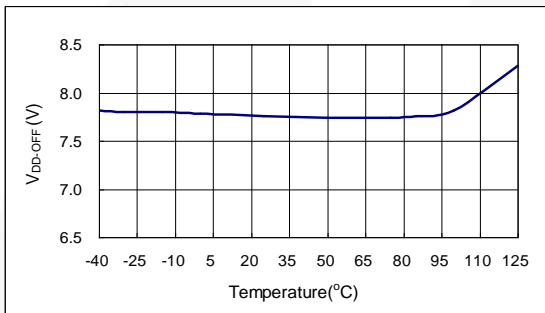

**Figure 7. Turn-Off Threshold Voltage**

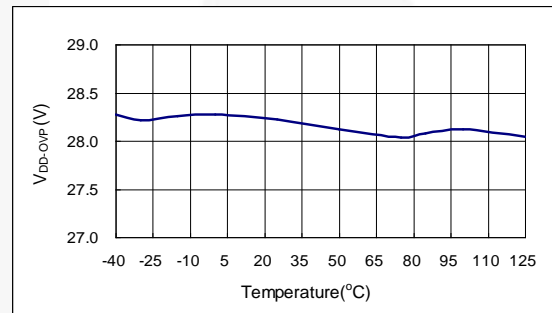

**Figure 8.  $V_{DD}$  Over-Voltage Protection Threshold**

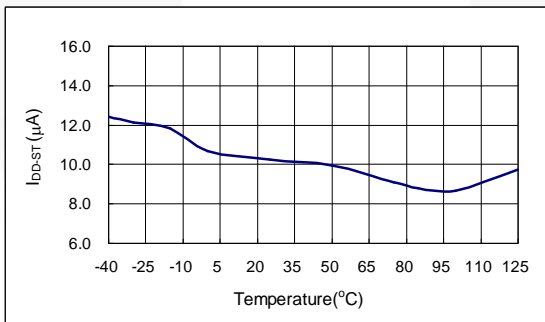

**Figure 9. Startup Current**

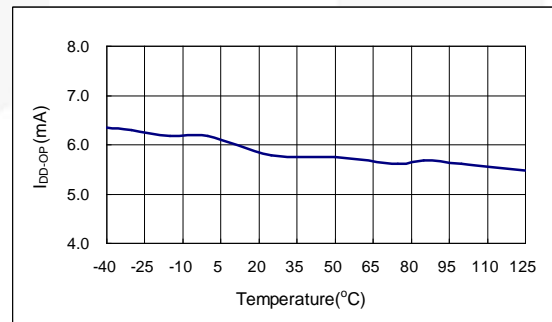

**Figure 10. Operating Current**

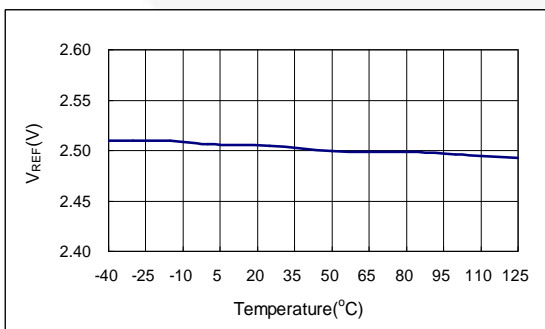

**Figure 11. PFC Output Feedback Reference Voltage**

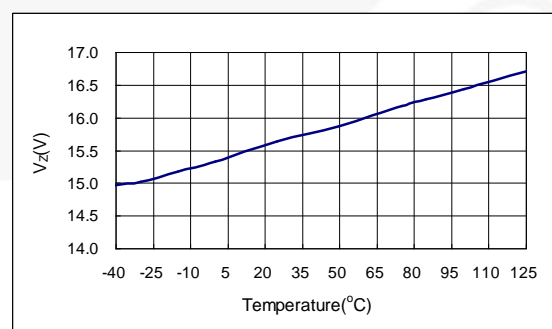

**Figure 12. PFC Gate Output Clamping Voltage**

## Typical Performance Characteristics (Continued)

These characteristic graphs are normalized at  $T_A=25^\circ\text{C}$ .

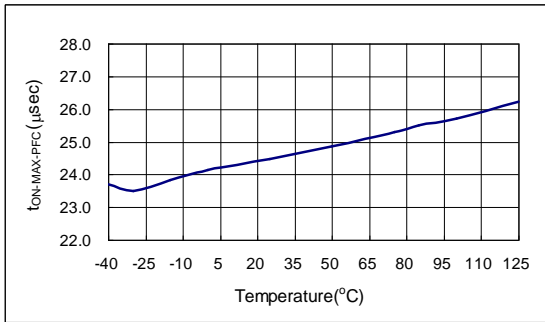

**Figure 13. PFC Maximum On-Time**

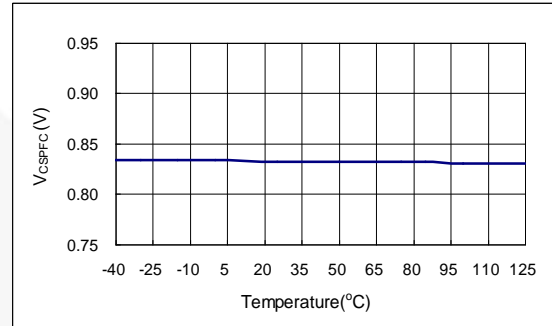

**Figure 14. PFC Peak Current Limit Voltage**

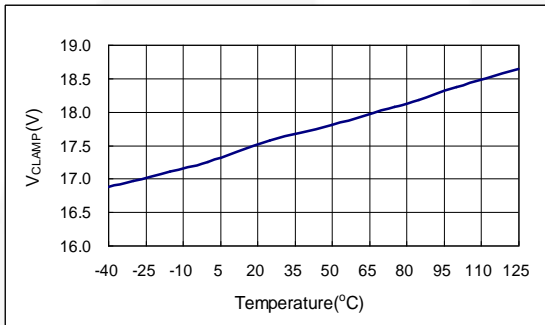

**Figure 15. PWM Gate Output Clamping Voltage**

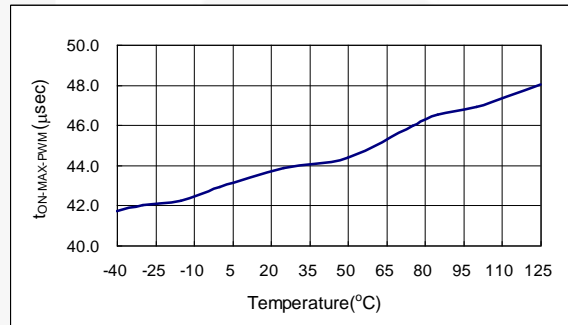

**Figure 16. PWM Maximum On-Time**

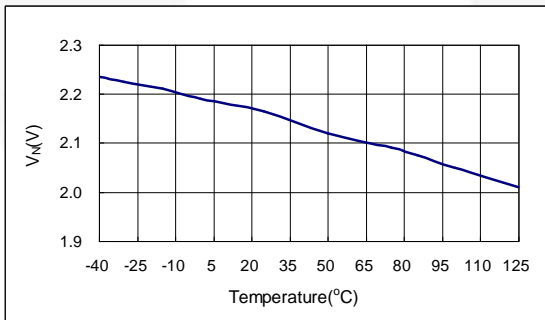

**Figure 17. Beginning of Green-On Mode at V<sub>FB</sub>**

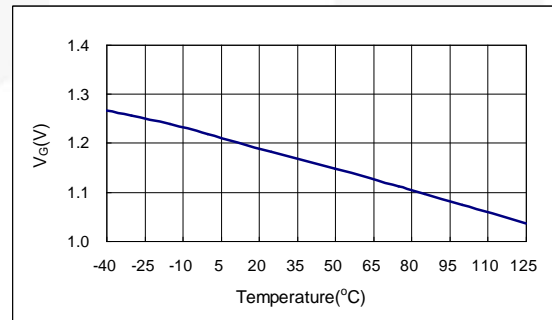

**Figure 18. Beginning of Green-Off Mode at V<sub>FB</sub>**

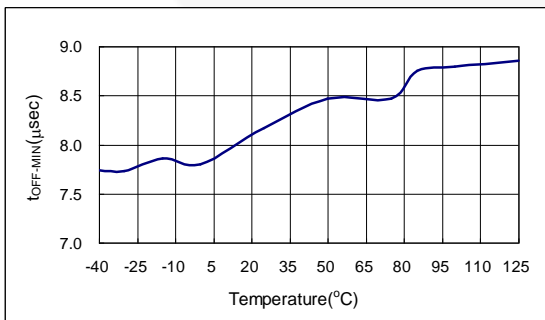

**Figure 19. PWM Minimum Off-Time for V<sub>FB</sub> > V<sub>N</sub>**

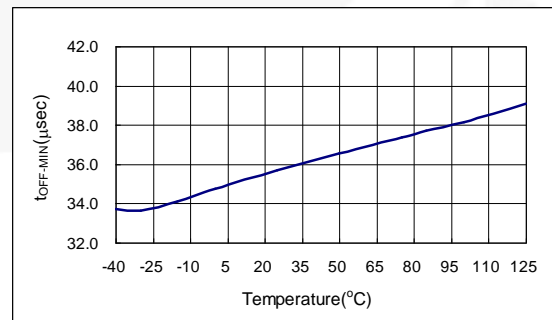

**Figure 20. PWM Minimum Off-Time for V<sub>FB</sub> = V<sub>G</sub>**

## Typical Performance Characteristics (Continued)

These characteristic graphs are normalized at  $T_A=25^\circ\text{C}$ .

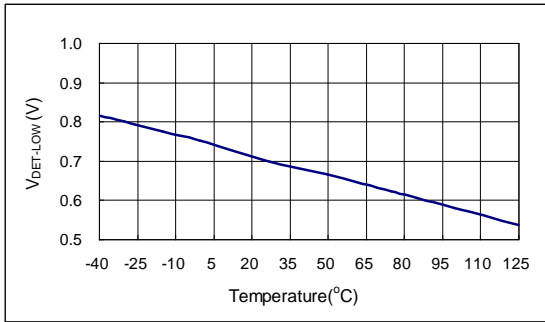

**Figure 21. Lower Clamp Voltage of DET Pin**

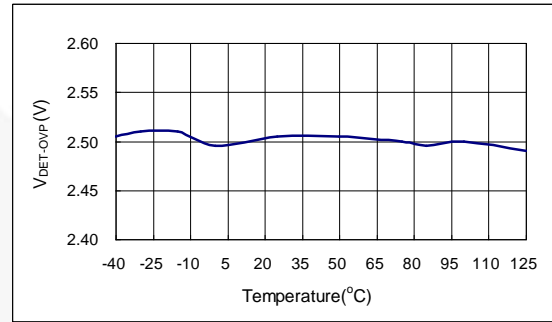

**Figure 22. Reference Voltage for Output Over-Voltage Protection of DET Pin**

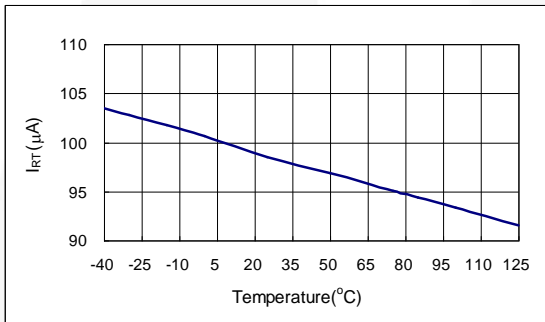

**Figure 23. Internal Source Current of RT Pin**

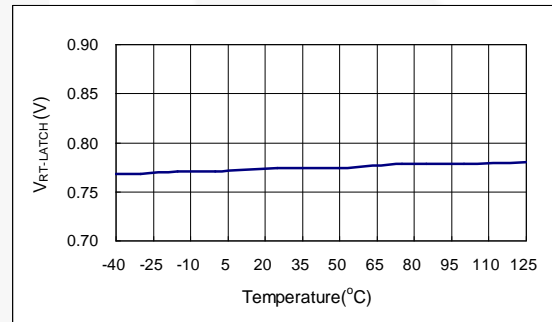

**Figure 24. Over-Temperature Protection Threshold Voltage of RT Pin**



## Functional Description

### PFC Stage

#### Multi-Vector Error Amplifier and THD Optimizer

For better dynamic performance, faster transient response, and precise clamping on PFC output, FAN6921AMR uses a transconductance-type amplifier with proprietary multi-vector error amplifier. The schematic diagram of this amplifier is shown in Figure 25. The PFC output voltage is detected from the INV pin by an external resistor divider circuit that consists of  $R_1$  and  $R_2$ . When PFC output variation voltage reaches 6% over or under the reference voltage 2.5 V, the multi-vector error amplifier adjusts its output sink or source current to increase the loop response to simplify the compensated circuit.

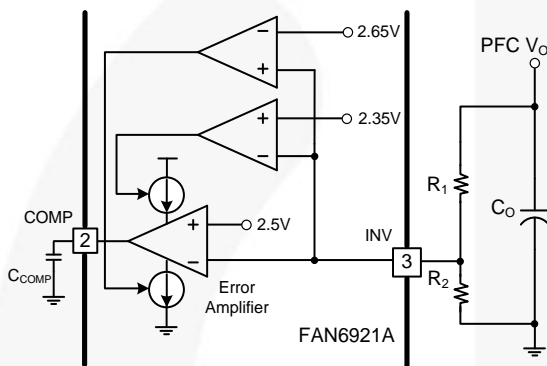

Figure 25. Multi-Vector Error Amplifier

The feedback voltage signal on the INV pin is compared with reference voltage 2.5 V, which makes the error amplifier source or sink current to charge or discharge its output capacitor  $C_{COMP}$ . The COMP voltage is compared with the internally generated sawtooth waveform to determine the on-time of PFC gate. Normally, with lower feedback loop bandwidth, the variation of the PFC gate on-time should be very small and almost constant within one input AC cycle. However, the power-factor-correction circuit operating at light-load condition has a defect, zero-crossing distortion; which distorts input current and makes the system's Total Harmonic Distortion (THD) worse. To improve the result of THD at light-load condition, especially at high input voltage, an innovative THD Optimizer is inserted by sampling the voltage across the current-sense resistor. This sampling voltage is added into the sawtooth waveform to modulate the on-time of PFC gate, so it is not constant on-time within a half AC cycle. The operation block between THD Optimizer and PWM is shown in Figure 26. After THD Optimizer processes, around the valley of AC input voltage, the compensated on-time becomes wider than the original. The PFC on-time, which is around the peak voltage, is narrowed by the THD Optimizer. The timing sequences of the PFC MOS and the shape of the inductor current are shown in Figure 27. Figure 28 shows the difference

between calculated fixed on-time mechanism and fixed on-time with THD Optimizer during a half AC cycle.

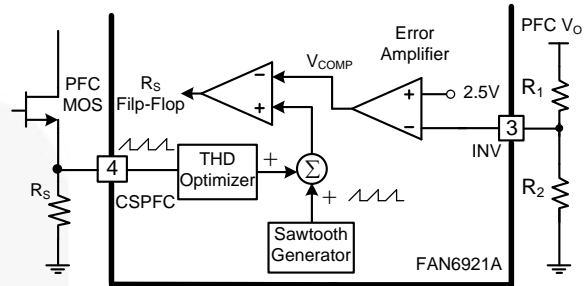

Figure 26. Multi-Vector Error Amplifier with THD Optimizer

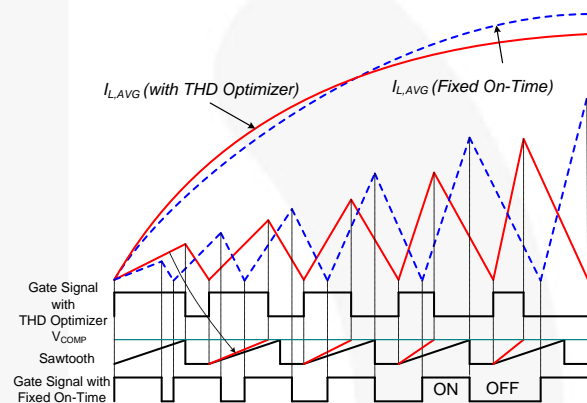

Figure 27. Operation Waveforms of Fixed On-Time with and without THD Optimizer

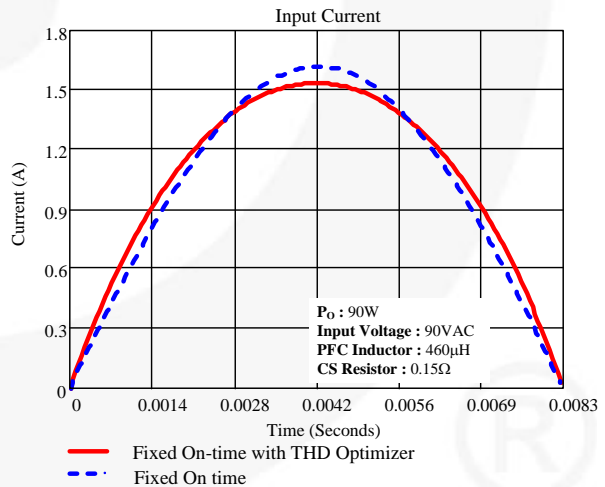
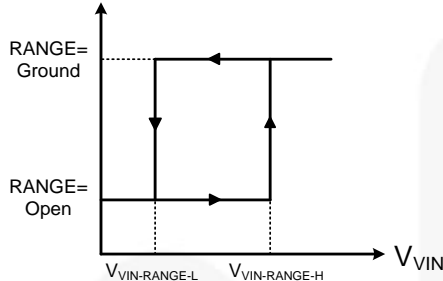

Figure 28. Calculated Waveforms of Fixed On-Time with and without THD Optimizer During a Half AC Cycle

### RANGE Pin

A built-in low voltage MOSFET can be turned on or off according to  $V_{VIN}$  voltage level. The drain pin of this internal MOSFET is connected to the RANGE pin. Figure 29 shows the status curve of  $V_{VIN}$  voltage level and RANGE impedance (open or ground).



**Figure 29. Hysteresis Behavior between RANGE Pin and VIN Pin Voltage**

### Zero-Current Detection (ZCD Pin)

Figure 30 shows the internal block of zero-current detection. The detection function is performed by sensing the information on an auxiliary winding of the PFC inductor. Referring to Figure 31, when the PFC MOS is off, the stored energy of the PFC inductor starts to release to the output load. Then the drain voltage of PFC MOS starts to decrease since the PFC inductor resonates with parasitic capacitance. Once the ZCD pin voltage is lower than the triggering voltage (1.75 V typical), the PFC gate signal is sent again to start a new switching cycle.

If PFC operation needs to be shut down due to abnormal conditions, pull the ZCD pin LOW, to a voltage under 0.2 V (typical), to activate the PFC-disable function to stop PFC switching.

For preventing excessive high-switching frequency at light load, a built-in inhibit timer is used to limit the minimum  $t_{OFF}$  time. Even if the ZCD signal has been detected, the PFC gate signal is not sent during the inhibit time (2.5  $\mu$ s typical).

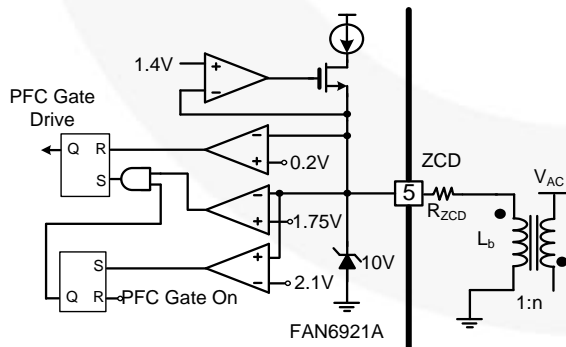

**Figure 30. Zero-Current Detection**

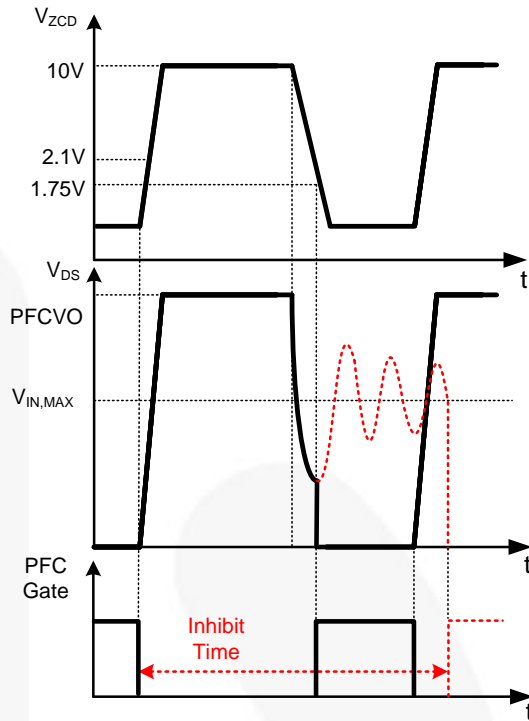

**Figure 31. Operation Waveforms of PFC Zero-Current Detection**

### Protection for PFC Stage

#### PFC Output Voltage OVP and UVP (INV Pin)

FAN6921AMR provides several kinds of protection for the PFC stage. PFC output over- and under-voltage are essential for the PFC stage. Both are detected and determined by INV pin voltage, as shown in Figure 32. When the INV pin voltage is over 2.75 V or under 0.45 V due to overshoot or abnormal conditions and lasts for a de-bounce time around 70 $\mu$ s, the OVP or UVP circuit is activated to stop PFC switching operation immediately.

The INV pin is not only used to receive and regulate PFC output voltage, but can also perform PFC output OVP/ UVP protection. For failure-mode test, this pin can shut down PFC switching if pin floating occurs.

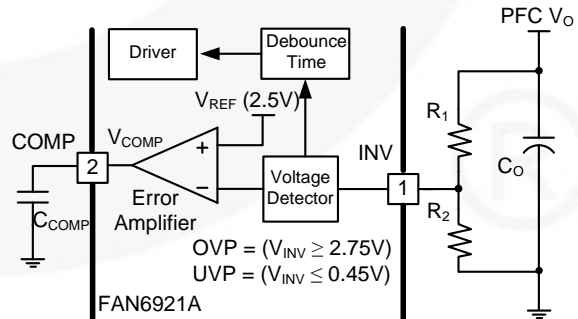

**Figure 32. PFC Over-and Under-Voltage Protection**

### PFC Peak Current Limiting (CSPFC Pin)

During PFC stage switching operation, the PFC switch current is detected by a current-sense resistor on the CSPFC pin and the detected voltage on this resistor is delivered to the input terminal of a comparator and compared with a threshold voltage of 0.82 V (typical). Once the CSPFC pin voltage is higher than the threshold voltage, the PFC gate is turned off immediately.

The PFC peak switching current is adjustable by the current-sense resistor. Figure 33 shows the measured waveform of PFC gate and CSPFC pin voltage.

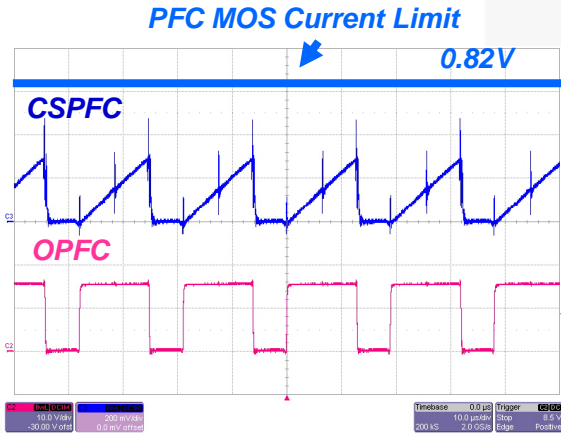

Figure 33. Cycle-by-Cycle Current Limiting

### Brown-In / Out Protection (VIN Pin)

With AC voltage detection, FAN6921AMR can perform brown-in / out protection (AC voltage UVP). Figure 34 shows the key operation waveforms of brown-in / out protection. Both use the VIN pin to detect AC input voltage level and the VIN pin is connected to AC input by a resistor divider (refer to Figure 1); therefore, the  $V_{VIN}$  voltage is proportional to the AC input voltage. When the AC voltage drops and  $V_{VIN}$  voltage is lower than 1 V for 100 ms, the UVP protection is activated and the COMP pin voltage is clamped around 1.6 V. Because PFC gate duty is determined by comparing the sawtooth waveform and COMP pin voltage, lower COMP voltage results in narrow PFC on-time, so that the energy converged is limited and the PFC output voltage decreases. When INV pin is lower than 1.2 V, FAN6921AMR stops all PFC and PWM switching operation immediately until  $V_{DD}$  voltage drops to turn-off voltage then rises to turn-on voltage again (UVLO).

When the brownout protection is activated, all switching operation is turned off, and  $V_{DD}$  voltage enters "Hiccup" mode going up and down continuously. Until  $V_{VIN}$  voltage is higher than 1.3 V (typical) and  $V_{DD}$  reaches turn-on voltage again, the PWM and PFC gate is sent out. The measured waveforms of brown-in / out protection are shown in Figure 35.

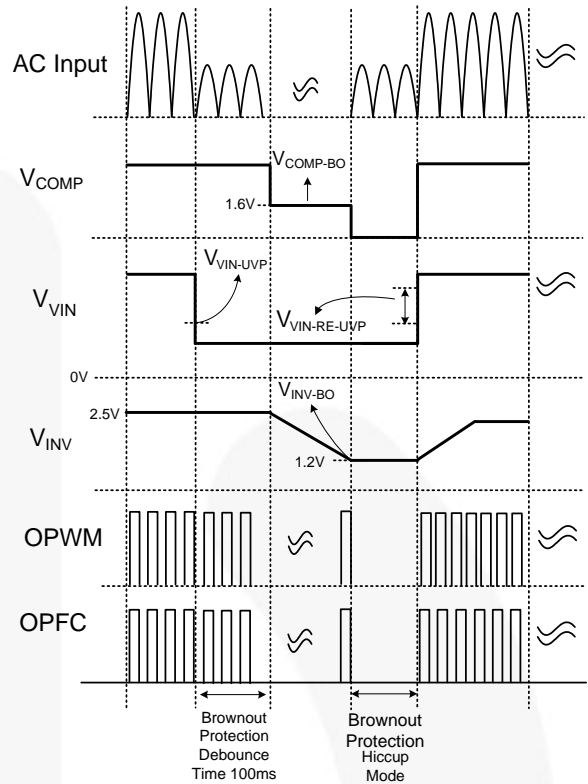

Figure 34. Operation Waveforms of Brown-In / Out Protection

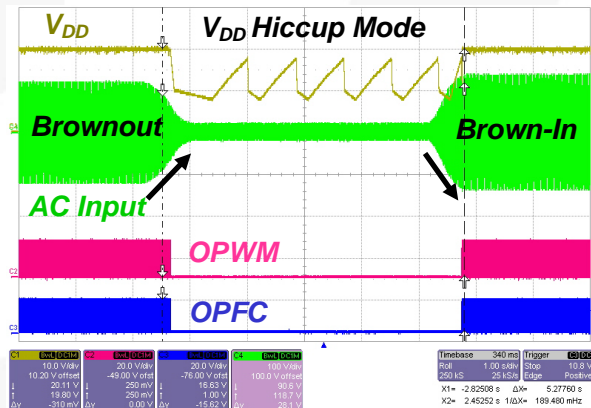

Figure 35. Measured Waveform of Brown-In / Out Protection (Adapter Application)

## PWM Stage

### HV Startup and Operating Current (HV Pin)

The HV pin is connected to the AC line through a resistor (refer to Figure 1). With a built-in high-voltage startup circuit, when AC voltage is applied to power system, FAN6921AMR provides a high current to charge external  $V_{DD}$  capacitor to reduce the controller's startup time and build up normal rated output voltage within three seconds. To save power consumption, after  $V_{DD}$  voltage exceeds turn-on voltage and enters normal operation; this high-voltage startup circuit is shut down to avoid power loss from the startup resistor.

Figure 36 shows the characteristic curve of  $V_{DD}$  voltage and operating current  $I_{DD}$ . When  $V_{DD}$  voltage is lower than  $V_{DD-PWM-OFF}$ , FAN6921AMR stops all switching operation and turns off some internal circuits to reduce operating current. By doing so, the period from  $V_{DD-PWM-OFF}$  to  $V_{DD-OFF}$  can be extended and the Hiccup Mode frequency can be decreased to reduce the input power in case of output short circuit. Figure 37 shows the typical waveforms of  $V_{DD}$  voltage and gate signal in Hiccup Mode.

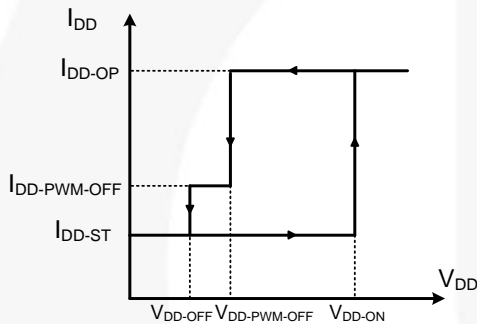

Figure 36.  $V_{DD}$  vs.  $I_{DD-OP}$  Characteristic Curve

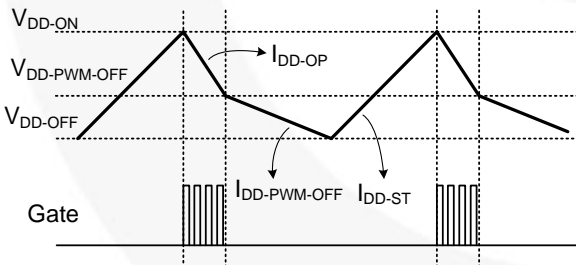

Figure 37. Typical Waveform of  $V_{DD}$  Voltage and Gate Signal in Hiccup Mode

### Green Mode and PFC-ON / OFF Control (FB Pin)

Green Mode is used to reduce power loss in the system (e.g. switching loss). An off-time modulation technique regulates switching frequency according to FB pin voltage. When output loading is decreased, FB voltage becomes lower due to secondary feedback movement and the  $t_{OFF-MIN}$  is extended. After  $t_{OFF-MIN}$  (determined by FB voltage), the internal valley-detection circuit is activated to detect the valley on the drain voltage of the PWM switch.

When the valley signal is detected, FAN6921AMR outputs PWM gate signal to turn on the switch and begin a new switching cycle.

With Green Mode and valley detection at light-load condition; the power system can perform extended valley switching in DCM operation and can further reduce switching loss for better conversion efficiency. The FB pin voltage versus  $t_{OFF-MIN}$  time characteristic curve is shown in Figure 38. Figure 38 shows,  $t_{OFF}$  time narrowed to 2.25 ms, which is around 440 Hz switching frequency.

Referring to Figure 1 and Figure 2, FB pin voltage is not only used to receive secondary feedback signal to determine gate on-time, but also determines PFC stage on or off status. At no-load or light-load conditions, if PFC stage is set to be off; that can reduce power consumption from the PFC stage switching device and increase conversion efficiency. When output loading is decreased, the FB pin voltage becomes lower and the FAN6921AMR can detect the output loading level according to the FB pin voltage to control the on / off status of the PFC part.

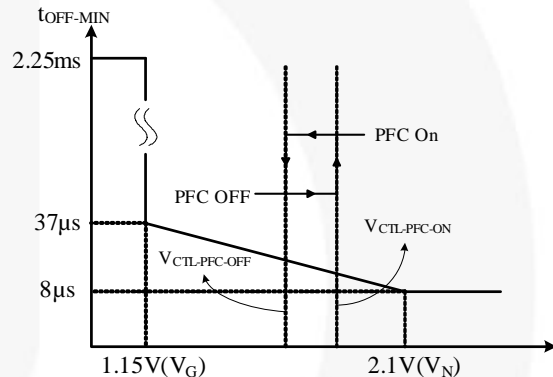
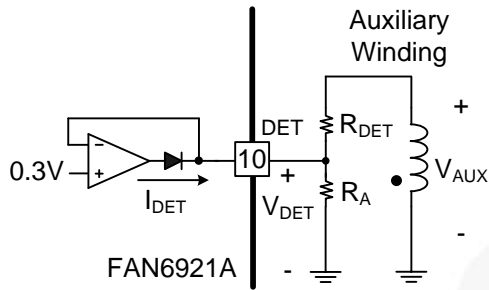

Figure 38.  $V_{FB}$  vs.  $t_{OFF-MIN}$  Characteristic Curve

### Valley Detection (DET Pin)

When FAN6921AMR operates in Green Mode,  $t_{OFF-MIN}$  time is determined by the Green-Mode circuit, according to FB pin voltage level. After  $t_{OFF-MIN}$ , the internal valley-detection circuit is activated. During the  $t_{OFF}$  time of PWM switch, when transformer inductor current discharges to zero; the transformer inductor and parasitic capacitor of PWM switch start to resonate concurrently. When the drain voltage on the PWM switch falls, the voltage across on auxiliary winding  $V_{AUX}$  also decreases since auxiliary winding is coupled to primary winding. Once the  $V_{AUX}$  voltage resonates and falls to negative,  $V_{DET}$  voltage is clamped by the DET pin (refer to Figure 39) and FAN6921AMR is forced to flow out a current  $I_{DET}$ . FAN6921AMR reflects and compares this  $I_{DET}$  current. If this source current rises to a threshold current, PWM gate signal is sent out after a fixed delay (200 ns typical).



**Figure 39. Valley Detection**

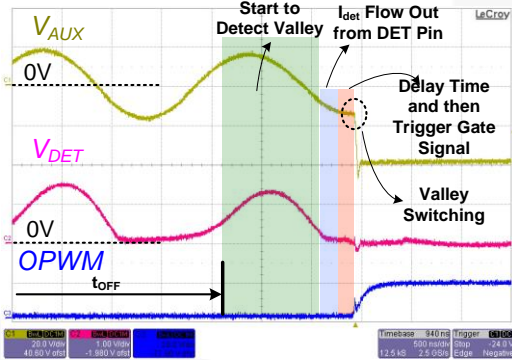

**Figure 40. Measured Waveform of Valley Detection**

### High / Low Line Over-Power Compensation (DET Pin)

Generally, when the power switch turns off, there is a delay from gate signal falling edge to power switch off. This delay is produced by an internal propagation delay of the controller and the turn-off delay of PWM switch due to gate resistor and gate-source capacitor  $C_{ISS}$  of PWM switch. At different AC input voltage, this delay produces different maximum output power under the same PWM current limit level. Higher input voltage generates higher maximum output power since applied voltage on primary winding is higher and causes a higher rising slope inductor current. It results in a higher peak inductor current at the same delay. Furthermore, under the same output wattage, the peak switching current at high line is lower than that at low line. Therefore, to make the maximum output power close at different input voltages, the controller needs to regulate  $V_{LIMIT}$  voltage of the CSPWM pin to control the PWM switch current.

Referring to Figure 41, during  $t_{ON}$  period of the PWM switch, the input voltage is applied to primary winding and the voltage across on auxiliary winding  $V_{AUX}$  is proportional to the primary winding voltage. As the input voltage increases, the reflected voltage on the auxiliary winding  $V_{AUX}$  becomes higher as well. FAN6921AMR also clamps the DET pin voltage and flows out a current  $I_{DET}$ . Since the current  $I_{DET}$  is in accordance with  $V_{AUX}$  voltage, FAN6921AMR can depend on this current  $I_{DET}$  during  $t_{ON}$  period to regulate the current-limit level of the PWM switch to perform high / low line over-power compensation.

As the input voltage increases, the reflected voltage on the auxiliary winding  $V_{AUX}$  becomes higher as well as the current  $I_{DET}$  and the controller regulates the  $V_{LIMIT}$  to a lower level.

The  $R_{DET}$  resistor is connected from the auxiliary winding to the DET pin. Engineers can adjust this  $R_{DET}$  resistor to get proper  $V_{LIMIT}$  voltage to fit power system needs. The characteristic curve of  $I_{DET}$  current vs.  $V_{LIMIT}$  voltage on CSPWM pin is shown in Figure 42.

$$I_{DET} = \left[ V_{IN} \times \left( \frac{N_A}{N_P} \right) \right] / R_{DET} \quad (1)$$

where  $V_{IN}$  is input voltage;  $N_A$  is turn number of auxiliary winding; and  $N_P$  is turn number of primary winding.

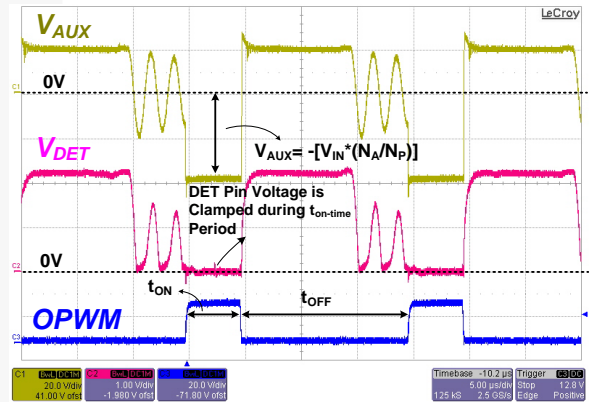

**Figure 41. Relationship between  $V_{AUX}$  and  $V_{IN}$**

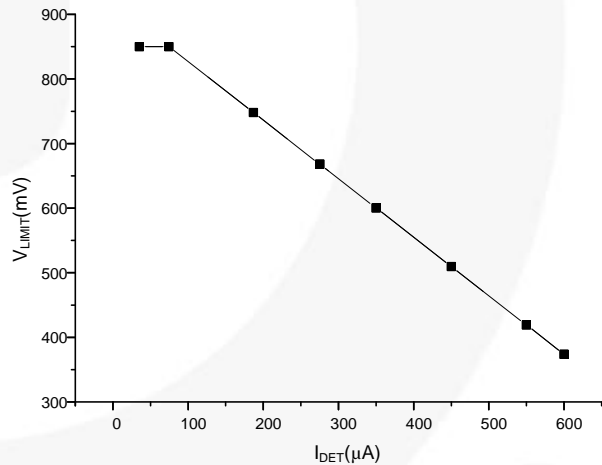

**Figure 42.  $I_{DET}$  vs.  $V_{LIMIT}$  Characteristic Curve**

### Leading-Edge Blanking (LEB)

When the PFC or PWM switches are turned on, a voltage spike is induced on the current-sense resistor due to the reciprocal effect by reverse-recovery energy of the output diode and  $C_{OSS}$  of power MOSFET. To prevent this spike, a leading-edge blanking time is built-in to FAN6921AMR and a small RC filter is recommended between the CSPWM pin and GND (e.g. 100  $\Omega$ , 470 pF).



## Protection for PWM Stage

### VDD Pin Over-Voltage Protection (OVP)

VDD over-voltage protection is used to prevent device damage once VDD voltage is higher than device stress rating voltage. In case of VDD OVP, the controller stops all switching operation immediately and enters Latch-Off Mode until the AC plug is disconnected.

### Adjustable Over-Temperature Protection and Externally Latch Triggering (RT Pin)

Figure 43 is a typical application circuit with an internal block of RT pin. As shown, a constant current IRT flows out from the RT pin, so the voltage VRT on RT pin can be obtained as IRT current multiplied by the resistor, which consists of NTC resistor and RA resistor. If the RT pin voltage is lower than 0.8 V and lasts for a debounce time, Latch Mode is activated and stops all PFC and PWM switching.

The RT pin is usually used to achieve over-temperature protection with a NTC resistor and provide external latch triggering for additional protection. Engineers can use an external triggering circuit (e.g. transistor) to pull the RT pin LOW and activate controller Latch Mode.

Generally, the external latch triggering needs to activate rapidly since it is usually used to protect power system from abnormal conditions. Therefore, the protection debounce time of the RT pin is set to around 110 μs once RT pin voltage is lower than 0.5 V.

For over-temperature protection, because the temperature does not change immediately; the RT pin voltage is reduced slowly as well. The debounce time for adjustable OTP does not need a fast reaction. To prevent improper latch triggering on the RT pin due to exacting test condition (e.g. lightning test); when the RT pin triggering voltage is higher than 0.5 V, the protection debounce time is set to around 10 ms. To avoid improper triggering on the RT pin, add a small value capacitor (e.g. 1000 pF) paralleled with NTC and RA resistor.

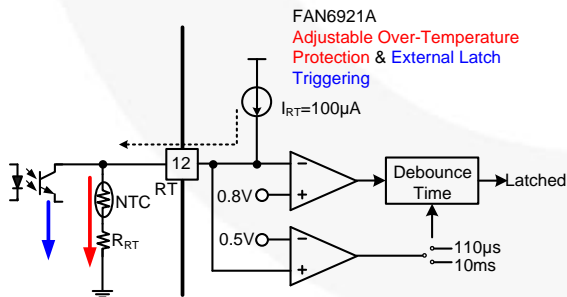

Figure 43. Adjustable Over-Temperature Protection

### Output Over-Voltage Protection (DET Pin)

Referring to Figure 44, during the discharge time of PWM transformer inductor; the voltage across on auxiliary winding is reflected from secondary winding and, therefore, the flat voltage on the DET pin is proportional to the output voltage. FAN6921AMR can sample this flat voltage level after a  $t_{OFF}$  blanking time to perform output over-voltage protection. This  $t_{OFF}$  blanking time is used to ignore the voltage ringing from leakage inductance of PWM transformer. The sampling flat voltage level is compared with internal threshold voltage 2.5 V and, once the protection is activated, FAN6921AMR enters Latch Mode.

The controller can protect rapidly through this kind of cycle-by-cycle sampling method in the case of output over voltage. The protection voltage level can be determined by the ratio of external resistor divider RA and RDET. The flat voltage on DET pin can be expressed by the following equation:

$$V_{DET} = (N_A / N_S) \times V_O \times \frac{R_A}{R_{DET} + R_A} \quad (2)$$

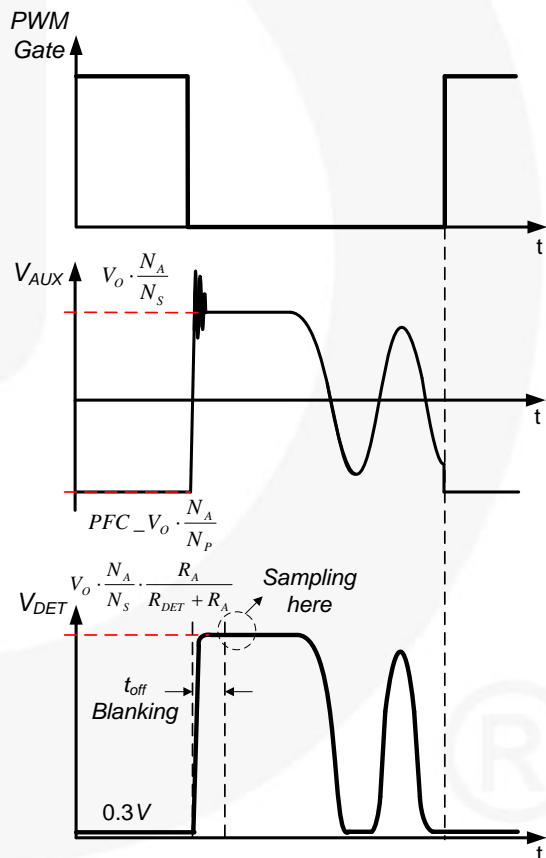
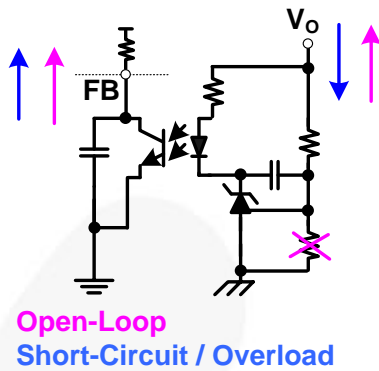

Figure 44. Operation Waveform of Output Over-Voltage Detection

**Open-Loop, Short-Circuit, and Overload Protection (FB Pin)**

Referring to Figure 45, outside of FAN6921AMR, the FB pin is connected to the collector of transistor of an optocoupler. Inside of FAN6921AMR, the FB pin is connected to an internal voltage bias through a resistor of around 5 kΩ.



**Figure 45. FB Pin Open-Loop, Short Circuit, and Overload Protection**

As the output loading is increased, the output voltage is decreased and the sink current of transistor of optocoupler on primary side is reduced so the FB pin voltage is increased by internal voltage bias. In the case of an open-loop, output short-circuit, or overload condition; this sink current is further reduced and the FB pin voltage is pulled to high level by internal bias voltage. When the FB pin voltage is higher than 4.2 V for 50 ms, the FB pin protection is activated.

**Under-Voltage Lockout (UVLO, VDD Pin)**

Referring to Figure 36 and Figure 37, the turn-on and turn-off  $V_{DD}$  threshold voltages of FAN6921AMR are fixed at 18 V and 10 V, respectively. During startup, the hold-up capacitor ( $V_{DD}$  cap.) is charged by the HV startup current until  $V_{DD}$  voltage reaches the turn-on voltage. Before the output voltage rises to rated voltage and delivers energy to the  $V_{DD}$  capacitor from auxiliary winding, this hold-up capacitor has to sustain the  $V_{DD}$  voltage energy for operation. When  $V_{DD}$  voltage reaches turn-on voltage, FAN6921AMR starts all switching operation if no protection is triggered before  $V_{DD}$  voltage drops to turn-off voltage  $V_{DD-PWM-OFF}$ .

## Physical Dimensions

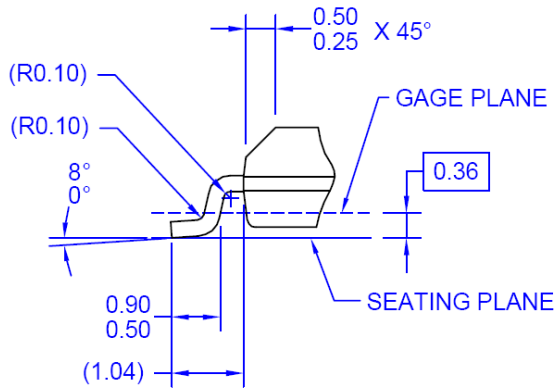
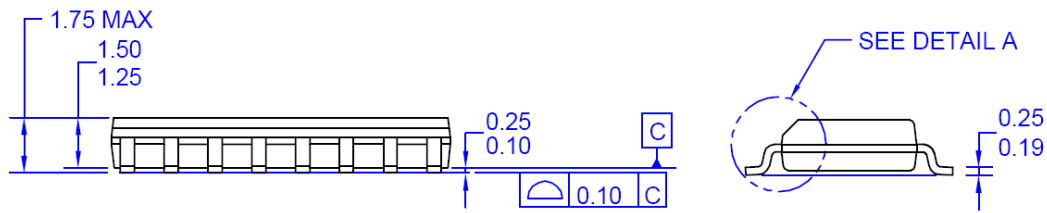
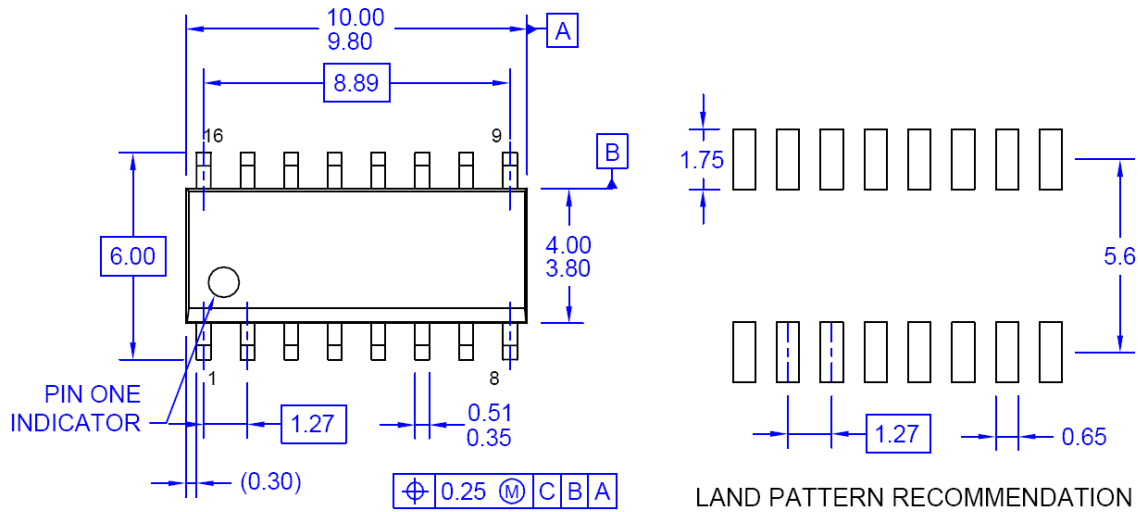

NOTES: UNLESS OTHERWISE SPECIFIED

- A) THIS PACKAGE CONFORMS TO JEDEC MS-012, VARIATION AC, ISSUE C.
- B) ALL DIMENSIONS ARE IN MILLIMETERS.
- C) DIMENSIONS ARE EXCLUSIVE OF BURRS, MOLD FLASH AND TIE BAR PROTRUSIONS
- D) CONFORMS TO ASME Y14.5M-1994
- E) LANDPATTERN STANDARD: SOIC127P600X175-16AM
- F) DRAWING FILE NAME: M16AREV12.

**DETAIL A**  
SCALE: 2:1

**Figure 46. 16-Pin Small Outline Package (SOP)**

Package drawings are provided as a service to customers considering Fairchild components. Drawings may change in any manner without notice. Please note the revision and/or date on the drawing and contact a Fairchild Semiconductor representative to verify or obtain the most recent revision. Package specifications do not expand the terms of Fairchild's worldwide terms and conditions, specifically the warranty therein, which covers Fairchild products.

Always visit Fairchild Semiconductor's online packaging area for the most recent package drawings:  
<http://www.fairchildsemi.com/packaging/>



**TRADEMARKS**

The following includes registered and unregistered trademarks and service marks, owned by Fairchild Semiconductor and/or its global subsidiaries, and is not intended to be an exhaustive list of all such trademarks.

2Cool™	FPS™		Sync-Lock™
AccuPower™	F-PFS™	PowerTrench®	
AX-CAP®	FRFET®	PowerXS™	TinyBoost™
BitSiC™	Global Power Resource™	Programmable Active Droop™	TinyBuck™
Build it Now™	GreenBridge™	QFET®	TinyCalc™
CorePLUS™	Green FPS™	QST™	TinyLogic®
CorePOWER™	Green FPS™ e-Series™	Quiet Series™	TINYOPTO™
CROSSVOL7™	Gmax™	RapidConfigure™	TinyPower™
CTL™	GTO™		TinyPWM™
Current Transfer Logic™	IntelliMAX™	Saving our world, 1mW/WkW at a time™	TinyWire™
DEUXPEED®	ISOPLANAR™	SignalWise™	TransiC™
Dual Cool™	Making Small Speakers Sound Louder and Better™	SmartMax™	TriFault Detect™
EcoSPARK®	MegaBuck™	SMART START™	TRUECURRENT®
EfficientMax™	MICROCOUPLER™	Solutions for Your Success™	µSerDes™
ESBC™	MicroFET™	SPM®	
	MicroPak™	STEALTH™	UHC®
Fairchild®	MicroPak2™	SuperFET®	Ultra FRFET™
Fairchild Semiconductor®	MillerDrive™	SuperSOT™-3	UniFET™
FACT Quiet Series™	MotionMax™	SuperSOT™-6	VCX™
FACT®	mWSaver™	SuperSOT™-8	VisualMax™
FAST®	OptoHiT™	SupreMOS®	VoltagePlus™
FastvCore™	OPTOLOGIC®	SyncFET™	XS™
FETBench™	OPTOPLANAR®		

\* Trademarks of System General Corporation, used under license by Fairchild Semiconductor.

**DISCLAIMER**

FAIRCHILD SEMICONDUCTOR RESERVES THE RIGHT TO MAKE CHANGES WITHOUT FURTHER NOTICE TO ANY PRODUCTS HEREIN TO IMPROVE RELIABILITY, FUNCTION, OR DESIGN. FAIRCHILD DOES NOT ASSUME ANY LIABILITY ARISING OUT OF THE APPLICATION OR USE OF ANY PRODUCT OR CIRCUIT DESCRIBED HEREIN, NEITHER DOES IT CONVEY ANY LICENSE UNDER ITS PATENT RIGHTS, NOR THE RIGHTS OF OTHERS. THESE SPECIFICATIONS DO NOT EXPAND THE TERMS OF FAIRCHILD'S WORLDWIDE TERMS AND CONDITIONS, SPECIFICALLY THE WARRANTY THEREIN, WHICH COVERS THESE PRODUCTS.

**LIFE SUPPORT POLICY**

FAIRCHILD'S PRODUCTS ARE NOT AUTHORIZED FOR USE AS CRITICAL COMPONENTS IN LIFE SUPPORT DEVICES OR SYSTEMS WITHOUT THE EXPRESS WRITTEN APPROVAL OF FAIRCHILD SEMICONDUCTOR CORPORATION.

As used herein:

- Life support devices or systems are devices or systems which, (a) are intended for surgical implant into the body or (b) support or sustain life, and (c) whose failure to perform when properly used in accordance with instructions for use provided in the labeling, can be reasonably expected to result in a significant injury of the user.
- A critical component in any component of a life support, device, or system whose failure to perform can be reasonably expected to cause the failure of the life support device or system, or to affect its safety or effectiveness.

**ANTI-COUNTERFEITING POLICY**

Fairchild Semiconductor Corporation's Anti-Counterfeiting Policy. Fairchild's Anti-Counterfeiting Policy is also stated on our external website, [www.fairchildsemi.com](http://www.fairchildsemi.com), under Sales Support.

Counterfeiting of semiconductor parts is a growing problem in the industry. All manufacturers of semiconductor products are experiencing counterfeiting of their parts. Customers who inadvertently purchase counterfeit parts experience many problems such as loss of brand reputation, substandard performance, failed applications, and increased cost of production and manufacturing delays. Fairchild is taking strong measures to protect ourselves and our customers from the proliferation of counterfeit parts. Fairchild strongly encourages customers to purchase Fairchild parts either directly from Fairchild or from Authorized Fairchild Distributors who are listed by country on our web page cited above. Products customers buy either from Fairchild directly or from Authorized Fairchild Distributors are genuine parts, have full traceability, meet Fairchild's quality standards for handling and storage and provide access to Fairchild's full range of up-to-date technical and product information. Fairchild and our Authorized Distributors will stand behind all warranties and will appropriately address any warranty issues that may arise. Fairchild will not provide any warranty coverage or other assistance for parts bought from Unauthorized Sources. Fairchild is committed to combat this global problem and encourage our customers to do their part in stopping this practice by buying direct or from authorized distributors.

**PRODUCT STATUS DEFINITIONS**
**Definition of Terms**

Datasheet Identification	Product Status	Definition
Advance Information	Formative / In Design	Datasheet contains the design specifications for product development. Specifications may change in any manner without notice.
Preliminary	First Production	Datasheet contains preliminary data; supplementary data will be published at a later date. Fairchild Semiconductor reserves the right to make changes at any time without notice to improve design.
No Identification Needed	Full Production	Datasheet contains final specifications. Fairchild Semiconductor reserves the right to make changes at any time without notice to improve the design.
Obsolete	Not In Production	Datasheet contains specifications on a product that is discontinued by Fairchild Semiconductor. The datasheet is for reference information only.

Rev. I64

ON Semiconductor and  are trademarks of Semiconductor Components Industries, LLC dba ON Semiconductor or its subsidiaries in the United States and/or other countries. ON Semiconductor owns the rights to a number of patents, trademarks, copyrights, trade secrets, and other intellectual property. A listing of ON Semiconductor's product/patent coverage may be accessed at [www.onsemi.com/site/pdf/Patent-Marking.pdf](http://www.onsemi.com/site/pdf/Patent-Marking.pdf). ON Semiconductor reserves the right to make changes without further notice to any products herein. ON Semiconductor makes no warranty, representation or guarantee regarding the suitability of its products for any particular purpose, nor does ON Semiconductor assume any liability arising out of the application or use of any product or circuit, and specifically disclaims any and all liability, including without limitation special, consequential or incidental damages. Buyer is responsible for its products and applications using ON Semiconductor products, including compliance with all laws, regulations and safety requirements or standards, regardless of any support or applications information provided by ON Semiconductor. "Typical" parameters which may be provided in ON Semiconductor data sheets and/or specifications can and do vary in different applications and actual performance may vary over time. All operating parameters, including "Typicals" must be validated for each customer application by customer's technical experts. ON Semiconductor does not convey any license under its patent rights nor the rights of others. ON Semiconductor products are not designed, intended, or authorized for use as a critical component in life support systems or any FDA Class 3 medical devices or medical devices with a same or similar classification in a foreign jurisdiction or any devices intended for implantation in the human body. Should Buyer purchase or use ON Semiconductor products for any such unintended or unauthorized application, Buyer shall indemnify and hold ON Semiconductor and its officers, employees, subsidiaries, affiliates, and distributors harmless against all claims, costs, damages, and expenses, and reasonable attorney fees arising out of, directly or indirectly, any claim of personal injury or death associated with such unintended or unauthorized use, even if such claim alleges that ON Semiconductor was negligent regarding the design or manufacture of the part. ON Semiconductor is an Equal Opportunity/Affirmative Action Employer. This literature is subject to all applicable copyright laws and is not for resale in any manner.

## PUBLICATION ORDERING INFORMATION

### LITERATURE FULFILLMENT:

Literature Distribution Center for ON Semiconductor  
19521 E. 32nd Pkwy, Aurora, Colorado 80011 USA  
**Phone:** 303-675-2175 or 800-344-3860 Toll Free USA/Canada  
**Fax:** 303-675-2176 or 800-344-3867 Toll Free USA/Canada  
**Email:** [orderlit@onsemi.com](mailto:orderlit@onsemi.com)

**N. American Technical Support:** 800-282-9855 Toll Free  
USA/Canada  
**Europe, Middle East and Africa Technical Support:**  
Phone: 421 33 790 2910  
**Japan Customer Focus Center**  
Phone: 81-3-5817-1050

**ON Semiconductor Website:** [www.onsemi.com](http://www.onsemi.com)  
**Order Literature:** <http://www.onsemi.com/orderlit>  
For additional information, please contact your local  
Sales Representative