



ON Semiconductor®

# FAN3121 / FAN3122

## Single 9-A High-Speed, Low-Side Gate Driver

FAN3121 / FAN3122 — Single 9-A High-Speed, Low-Side Gate Driver

### Features

- Industry-Standard Pin-out with Enable Input
- 4.5-V to 18-V Operating Range
- 11.4 A Peak Sink at  $V_{DD} = 12\text{ V}$
- 9.7-A Sink / 7.1-A Source at  $V_{OUT} = 6\text{ V}$
- Inverting Configuration (FAN3121) and Non-Inverting Configuration (FAN3122)
- Internal Resistors Turn Driver Off If No Inputs
- 23-ns / 19-ns Typical Rise/Fall Times (10 nF Load)
- 18 ns to 23 ns Typical Propagation Delay Time
- Choice of TTL or CMOS Input Thresholds
- MillerDrive™ Technology
- Available in Thermally Enhanced 3x3 mm 8-Lead MLP or 8-Lead SOIC Package (Pb-Free Finish)
- Rated from  $-40^{\circ}\text{C}$  to  $+125^{\circ}\text{C}$
- Automotive Qualified to AEC-Q100 (F085 Versions)

### Applications

- Synchronous Rectifier Circuits
- High-Efficiency MOSFET Switching
- Switch-Mode Power Supplies
- DC-to-DC Converters
- Motor Control
- Automotive-Qualified Systems (F085 Versions)

### Description

The FAN3121 and FAN3122 MOSFET drivers are designed to drive N-channel enhancement MOSFETs in low-side switching applications by providing high peak current pulses. The drivers are available with either TTL input thresholds (FAN312xT) or  $V_{DD}$ -proportional CMOS input thresholds (FAN312xC). Internal circuitry provides an under-voltage lockout function by holding the output low until the supply voltage is within the operating range.

FAN312x drivers incorporate the MillerDrive™ architecture for the final output stage. This bipolar / MOSFET combination provides the highest peak current during the Miller plateau stage of the MOSFET turn-on / turn-off process.

The FAN3121 and FAN3122 drivers implement an enable function on pin 3 (EN), previously unused in the industry-standard pin-out. The pin is internally pulled up to  $V_{DD}$  for active HIGH logic and can be left open for standard operation.

The commercial FAN3121/22 is available in a 3x3 mm 8-lead thermally-enhanced MLP package or an 8-lead SOIC package. The AEC-Q100 automotive-qualified versions are available in the 8-lead SOIC package.

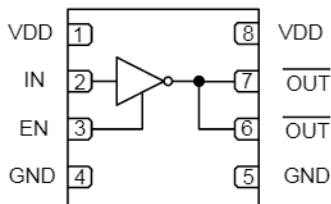


Figure 1. FAN3121 Pin Configuration

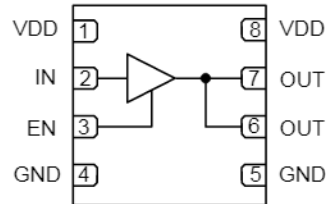


Figure 2. FAN3122 Pin Configuration

## Ordering Information

Part Number	Logic	Input Threshold	Package	Packing Method	Quantity per Reel
FAN3121CMPX	Inverting Channels + Enable	CMOS	3x3 mm MLP-8	Tape & Reel	3,000
FAN3121CMX			SOIC-8	Tape & Reel	2,500
FAN3121CMX-F085 <sup>(1)</sup>			SOIC-8	Tape & Reel	2,500
FAN3121TMPX		TTL	3x3 mm MLP-8	Tape & Reel	3,000
FAN3121TMX			SOIC-8	Tape & Reel	2,500
FAN3121TMX-F085 <sup>(1)</sup>			SOIC-8	Tape & Reel	2,500
FAN3122CMPX	Non-Inverting Channels + Enable	CMOS	3x3 mm MLP-8	Tape & Reel	3,000
FAN3122CMX			SOIC-8	Tape & Reel	2,500
FAN3122CMX-F085 <sup>(1)</sup>			SOIC-8	Tape & Reel	2,500
FAN3122TMPX		TTL	3x3 mm MLP-8	Tape & Reel	3,000
FAN3122TMX			SOIC-8	Tape & Reel	2,500
FAN3122TMX-F085 <sup>(1)</sup>			SOIC-8	Tape & Reel	2,500

### Note:

1. Qualified to AEC-Q100.

## Package Outlines

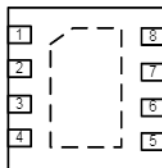


Figure 3. 3x3 mm MLP-8 (Top View)

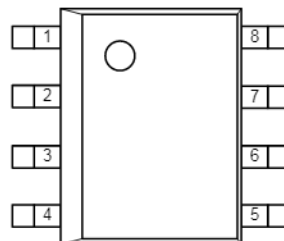


Figure 4. SOIC-8 (Top View)

## Thermal Characteristics<sup>(2)</sup>

Package	$\Theta_{JL}$ <sup>(3)</sup>	$\Theta_{JT}$ <sup>(4)</sup>	$\Theta_{JA}$ <sup>(5)</sup>	$\Psi_{JB}$ <sup>(6)</sup>	$\Psi_{JT}$ <sup>(7)</sup>	Units
8-Lead 3x3 mm Molded Leadless Package (MLP)	1.2	64	42	2.8	0.7	°C/W
8-Pin Small Outline Integrated Circuit (SOIC)	38	29	87	41	2.3	°C/W

### Notes:

2. Estimates derived from thermal simulation; actual values depend on the application.
3.  $\Theta_{JL}$  ( $\Theta_{JL}$ ): Thermal resistance between the semiconductor junction and the bottom surface of all the leads (including any thermal pad) that are typically soldered to a PCB.
4.  $\Theta_{JT}$  ( $\Theta_{JT}$ ): Thermal resistance between the semiconductor junction and the top surface of the package, assuming it is held at a uniform temperature by a top-side heatsink.
5.  $\Theta_{JA}$  ( $\Theta_{JA}$ ): Thermal resistance between junction and ambient, dependent on the PCB design, heat sinking, and airflow. The value given is for natural convection with no heatsink, as specified in JEDEC standards JESD51-2, JESD51-5, and JESD51-7, as appropriate.
6.  $\Psi_{JB}$  ( $\Psi_{JB}$ ): Thermal characterization parameter providing correlation between semiconductor junction temperature and an application circuit board reference point for the thermal environment defined in Note 5. For the MLP-8 package, the board reference is defined as the PCB copper connected to the thermal pad and protruding from either end of the package. For the SOIC-8 package, the board reference is defined as the PCB copper adjacent to pin 6.
7.  $\Psi_{JT}$  ( $\Psi_{JT}$ ): Thermal characterization parameter providing correlation between the semiconductor junction temperature and the center of the top of the package for the thermal environment defined in Note 5.

## Pin Definitions

FAN3121	FAN3122	Name	Description
3	3	EN	<b>Enable Input.</b> Pull pin LOW to inhibit driver. EN has logic thresholds for both TTL and CMOS IN thresholds.
4, 5	4, 5	GND	<b>Ground.</b> Common ground reference for input and output circuits.
2	2	IN	<b>Input.</b>
	6, 7	OUT	<b>Gate Drive Output.</b> Held LOW unless required input is present and $V_{DD}$ is above the UVLO threshold.
6, 7		$\overline{\text{OUT}}$	<b>Gate Drive Output</b> (inverted from the input). Held LOW unless required input is present and $V_{DD}$ is above the UVLO threshold.
1, 8	1, 8	$V_{DD}$	<b>Supply Voltage.</b> Provides power to the IC.
		P1	<b>Thermal Pad (MLP only).</b> Exposed metal on the bottom of the package; may be left floating or connected to GND; NOT suitable for carrying current.

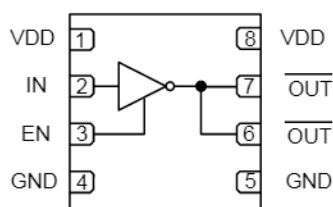


Figure 5. FAN3121 Pin Assignments (Repeated)

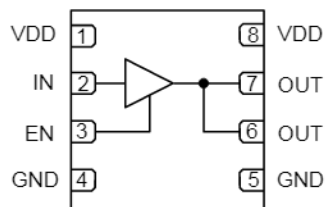


Figure 6. FAN3122 Pin Assignments (Repeated)

## Output Logic

FAN3121		
EN	IN	$\overline{\text{OUT}}$
0	0	0
0	1 <sup>(8)</sup>	0
1 <sup>(8)</sup>	0	1
1 <sup>(8)</sup>	1 <sup>(8)</sup>	0

FAN3122		
EN	IN	OUT
0	0 <sup>(8)</sup>	0
0	1	0
1 <sup>(8)</sup>	0 <sup>(8)</sup>	0
1 <sup>(8)</sup>	1	1

**Note:**

8. Default input signal if no external connection is made.

### Block Diagram

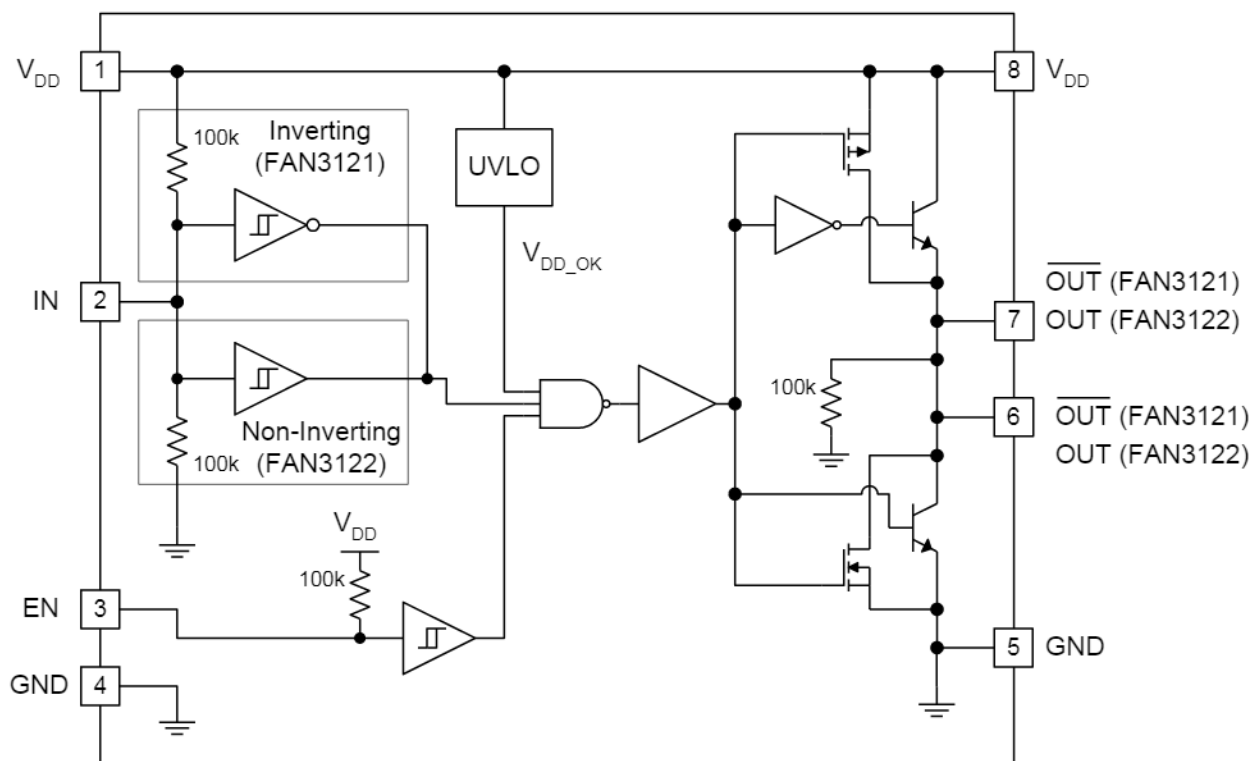


Figure 7. Block Diagram

### Absolute Maximum Ratings

Stresses exceeding the absolute maximum ratings may damage the device. The device may not function or be operable above the recommended operating conditions and stressing the parts to these levels is not recommended. In addition, extended exposure to stresses above the recommended operating conditions may affect device reliability. The absolute maximum ratings are stress ratings only.

Symbol	Parameter	Min.	Max.	Unit
$V_{DD}$	$V_{DD}$ to GND	-0.3	20.0	V
$V_{EN}$	EN to GND	GND - 0.3	$V_{DD} + 0.3$	V
$V_{IN}$	IN to GND	GND - 0.3	$V_{DD} + 0.3$	V
$V_{OUT}$	OUT to GND	GND - 0.3	$V_{DD} + 0.3$	V
$T_L$	Lead Soldering Temperature (10 Seconds)		+260	°C
$T_J$	Junction Temperature	-55	+150	°C
$T_{STG}$	Storage Temperature	-65	+150	°C

## Recommended Operating Conditions

The Recommended Operating Conditions table defines the conditions for actual device operation. Recommended operating conditions are specified to ensure optimal performance to the datasheet specifications. ON Semiconductor does not recommend exceeding them or designing to Absolute Maximum Ratings.

Symbol	Parameter	Min.	Max.	Unit
V <sub>DD</sub>	Supply Voltage Range	4.5	18.0	V
V <sub>EN</sub>	Enable Voltage EN	0	V <sub>DD</sub>	V
V <sub>IN</sub>	Input Voltage IN	0	V <sub>DD</sub>	V
T <sub>A</sub>	Operating Ambient Temperature	-40	+125	°C

## Electrical Characteristics

Unless otherwise noted, V<sub>DD</sub>=12 V and T<sub>J</sub>=-40°C to +125°C. Currents are defined as positive into the device and negative out of the device.

Symbol	Parameter	Conditions	Min.	Typ.	Max.	Unit
<b>Supply</b>						
V <sub>DD</sub>	Operating Range		4.5		18.0	V
I <sub>DD</sub>	Supply Current, Inputs / EN Not Connected	TTL		0.65	0.90	mA
		CMOS <sup>(9)</sup>		0.58	0.85	
V <sub>ON</sub>	Device Turn-On Voltage (UVLO)		3.5	4.0	4.3	V
V <sub>OFF</sub>	Device Turn-Off Voltage (UVLO)		3.30	3.75	4.10	V
FAN3121-F085, FAN3122-F085 (Automotive-Qualified Versions)						
V <sub>DD</sub>	Operating Range		4.5		18.0	V
I <sub>DD</sub>	Supply Current, Inputs / EN Not Connected	TTL		0.65	1.00	mA
		CMOS <sup>(9)</sup>		0.58	0.85	
V <sub>ON</sub>	Device Turn-On Voltage (UVLO)		3.5	4.0	4.3	V
V <sub>OFF</sub>	Device Turn-Off Voltage (UVLO) <sup>(13)</sup>		3.25	3.75	4.15	V
<b>Inputs (TTL, FAN312xT)<sup>(10)</sup></b>						
V <sub>IL_T</sub>	INx Logic Low Threshold		0.8	1.0		V
V <sub>IH_T</sub>	INx Logic High Threshold			1.7	2.0	V
V <sub>HYS_T</sub>	TTL Logic Hysteresis Voltage		0.40	0.70	0.85	V
FAN3121TMX, FAN3122TMX						
I <sub>IN+</sub>	Non-Inverting Input Current	IN from 0 to V <sub>DD</sub>	-1		175	μA
I <sub>IN-</sub>	Inverting Input Current	IN from 0 to V <sub>DD</sub>	-175		1	μA
FAN3121TMX-F085, FAN3122TMX-F085 (Automotive-Qualified Versions)						
I <sub>INx_T</sub>	Non-inverting Input Current <sup>(13)</sup>	IN=0 V	-1.5		1.5	μA
I <sub>INx_T</sub>	Non-inverting Input Current <sup>(13)</sup>	IN=V <sub>DD</sub>	90	120	175	μA
I <sub>INx_T</sub>	Inverting Input Current <sup>(13)</sup>	IN=0 V	-175	-120	-90	μA
I <sub>INx_T</sub>	Inverting Input Current <sup>(13)</sup>	IN=V <sub>DD</sub>	-1.5		1.5	μA

Symbol	Parameter	Conditions	Min.	Typ.	Max.	Unit
<b>Inputs (CMOS, FAN312xC)<sup>(10)</sup></b>						
V <sub>IL_C</sub>	INx Logic Low Threshold		30	38		%V <sub>DD</sub>
V <sub>IH_C</sub>	INx Logic High Threshold			55	70	%V <sub>DD</sub>
V <sub>HYS_C</sub>	CMOS Logic Hysteresis Voltage		12	17	24	%V <sub>DD</sub>
<b>FAN3121CMX, FAN3122CMX</b>						
I <sub>IN+</sub>	Non-Inverting Input Current	IN from 0 to V <sub>DD</sub>	-1		175	μA
I <sub>IN-</sub>	Inverting Input Current	IN from 0 to V <sub>DD</sub>	-175		1	μA
<b>FAN3121CMX-F085, FAN3122CMX-F085 (Automotive-Qualified Versions)</b>						
I <sub>INx_C</sub>	Non-Inverting Input Current <sup>(13)</sup>	IN=0 V	-1.5		1.5	μA
I <sub>INx_C</sub>	Non-Inverting Input Current <sup>(13)</sup>	IN=V <sub>DD</sub>	90	120	175	μA
I <sub>INx_C</sub>	Inverting Input Current <sup>(13)</sup>	IN=0 V	-175	-120	-90	μA
I <sub>INx_C</sub>	Inverting Input Current <sup>(13)</sup>	IN=V <sub>DD</sub>	-1.5		1.5	μA

### Electrical Characteristics (Continued)

Unless otherwise noted, V<sub>DD</sub>=12 V and T<sub>J</sub>=-40°C to +125°C. Currents are defined as positive into the device and negative out of the device.

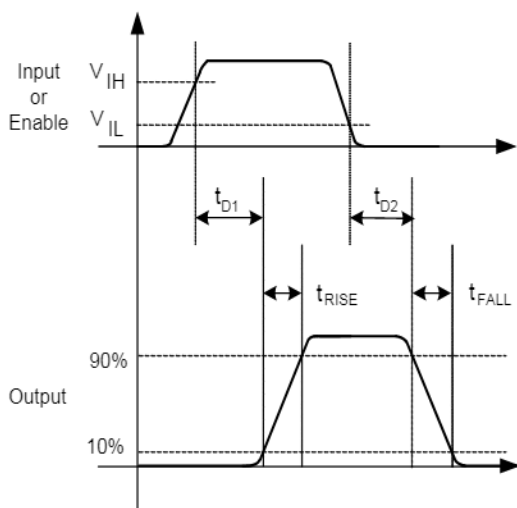
Symbol	Parameter	Conditions	Min.	Typ.	Max.	Unit
<b>ENABLE (FAN3121, FAN3122)</b>						
V <sub>ENL</sub>	Enable Logic Low Threshold	EN from 5 V to 0 V	1.2	1.6	2.0	V
V <sub>ENH</sub>	Enable Logic High Threshold	EN from 0 V to 5 V	1.8	2.2	2.6	V
V <sub>HYS_T</sub>	TTL Logic Hysteresis Voltage		0.2	0.6	0.8	V
R <sub>PU</sub>	Enable Pull-up Resistance		68	100	134	k
t <sub>D1</sub> , t <sub>D2</sub>	Propagation Delay, CMOS EN <sup>(11)</sup>		8	17	27	ns
t <sub>D1</sub> , t <sub>D2</sub>	Propagation Delay, TTL EN <sup>(11)</sup>		14	21	33	ns
<b>ENABLE (FAN3121-F085, FAN3122-F085) (Automotive-Qualified Versions)</b>						
V <sub>ENL</sub>	Enable Logic Low Threshold	EN from 5 V to 0 V	1.2	1.6	2.0	V
V <sub>ENH</sub>	Enable Logic High Threshold	EN from 0 V to 5 V	1.8	2.2	2.6	V
V <sub>HYS_T</sub>	TTL Logic Hysteresis Voltage		0.20	0.60	0.85	V
R <sub>PU</sub>	Enable Pull-up Resistance		68	100	134	k
t <sub>D1</sub> , t <sub>D2</sub>	Propagation Delay, CMOS EN <sup>(11)</sup>		6	17	35	ns
t <sub>D1</sub> , t <sub>D2</sub>	Propagation Delay, TTL EN <sup>(11)</sup>		8	22	34	ns
<b>Outputs</b>						
I <sub>SINK</sub>	OUT Current, Mid-Voltage, Sinking <sup>(12)</sup>	OUT at V <sub>DD</sub> /2, C <sub>LOAD</sub> =1.0 μF, f=1 kHz		9.7		A
I <sub>SOURCE</sub>	OUT Current, Mid-Voltage, Sourcing <sup>(12)</sup>	OUT at V <sub>DD</sub> /2, C <sub>LOAD</sub> =1.0 μF, f=1 kHz		7.1		A
I <sub>PK_SINK</sub>	OUT Current, Peak, Sinking <sup>(12)</sup>	C <sub>LOAD</sub> =1.0 μF, f=1 kHz		11.4		A
I <sub>PK_SOURCE</sub>	OUT Current, Peak, Sourcing <sup>(12)</sup>	C <sub>LOAD</sub> =1.0 μF, f=1 kHz		10.6		A
t <sub>RISE</sub>	Output Rise Time <sup>(11)</sup>	C <sub>LOAD</sub> =10 nF	18	23	29	ns
t <sub>FALL</sub>	Output Fall Time <sup>(11)</sup>	C <sub>LOAD</sub> =10 nF	11	19	27	ns
t <sub>D1</sub> , t <sub>D2</sub>	Output Propagation Delay, CMOS Inputs <sup>(11)</sup>	0 – 12 V <sub>IN</sub> , 1 V/ns Slew Rate	9	18	28	ns
t <sub>D1</sub> , t <sub>D2</sub>	Output Propagation Delay, TTL Inputs <sup>(11)</sup>	0 – 5 V <sub>IN</sub> , 1 V/ns Slew Rate	9	23	35	ns
I <sub>RVS</sub>	Output Reverse Current Withstand <sup>(12)</sup>		1500			mA

Symbol	Parameter	Conditions	Min.	Typ.	Max.	Unit
FAN3121-F085, FAN3122-F085 (Automotive-Qualified Versions)						
$t_{RISE}$	Output Rise Time <sup>(11)</sup> CMOS Inputs	$C_{LOAD}=10\text{ nF}$	12	23	31	ns
$t_{FALL}$	Output Fall Time <sup>(11)</sup> CMOS Inputs	$C_{LOAD}=10\text{ nF}$	12	19	27	ns
$t_{RISE}$	Output Rise Time <sup>(11)</sup> TTL Inputs	$C_{LOAD}=10\text{ nF}$	18	23	36	ns
$t_{FALL}$	Output Fall Time <sup>(11)</sup> TTL Inputs	$C_{LOAD}=10\text{ nF}$	10	19	28	ns
$t_{D1}, t_{D2}$	Output Propagation Delay, CMOS Inputs <sup>(13)</sup>	$0 - 12\text{ V}_{IN}, 1\text{ V/ns Slew Rate}$	6	18	35	ns
$t_{D1}, t_{D2}$	Output Propagation Delay, TTL Inputs <sup>(11)</sup>	$0 - 5\text{ V}_{IN}, 1\text{ V/ns Slew Rate}$	9	23	36	ns
$V_{OH}$	High Level Output Voltage <sup>(13)</sup>	$V_{OH}=V_{DD}-V_{OUT}, I_{OUT}=-1\text{ mA}$		15	35	mV
$V_{OL}$	Low Level Output Voltage <sup>(13)</sup>	$I_{OUT}=1\text{ mA}$		10	25	mV

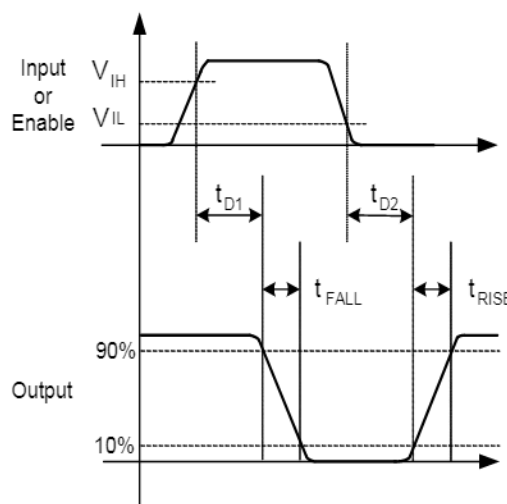
**Notes:**

- 9. Lower supply current due to inactive TTL circuitry.
- 10. EN inputs have modified TTL thresholds; refer to the ENABLE section.
- 11. See *Timing Diagrams of Figure 8 and Figure 9.*
- 12. Not tested in production.
- 13. Automotive-qualified F085 version specifications.

**Timing Diagrams**



**Figure 8. Non-Inverting**



**Figure 9. Inverting**

## Typical Performance Characteristics

Typical characteristics are provided at 25°C and  $V_{DD}=12\text{ V}$  unless otherwise noted.

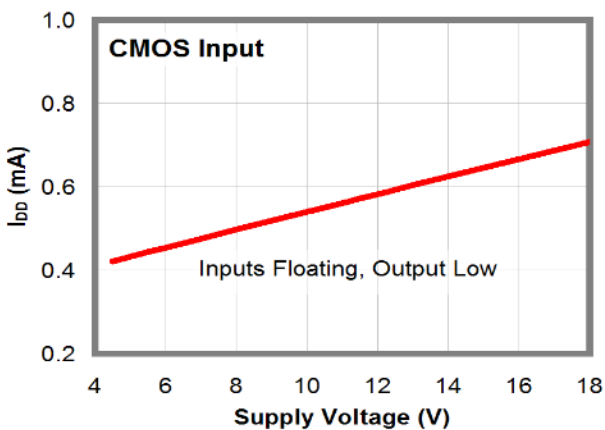


Figure 10.  $I_{DD}$  (Static) vs. Supply Voltage<sup>(14)</sup>

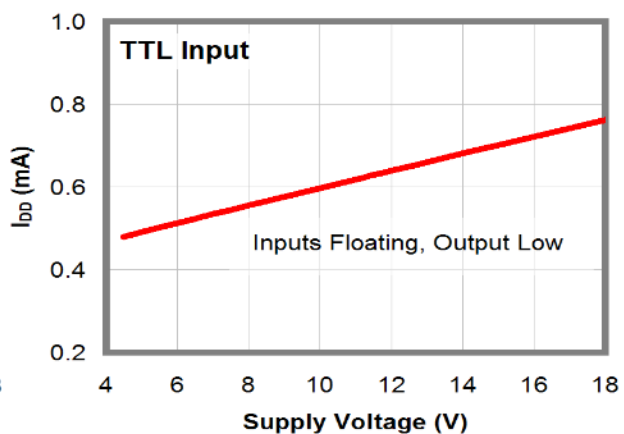


Figure 11.  $I_{DD}$  (Static) vs. Supply Voltage<sup>(14)</sup>

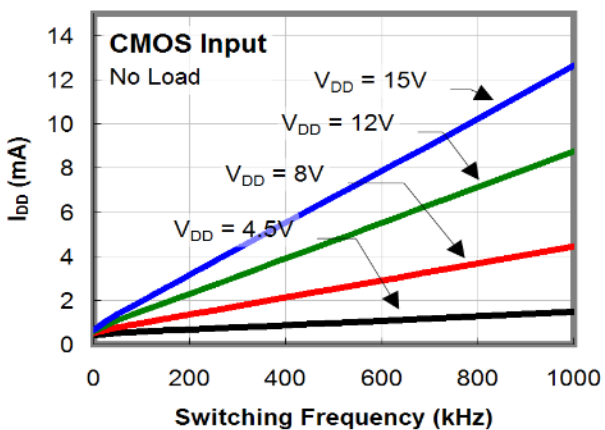


Figure 12.  $I_{DD}$  (No-Load) vs. Frequency

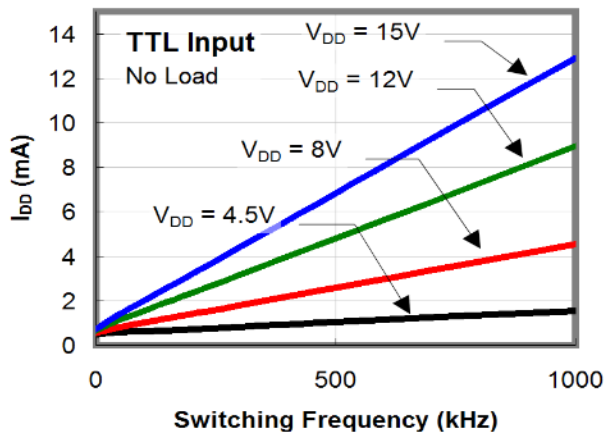


Figure 13.  $I_{DD}$  (No-Load) vs. Frequency

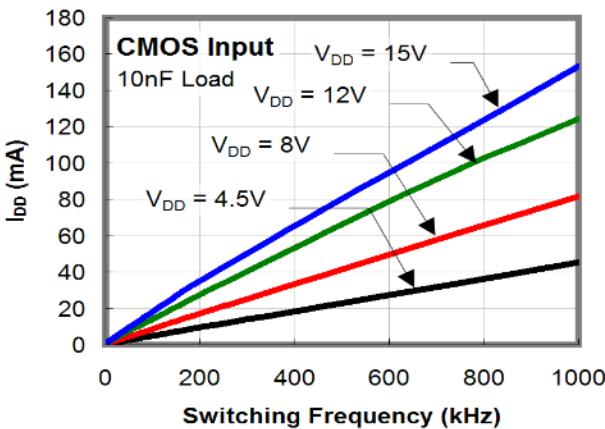


Figure 14.  $I_{DD}$  (10 nF Load) vs. Frequency

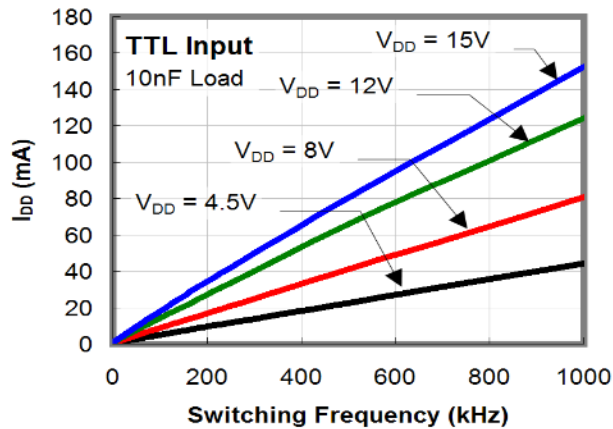


Figure 15.  $I_{DD}$  (10 nF Load) vs. Frequency



## Typical Performance Characteristics

Typical characteristics are provided at 25°C and  $V_{DD}=12\text{ V}$  unless otherwise noted.

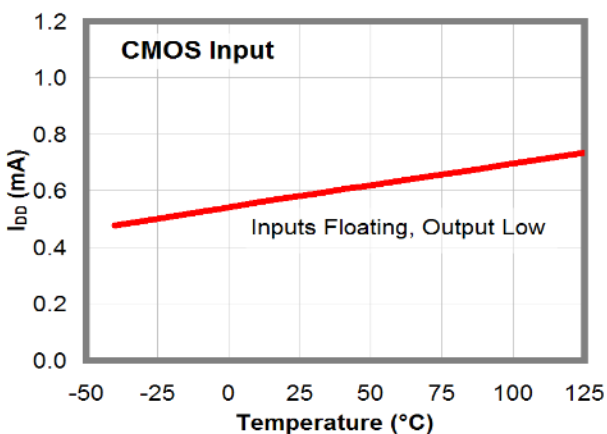


Figure 16.  $I_{DD}$  (Static) vs. Temperature<sup>(14)</sup>

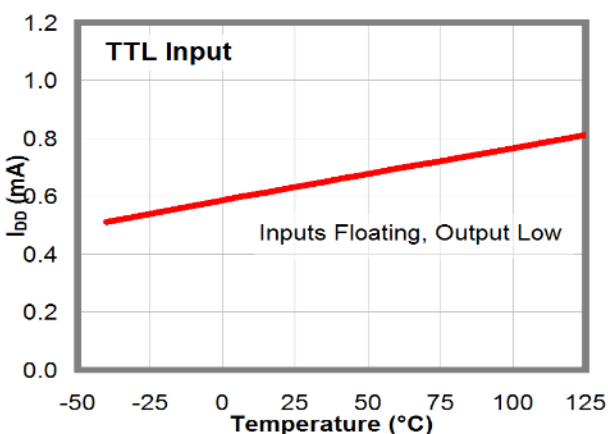


Figure 17.  $I_{DD}$  (Static) vs. Temperature<sup>(14)</sup>

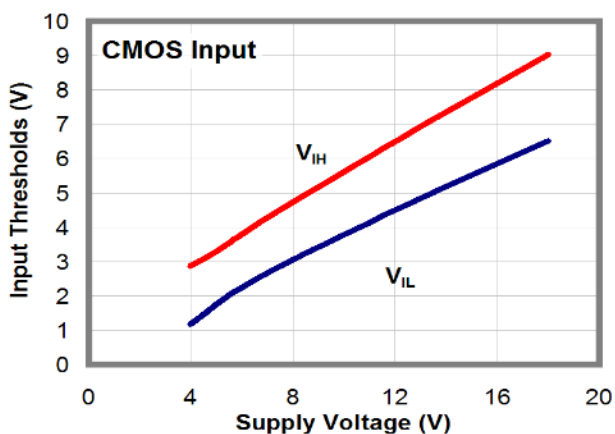


Figure 18. Input Thresholds vs. Supply Voltage

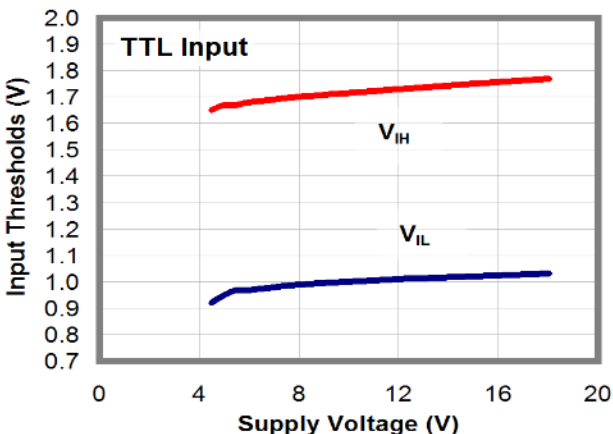


Figure 19. Input Thresholds vs. Supply Voltage

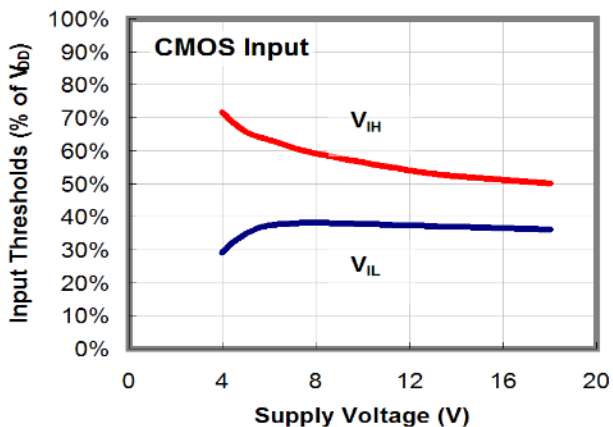


Figure 20. Input Thresholds % vs. Supply Voltage

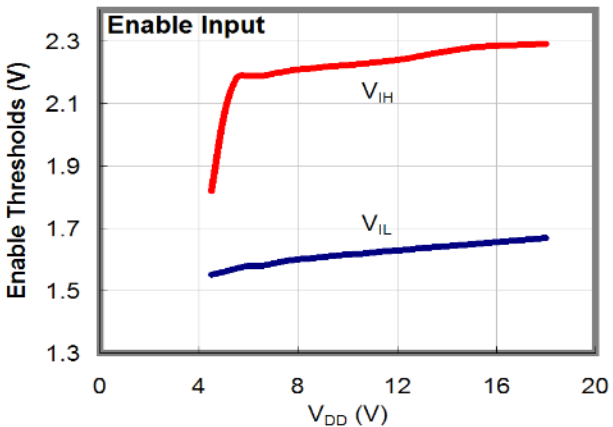


Figure 21. Enable Thresholds vs. Supply Voltage

## Typical Performance Characteristics

Typical characteristics are provided at 25°C and  $V_{DD}=12\text{ V}$  unless otherwise noted.

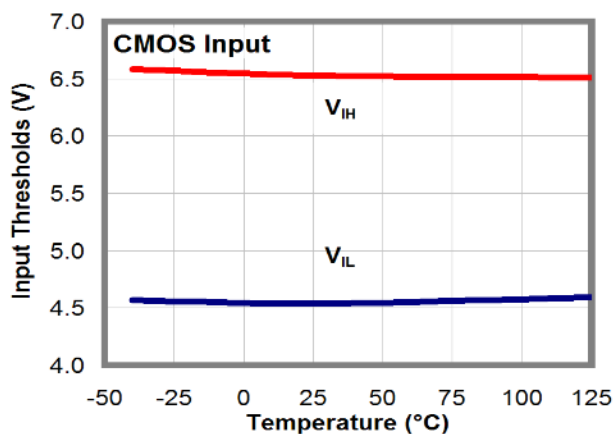


Figure 22. CMOS Input Thresholds vs. Temperature

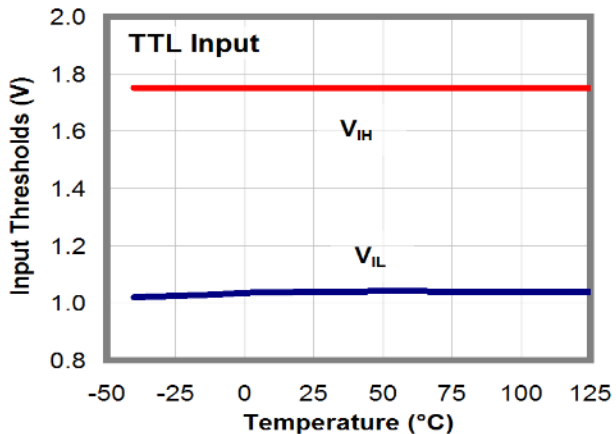


Figure 23. TTL Input Thresholds vs. Temperature

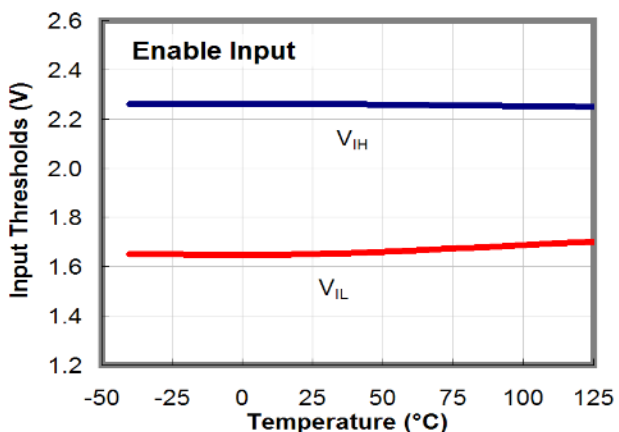


Figure 24. Enable Thresholds vs. Temperature

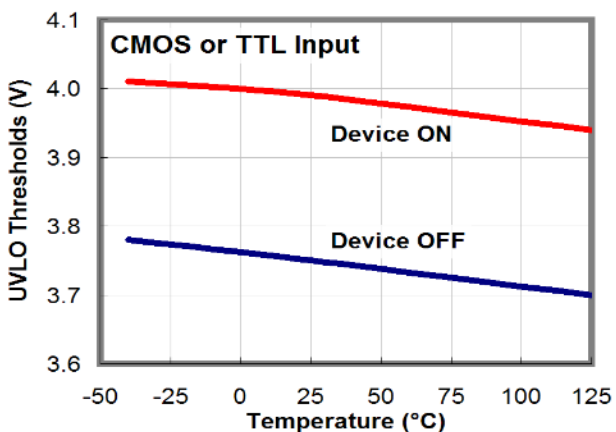


Figure 25. UVLO Thresholds vs. Temperature

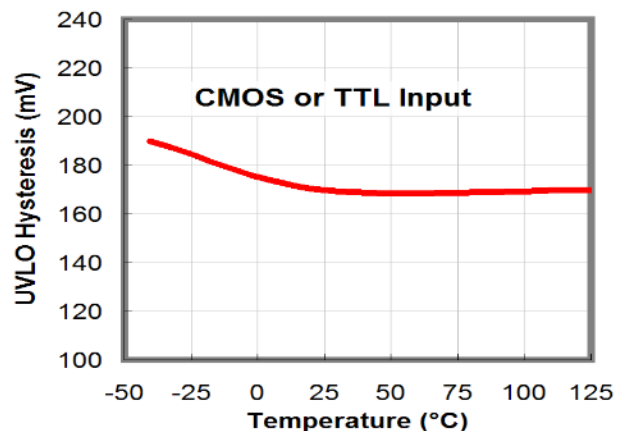


Figure 26. UVLO Hysteresis vs. Temperature

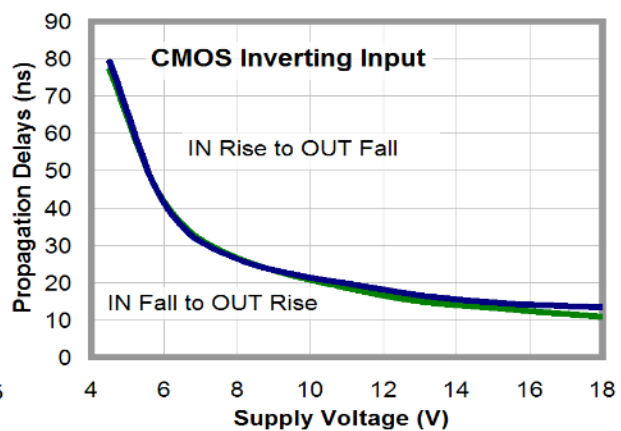


Figure 27. Propagation Delay vs. Supply Voltage

### Typical Performance Characteristics

Typical characteristics are provided at 25°C and  $V_{DD}=12\text{ V}$  unless otherwise noted.

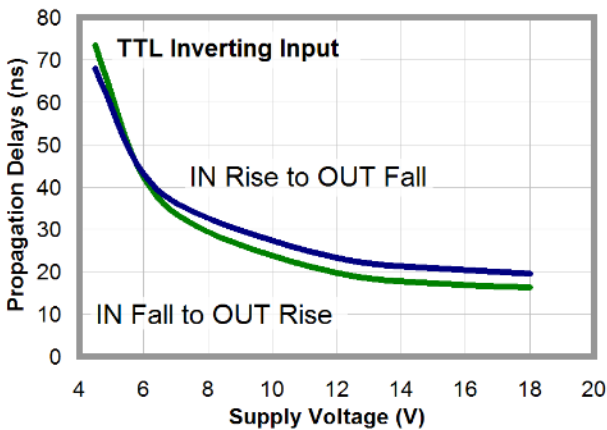


Figure 28. Propagation Delay vs. Supply Voltage

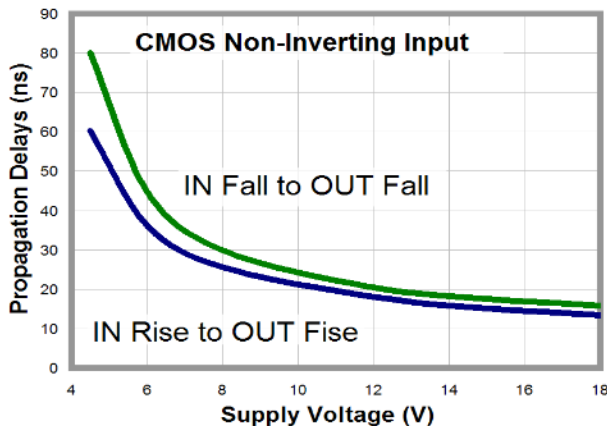


Figure 29. Propagation Delay vs. Supply Voltage

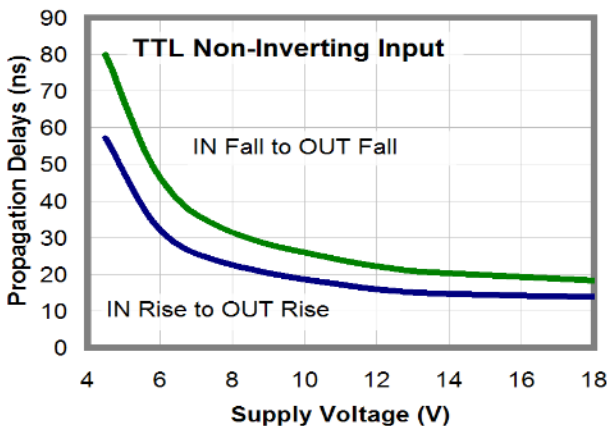


Figure 30. Propagation Delay vs. Supply Voltage

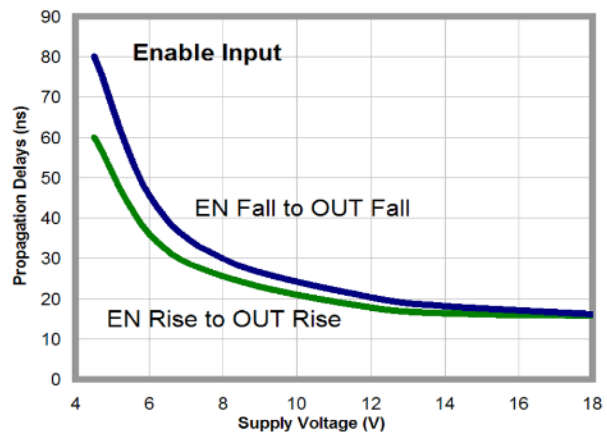


Figure 31. Propagation Delay vs. Supply Voltage

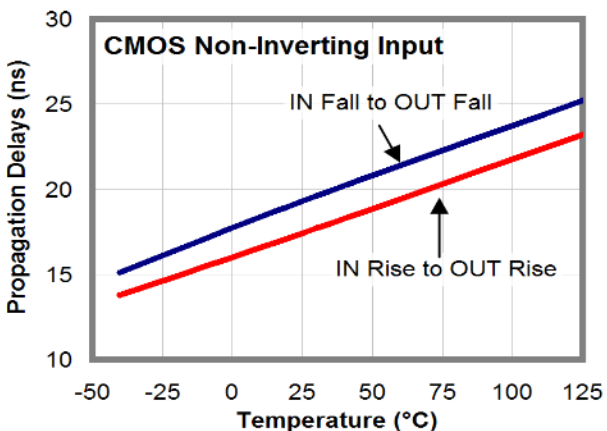


Figure 32. Propagation Delays vs. Temperature

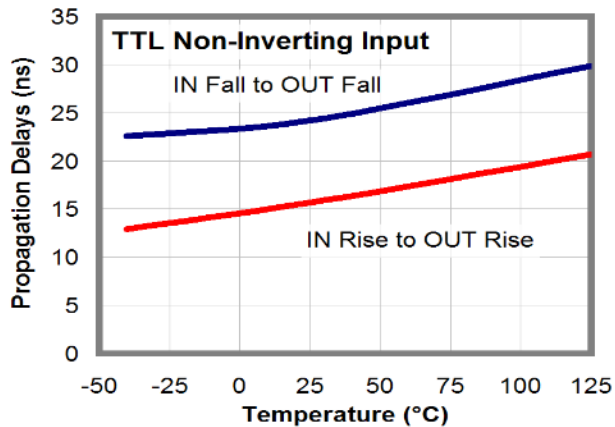


Figure 33. Propagation Delays vs. Temperature

## Typical Performance Characteristics

Typical characteristics are provided at 25°C and  $V_{DD}=12\text{ V}$  unless otherwise noted.

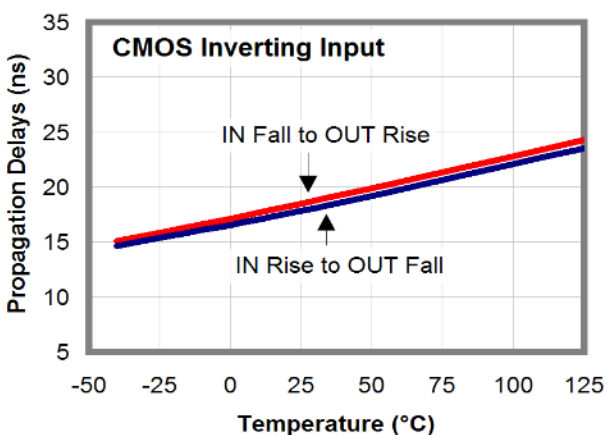


Figure 34. Propagation Delays vs. Temperature

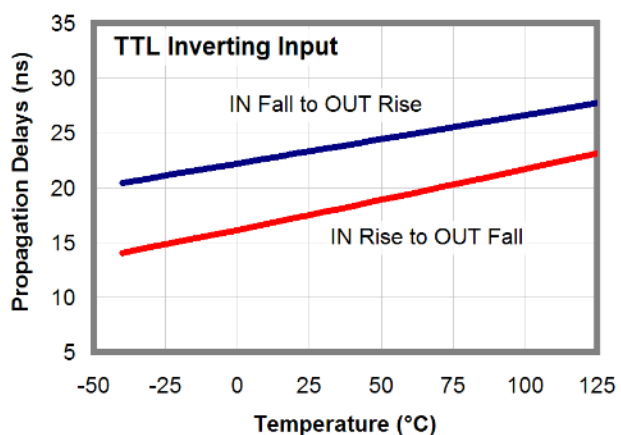


Figure 35. Propagation Delays vs. Temperature

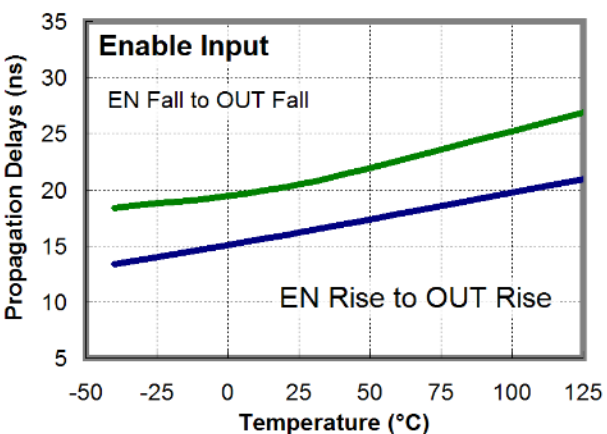


Figure 36. Propagation Delays vs. Temperature

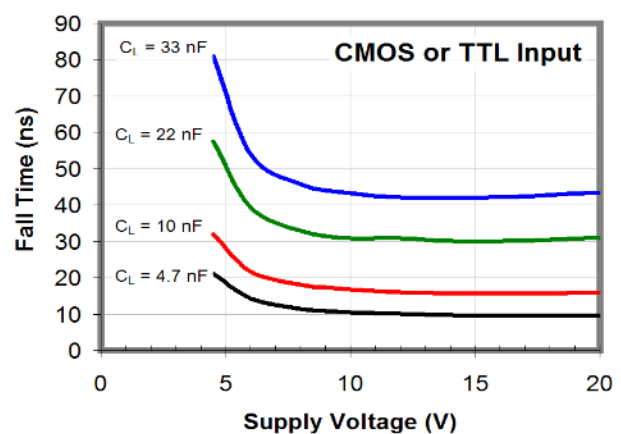


Figure 37. Fall Time vs. Supply Voltage

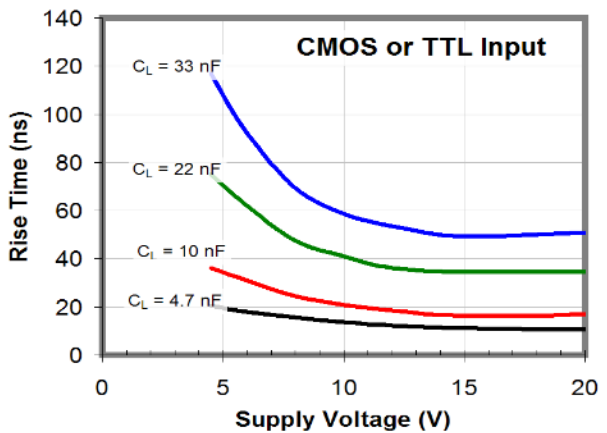


Figure 38. Rise Time vs. Supply Voltage

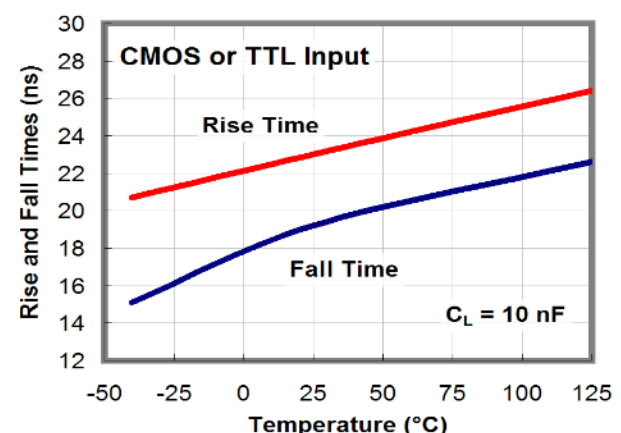


Figure 39. Rise and Fall Time vs. Temperature

## Typical Performance Characteristics

Typical characteristics are provided at 25°C and  $V_{DD}=12\text{ V}$  unless otherwise noted.

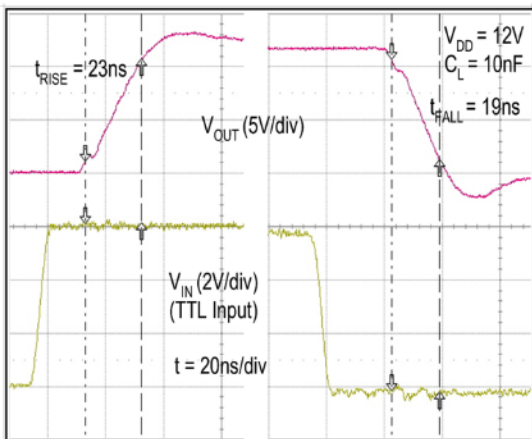


Figure 40. Rise / Fall Waveforms with 10 nF Load

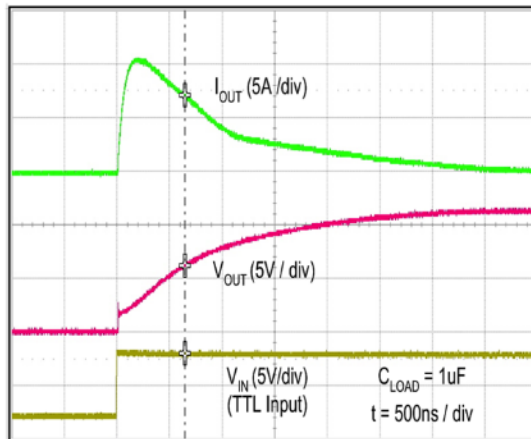


Figure 41. Quasi-Static Source Current with  $V_{DD}=12\text{V}$ <sup>(15)</sup>

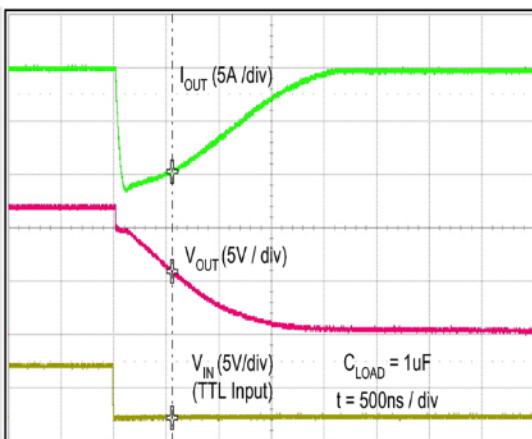


Figure 42. Quasi-Static Sink Current with  $V_{DD}=12\text{ V}$ <sup>(15)</sup>

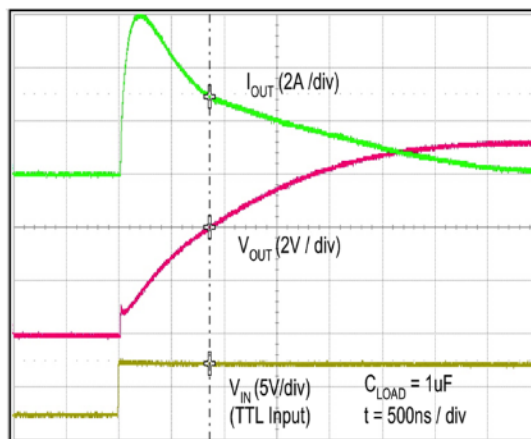


Figure 43. Quasi-Static Source Current with  $V_{DD}=8\text{ V}$ <sup>(15)</sup>

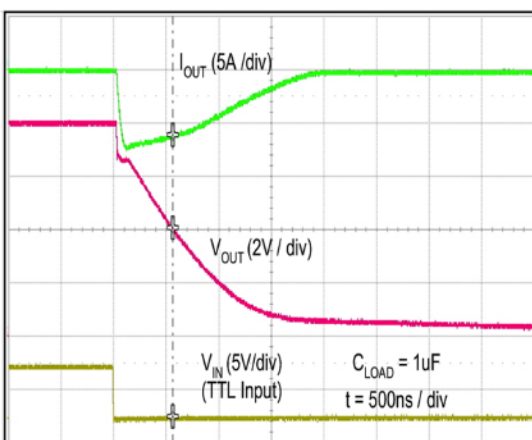


Figure 44. Quasi-Static Sink Current with  $V_{DD}=8\text{ V}$ <sup>(15)</sup>

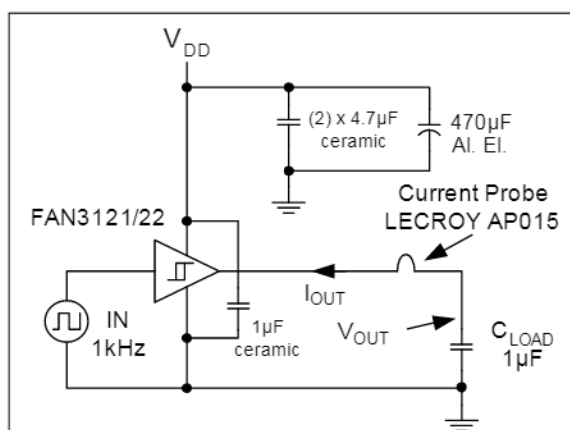


Figure 45. Quasi-Static  $I_{OUT}$  /  $V_{OUT}$  Test Circuit

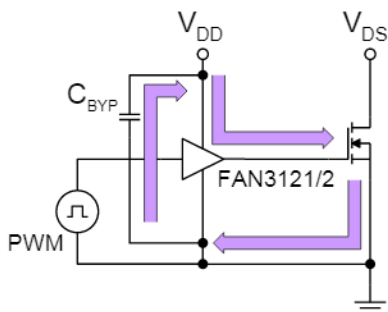
### Notes:

14. For any inverting inputs pulled LOW, non-inverting inputs pulled HIGH, or outputs driven HIGH; static  $I_{DD}$  increases by the current flowing through the corresponding pull-up/down resistor, shown in Figure 7.
15. The initial spike in each current waveform is a measurement artifact caused by the stray inductance of the current-measurement loop.



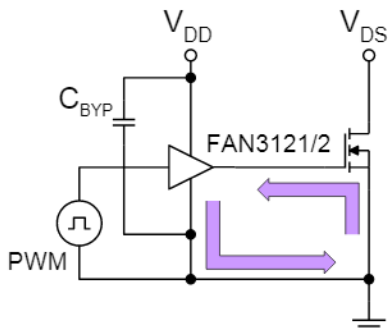


Figure 47 shows the pulsed gate drive current path when the gate driver is supplying gate charge to turn the MOSFET on. The current is supplied from the local bypass capacitor  $C_{BYP}$  and flows through the driver to the MOSFET gate and to ground. To reach the high peak currents possible with the FAN312x family, the resistance and inductance in the path should be minimized. The localized  $C_{BYP}$  acts to contain the high peak current pulses within this driver-MOSFET circuit, preventing them from disturbing the sensitive analog circuitry in the PWM controller.



**Figure 47. Current Path for MOSFET Turn-On**

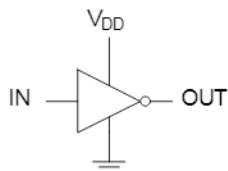
Figure 48 shows the path the current takes when the gate driver turns the MOSFET off. Ideally, the driver shunts the current directly to the source of the MOSFET in a small circuit loop. For fast turn-off times, the resistance and inductance in this path should be minimized.



**Figure 48. Current Path for MOSFET Turn-Off**

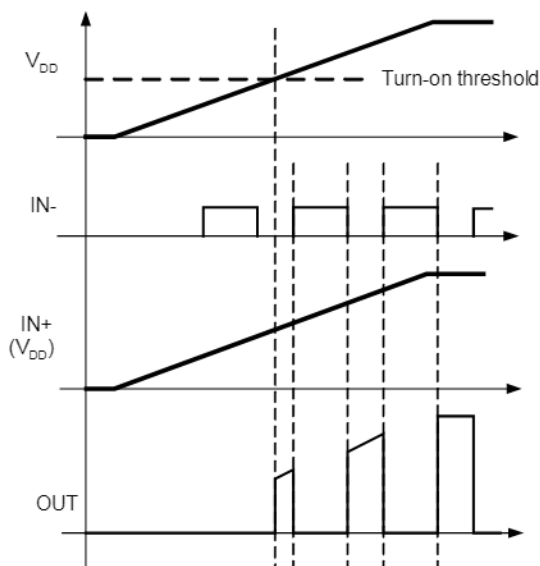
### Operational Waveforms

At power up, the FAN3121 inverting driver shown in Figure 49 holds the output LOW until the  $V_{DD}$  voltage reaches the UVLO turn-on threshold, as indicated in Figure 50. This facilitates proper startup control of low-side N-channel MOSFETs.



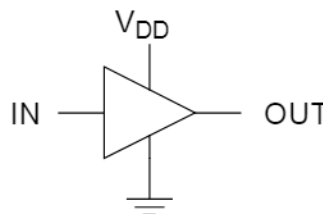
**Figure 49. Inverting Configuration**

The OUT pulses' magnitude follows  $V_{DD}$  magnitude with the output polarity inverted from the input until steady-state  $V_{DD}$  is reached.

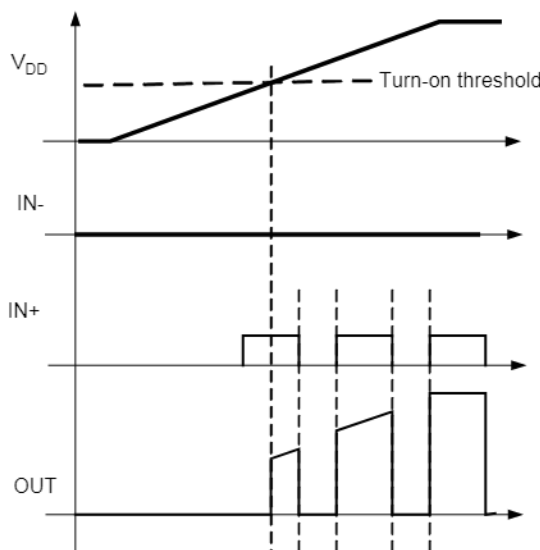


**Figure 50. Inverting Startup Waveforms**

At power up, the FAN3122 non-inverting driver, shown in Figure 51, holds the output LOW until the  $V_{DD}$  voltage reaches the UVLO turn-on threshold, as indicated in Figure 52. The OUT pulses magnitude follow  $V_{DD}$  magnitude until steady-state  $V_{DD}$  is reached.



**Figure 51. Non-Inverting Driver**



**Figure 52. Non-Inverting Startup Waveforms**

## Thermal Guidelines

Gate drivers used to switch MOSFETs and IGBTs at high frequencies can dissipate significant amounts of power. It is important to determine the driver power dissipation and the resulting junction temperature in the application to ensure that the part is operating within acceptable temperature limits.

The total power dissipation in a gate driver is the sum of two components,  $P_{GATE}$  and  $P_{DYNAMIC}$ :

$$P_{TOTAL} = P_{GATE} + P_{DYNAMIC} \quad (1)$$

**Gate Driving Loss:** The most significant power loss results from supplying gate current (charge per unit time) to switch the load MOSFET on and off at the switching frequency. The power dissipation that results from driving a MOSFET at a specified gate-source voltage,  $V_{GS}$ , with gate charge,  $Q_G$ , at switching frequency,  $f_{SW}$ , is determined by:

$$P_{GATE} = Q_G \cdot V_{GS} \cdot f_{SW} \quad (2)$$

**Dynamic Pre-drive / Shoot-through Current:** A power loss resulting from internal current consumption under dynamic operating conditions, including pin pull-up / pull-down resistors, can be obtained using the "IDD (No-Load) vs. Frequency" graphs in Typical Performance Characteristics to determine the current  $I_{DYNAMIC}$  drawn from  $V_{DD}$  under actual operating conditions:

$$P_{DYNAMIC} = I_{DYNAMIC} \cdot V_{DD} \quad (3)$$

Once the power dissipated in the driver is determined, the driver junction rise with respect to circuit board can be evaluated using the following thermal equation, assuming  $\psi_{JB}$  was determined for a similar thermal design (heat sinking and air flow):

$$T_J = P_{TOTAL} \cdot \psi_{JB} + T_B \quad (4)$$

where:

$T_J$  = driver junction temperature;

$\psi_{JB}$  = (psi) thermal characterization parameter relating temperature rise to total power dissipation; and

$T_B$  = board temperature in location as defined in the Thermal Characteristics table.

In a full-bridge synchronous rectifier application, shown in Figure 53, each FAN3122 drives a parallel combination of two high-current MOSFETs, (such as FDMS8660S). The typical gate charge for each SR MOSFET is 70 nC with  $V_{GS} = V_{DD} = 9$  V. At a switching frequency of 300 kHz, the total power dissipation is:

$$P_{GATE} = 2 \cdot 70 \text{ nC} \cdot 9 \text{ V} \cdot 300 \text{ kHz} = 0.378 \text{ W} \quad (5)$$

$$P_{DYNAMIC} = 2 \text{ mA} \cdot 9 \text{ V} = 18 \text{ mW} \quad (6)$$

$$P_{TOTAL} = 0.396 \text{ W} \quad (7)$$

The SOIC-8 has a junction-to-board thermal characterization parameter of  $\psi_{JB} = 42^\circ\text{C/W}$ . In a system application, the localized temperature around the device is a function of the layout and construction of the PCB along with airflow across the surfaces. To ensure reliable operation, the maximum junction temperature of the device must be prevented from exceeding the maximum rating of  $150^\circ\text{C}$ ; with 80% derating,  $T_J$  would be limited to  $120^\circ\text{C}$ . Rearranging Equation 4 determines the board temperature required to maintain the junction temperature below  $120^\circ\text{C}$ :

$$T_{B,MAX} = T_J - P_{TOTAL} \cdot \psi_{JB} \quad (8)$$

$$T_{B,MAX} = 120^\circ\text{C} - 0.396 \text{ W} \cdot 42^\circ\text{C/W} = 104^\circ\text{C} \quad (9)$$

For comparison, replace the SOIC-8 used in the previous example with the 3x3 mm MLP package with  $\psi_{JB} = 2.8^\circ\text{C/W}$ . The 3x3 mm MLP package can operate at a PCB temperature of  $118^\circ\text{C}$ , while maintaining the junction temperature below  $120^\circ\text{C}$ . This illustrates that the physically smaller MLP package with thermal pad offers a more conductive path to remove the heat from the driver. Consider tradeoffs between reducing overall circuit size with junction temperature reduction for increased reliability.



Typical Application Diagrams

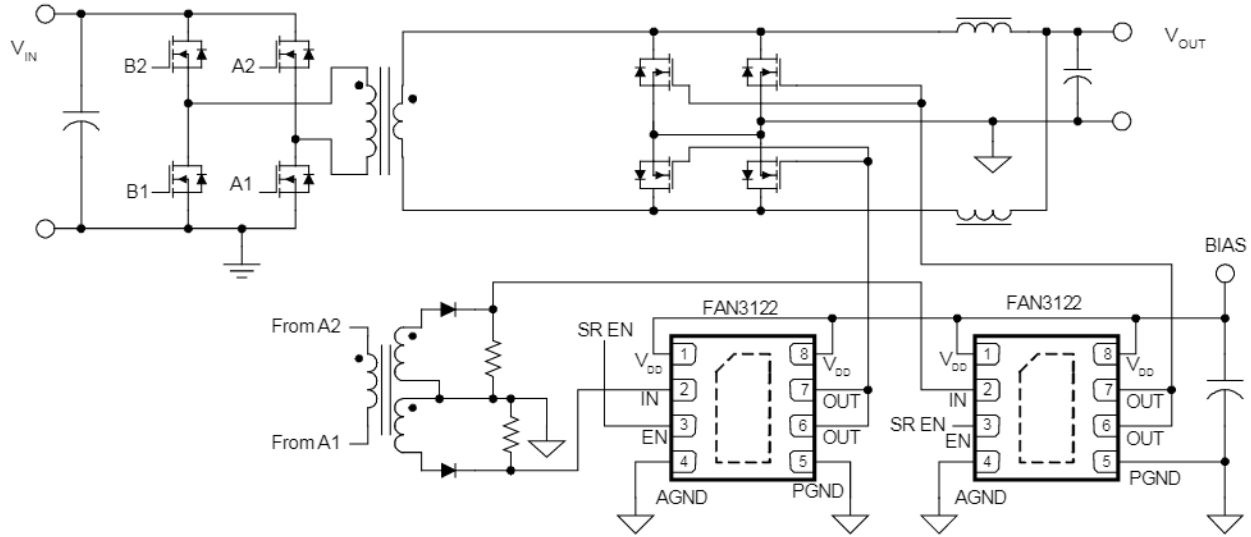


Figure 53. Full-Bridge Synchronous Rectification

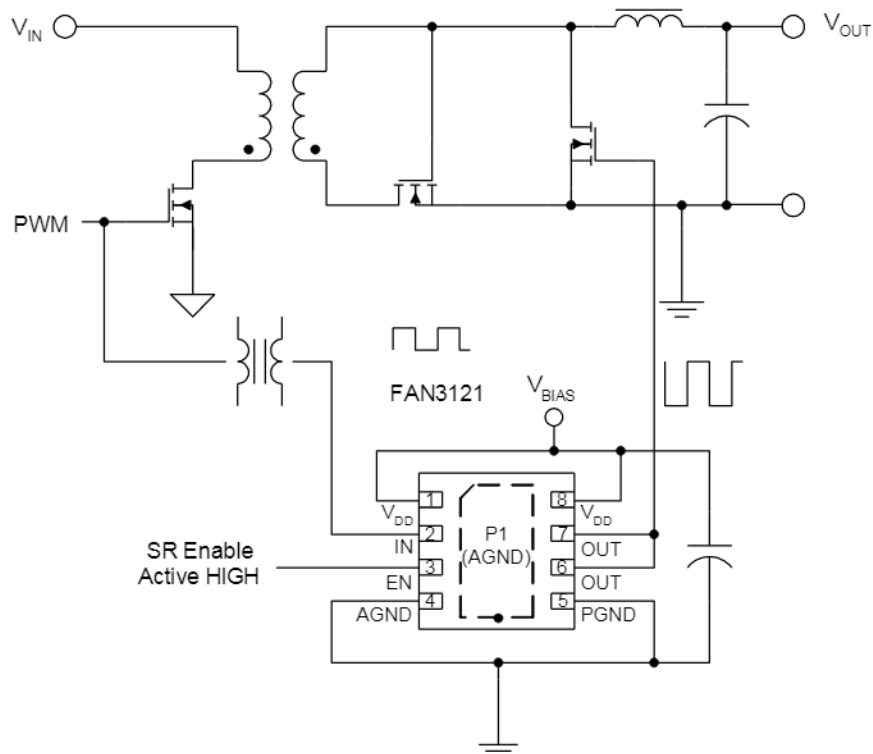


Figure 54. Hybrid Synchronous Rectification in a Forward Converter

Table 1. Related Products

Part Number	Type	Gate Drive <sup>(16)</sup> (Sink/Src)	Input Threshold	Logic	Package <sup>(18)</sup>
FAN3111C	Single 1 A	+1.1 A / -0.9 A	CMOS	Single Channel of Dual-Input/Single-Output	SOT23-5, MLP6
FAN3111E	Single 1 A	+1.1 A / -0.9 A	External <sup>(17)</sup>	Single Non-Inverting Channel with External Reference	SOT23-5, MLP6
FAN3100C	Single 2 A	+2.5 A / -1.8 A	CMOS	Single Channel of Two-Input/One-Output	SOT23-5, MLP6
FAN3100T	Single 2 A	+2.5 A / -1.8 A	TTL	Single Channel of Two-Input/One-Output	SOT23-5, MLP6
FAN3180	Single 2 A	+2.4 A / -1.6 A	TTL	Single Non-Inverting Channel + 3.3 V LDO	SOT23-5
FAN3216T	Dual 2 A	+2.4 A / -1.6 A	TTL	Dual Inverting Channels	SOIC8
FAN3217T	Dual 2 A	+2.4 A / -1.6 A	TTL	Dual Non-Inverting Channels	SOIC8
FAN3226C	Dual 2 A	+2.4 A / -1.6 A	CMOS	Dual Inverting Channels + Dual Enable	SOIC8, MLP8
FAN3226T	Dual 2 A	+2.4 A / -1.6 A	TTL	Dual Inverting Channels + Dual Enable	SOIC8, MLP8
FAN3227C	Dual 2 A	+2.4 A / -1.6 A	CMOS	Dual Non-Inverting Channels + Dual Enable	SOIC8, MLP8
FAN3227T	Dual 2 A	+2.4 A / -1.6 A	TTL	Dual Non-Inverting Channels + Dual Enable	SOIC8, MLP8
FAN3228C	Dual 2 A	+2.4 A / -1.6 A	CMOS	Dual Channels of Two-Input/One-Output	SOIC8, MLP8
FAN3228T	Dual 2A	+2.4 A / -1.6 A	TTL	Dual Channels of Two-Input/One-Output	SOIC8, MLP8
FAN3229C	Dual 2 A	+2.4 A / -1.6 A	CMOS	Dual Channels of Two-Input/One-Output	SOIC8, MLP8
FAN3229T	Dual 2 A	+2.4 A / -1.6 A	TTL	Dual Channels of Two-Input/One-Output	SOIC8, MLP8
FAN3268T	Dual 2 A	+2.4 A / -1.6 A	TTL	20 V Non-Inverting Channel (NMOS) and Inverting Channel (PMOS) + Dual Enables	SOIC8
FAN3278T	Dual 2 A	+2.4 A / -1.6 A	TTL	30 V Non-Inverting Channel (NMOS) and Inverting Channel (PMOS) + Dual Enables	SOIC8
FAN3223C	Dual 4 A	+4.3 A / -2.8 A	CMOS	Dual Inverting Channels + Dual Enable	SOIC8, MLP8
FAN3213T	Dual 4 A	+4.3 A / -2.8 A	TTL	Dual Inverting Channels	SOIC8
FAN3214T	Dual 4 A	+4.3 A / -2.8 A	TTL	Dual Non-Inverting Channels	SOIC8
FAN3223T	Dual 4 A	+4.3 A / -2.8 A	TTL	Dual Inverting Channels + Dual Enable	SOIC8, MLP8
FAN3224C	Dual 4 A	+4.3 A / -2.8 A	CMOS	Dual Non-Inverting Channels + Dual Enable	SOIC8, MLP8
FAN3224T	Dual 4 A	+4.3 A / -2.8 A	TTL	Dual Non-Inverting Channels + Dual Enable	SOIC8, MLP8
FAN3225C	Dual 4 A	+4.3 A / -2.8 A	CMOS	Dual Channels of Two-Input/One-Output	SOIC8, MLP8
FAN3225T	Dual 4 A	+4.3 A / -2.8 A	TTL	Dual Channels of Two-Input/One-Output	SOIC8, MLP8
<b>FAN3121C</b>	<b>Single 9 A</b>	<b>+9.7 A / -7.1 A</b>	<b>CMOS</b>	<b>Single Inverting Channel + Enable</b>	<b>SOIC8, MLP8</b>
<b>FAN3121T</b>	<b>Single 9 A</b>	<b>+9.7 A / -7.1 A</b>	<b>TTL</b>	<b>Single Inverting Channel + Enable</b>	<b>SOIC8, MLP8</b>
<b>FAN3122C</b>	<b>Single 9 A</b>	<b>+9.7 A / -7.1 A</b>	<b>CMOS</b>	<b>Single Non-Inverting Channel + Enable</b>	<b>SOIC8, MLP8</b>
<b>FAN3122T</b>	<b>Single 9 A</b>	<b>+9.7 A / -7.1 A</b>	<b>TTL</b>	<b>Single Non-Inverting Channel + Enable</b>	<b>SOIC8, MLP8</b>
FAN3240	Dual 12 A	> +12.0 A	TTL	Dual-Coil Relay Driver, Timing Config. 0	SOIC8
FAN3241	Dual 12 A	> +12.0 A	TTL	Dual-Coil Relay Driver, Timing Config. 1	SOIC8

**Notes:**16. Typical currents with OUT at 6 V and  $V_{DD} = 12$  V.

17. Thresholds proportional to an externally supplied reference voltage.

18. Automotive-qualified F085 versions are only offered in SOIC8 packages.

Physical Dimensions

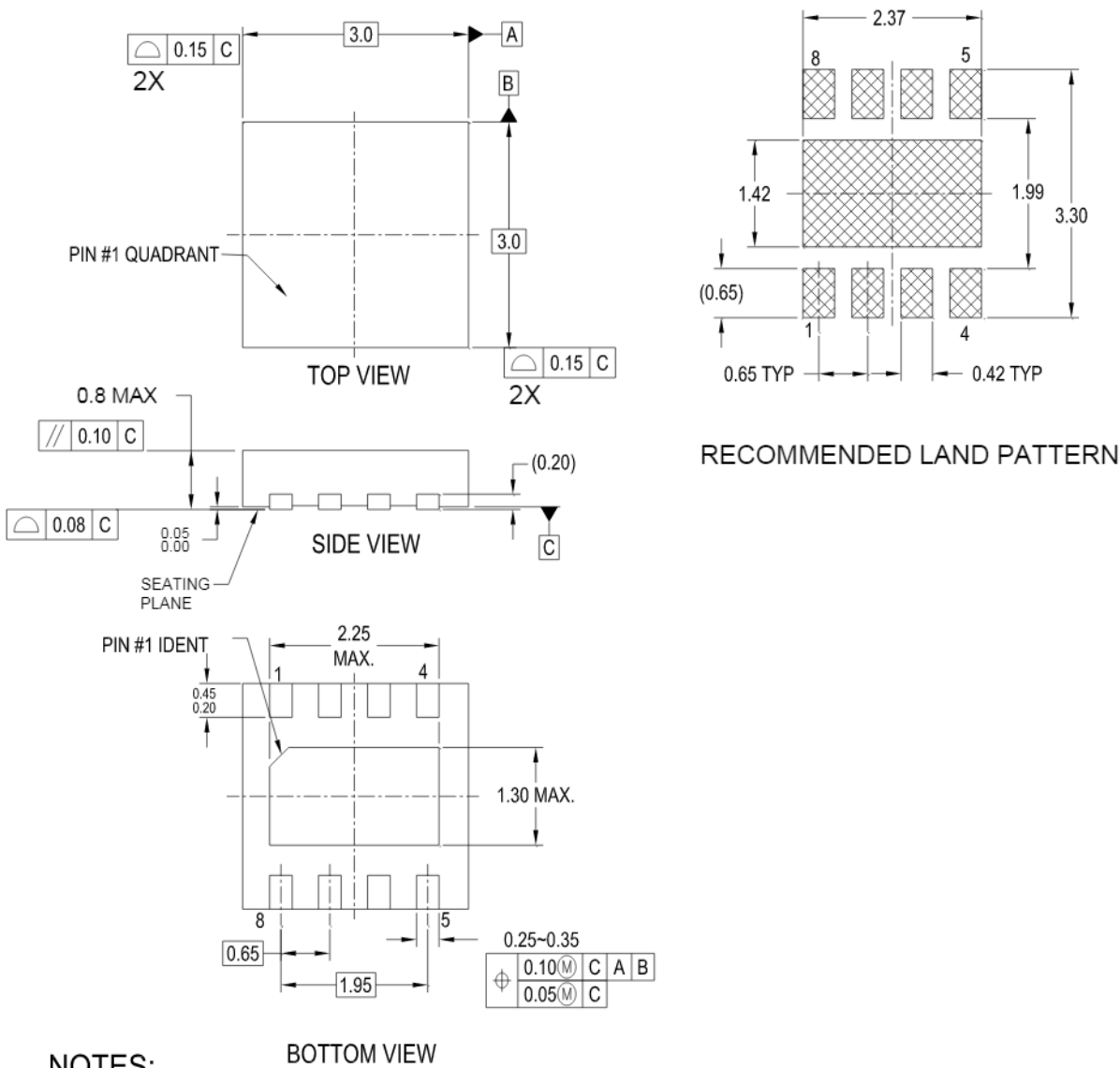


Figure 55. 3x3 mm, 8-Lead Molded Leadless Package (MLP)

Physical Dimensions (Continued)

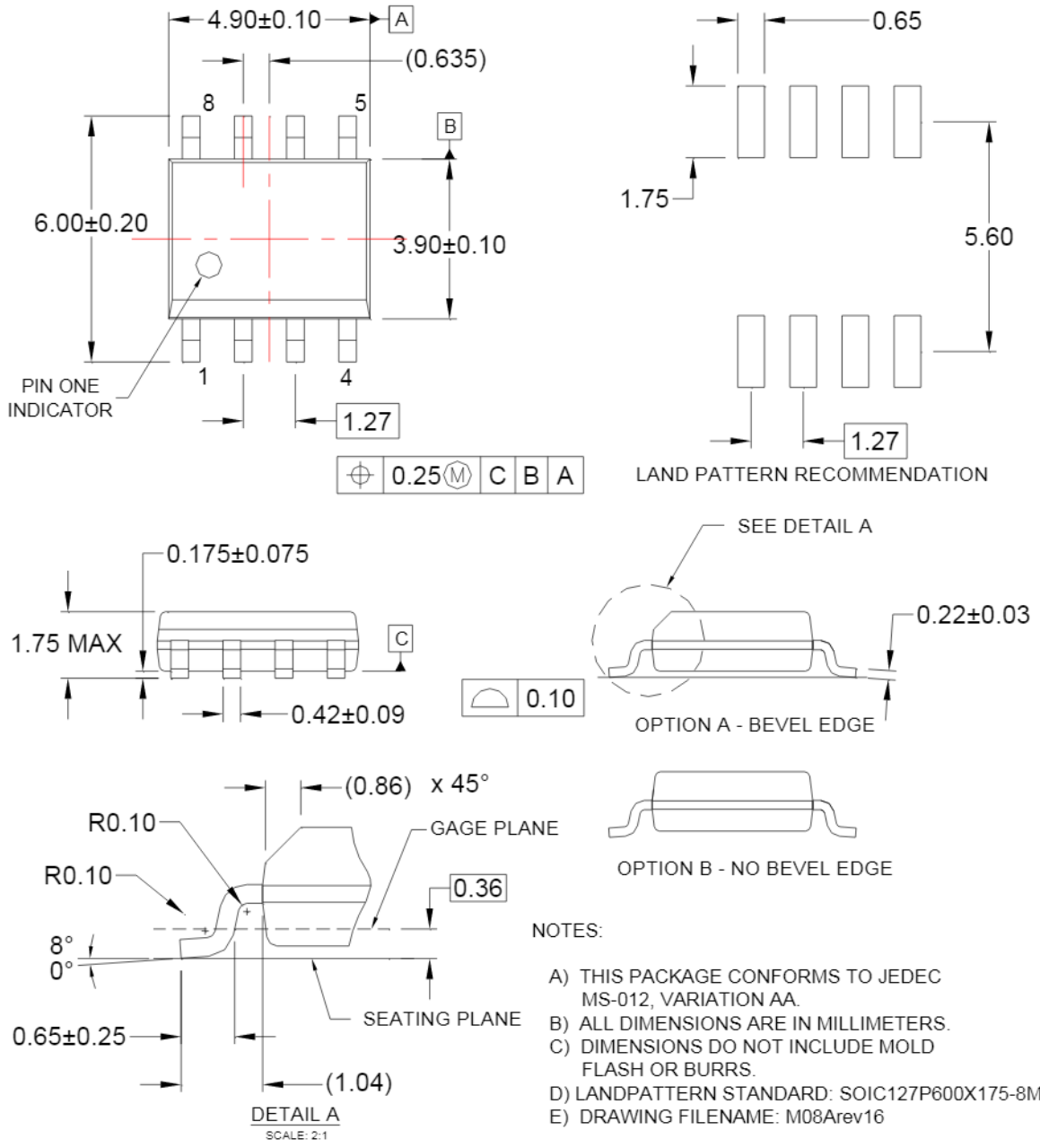


Figure 56. 8-Lead Small Outline Integrated Circuit (SOIC)

ON Semiconductor and the ON Semiconductor logo are trademarks of Semiconductor Components Industries, LLC dba ON Semiconductor or its subsidiaries in the United States and/or other countries. ON Semiconductor owns the rights to a number of patents, trademarks, copyrights, trade secrets, and other intellectual property. A listing of ON Semiconductor's product/patent coverage may be accessed at [www.onsemi.com/site/pdf/Patent-Marking.pdf](http://www.onsemi.com/site/pdf/Patent-Marking.pdf). ON Semiconductor reserves the right to make changes without further notice to any products herein. ON Semiconductor makes no warranty, representation or guarantee regarding the suitability of its products for any particular purpose, nor does ON Semiconductor assume any liability arising out of the application or use of any product or circuit, and specifically disclaims any and all liability, including without limitation special, consequential or incidental damages. Buyer is responsible for its products and applications using ON Semiconductor products, including compliance with all laws, regulations and safety requirements or standards, regardless of any support or applications information provided by ON Semiconductor. "Typical" parameters which may be provided in ON Semiconductor data sheets and/or specifications can and do vary in different applications and actual performance may vary over time. All operating parameters, including "Typicals" must be validated for each customer application by customer's technical experts. ON Semiconductor does not convey any license under its patent rights nor the rights of others. ON Semiconductor products are not designed, intended, or authorized for use as a critical component in life support systems or any FDA Class 3 medical devices or medical devices with a same or similar classification in a foreign jurisdiction or any devices intended for implantation in the human body. Should Buyer purchase or use ON Semiconductor products for any such unintended or unauthorized application, Buyer shall indemnify and hold ON Semiconductor and its officers, employees, subsidiaries, affiliates, and distributors harmless against all claims, costs, damages, and expenses, and reasonable attorney fees arising out of, directly or indirectly, any claim of personal injury or death associated with such unintended or unauthorized use, even if such claim alleges that ON Semiconductor was negligent regarding the design or manufacture of the part. ON Semiconductor is an Equal Opportunity/Affirmative Action Employer. This literature is subject to all applicable copyright laws and is not for resale in any manner.

## PUBLICATION ORDERING INFORMATION

### LITERATURE FULFILLMENT:

Literature Distribution Center for ON Semiconductor  
19521 E. 32nd Pkwy, Aurora, Colorado 80011 USA  
**Phone:** 303-675-2175 or 800-344-3860 Toll Free USA/Canada  
**Fax:** 303-675-2176 or 800-344-3867 Toll Free USA/Canada  
**Email:** [orderlit@onsemi.com](mailto:orderlit@onsemi.com)

**N. American Technical Support:** 800-282-9855 Toll Free  
USA/Canada.

**Europe, Middle East and Africa Technical Support:**  
Phone: 421 33 790 2910

**Japan Customer Focus Center**  
Phone: 81-3-5817-1050

**ON Semiconductor Website:** [www.onsemi.com](http://www.onsemi.com)

**Order Literature:** <http://www.onsemi.com/orderlit>

For additional information, please contact your local  
Sales Representative