

# MBR2045EMFS, NRVB2045EMFS

## Switch-mode Power Rectifiers

These state-of-the-art devices have the following features:

### Features

- Low Power Loss / High Efficiency
- New Package Provides Capability of Inspection and Probe After Board Mounting
- Guardring for Stress Protection
- Low Forward Voltage Drop
- 150°C Operating Junction Temperature
- Wettable Flacks Option Available
- NRV Prefix for Automotive and Other Applications Requiring Unique Site and Control Change Requirements; AEC-Q101 Qualified and PPAP Capable
- These are Pb-Free and Halide-Free Devices

### Mechanical Characteristics:

- Case: Epoxy, Molded
- Epoxy Meets Flammability Rating UL 94-0 @ 0.125 in.
- Lead Finish: 100% Matte Sn (Tin)
- Lead and Mounting Surface Temperature for Soldering Purposes: 260°C Max. for 10 Seconds
- Device Meets MSL 1 Requirements

### Applications

- Excellent Alternative to DPAK in Space-Constrained Automotive Applications
- Output Rectification in Compact Portable Consumer Applications
- Freewheeling Diode used with Inductive Loads



**ON Semiconductor®**

<http://onsemi.com>

## SCHOTTKY BARRIER RECTIFIERS 20 AMPERES 45 VOLTS

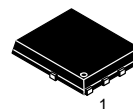
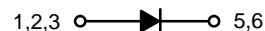

SO-8 FLAT LEAD  
CASE 488AA  
STYLE 2

### MARKING DIAGRAM

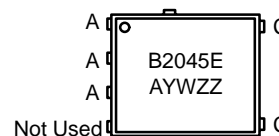

B2045E = Specific Device Code  
A = Assembly Location  
Y = Year  
W = Work Week  
ZZ = Lot Traceability

### ORDERING INFORMATION

Device	Package	Shipping†
MBR2045EMFST1G	SO-8 FL (Pb-Free)	1500 / Tape & Reel
MBR2045EMFST3G	SO-8 FL (Pb-Free)	5000 / Tape & Reel
NRVB2045EMFST1G	SO-8 FL (Pb-Free)	1500 / Tape & Reel
NRVB2045EMFST3G	SO-8 FL (Pb-Free)	5000 / Tape & Reel

†For information on tape and reel specifications, including part orientation and tape sizes, please refer to our Tape and Reel Packaging Specification Brochure, BRD8011/D.

# MBR2045EMFS, NRVB2045EMFS

## MAXIMUM RATINGS

Rating	Symbol	Value	Unit
Peak Repetitive Reverse Voltage Working Peak Reverse Voltage DC Blocking Voltage	$V_{RRM}$ $V_{RWM}$ $V_R$	45	V
Average Rectified Forward Current (Rated $V_R$ , $T_C = 130^\circ\text{C}$ )	$I_{F(AV)}$	20	A
Peak Repetitive Forward Current, (Rated $V_R$ , Square Wave, 20 kHz, $T_C = 120^\circ\text{C}$ )	$I_{FRM}$	40	A
Non-Repetitive Peak Surge Current (Surge Applied at Rated Load Conditions Halfwave, Single Phase, 60 Hz)	$I_{FSM}$	400	A
Storage Temperature Range	$T_{stg}$	-65 to +175	$^\circ\text{C}$
Operating Junction Temperature	$T_J$	-55 to +150	$^\circ\text{C}$
Unclamped Inductive Switching Energy (10 mH Inductor, Non-repetitive)	$E_{AS}$	150	mJ
ESD Rating (Human Body Model)		3B	
ESD Rating (Machine Model)		M4	

Stresses exceeding those listed in the Maximum Ratings table may damage the device. If any of these limits are exceeded, device functionality should not be assumed, damage may occur and reliability may be affected.

NOTE: The heat generated must be less than the thermal conductivity from Junction-to-Ambient:  $dPD/dT_J < 1/RJA$

## THERMAL CHARACTERISTICS

Characteristic	Symbol	Typ	Max	Unit
Thermal Resistance, Junction-to-Case, Steady State (Assumes 600 mm <sup>2</sup> 1 oz. copper bond pad, on a FR4 board)	$R_{\theta JC}$	-	1.6	$^\circ\text{C}/\text{W}$

## ELECTRICAL CHARACTERISTICS

Instantaneous Forward Voltage (Note 1) ( $i_F = 10\text{ A}$ , $T_J = 125^\circ\text{C}$ ) ( $i_F = 10\text{ A}$ , $T_J = 25^\circ\text{C}$ ) ( $i_F = 20\text{ A}$ , $T_J = 125^\circ\text{C}$ ) ( $i_F = 20\text{ A}$ , $T_J = 25^\circ\text{C}$ )	$V_F$	0.35	0.47	V
		0.45	0.56	
		0.43	0.58	
		0.51	0.64	
Instantaneous Reverse Current (Note 1) (Rated dc Voltage, $T_J = 125^\circ\text{C}$ ) (Rated dc Voltage, $T_J = 25^\circ\text{C}$ )	$i_R$	48	100	mA
		0.09	0.40	

Product parametric performance is indicated in the Electrical Characteristics for the listed test conditions, unless otherwise noted. Product performance may not be indicated by the Electrical Characteristics if operated under different conditions.

1. Pulse Test: Pulse Width = 300  $\mu\text{s}$ , Duty Cycle  $\leq 2.0\%$ .

# MBR2045EMFS, NRVB2045EMFS

## TYPICAL CHARACTERISTICS

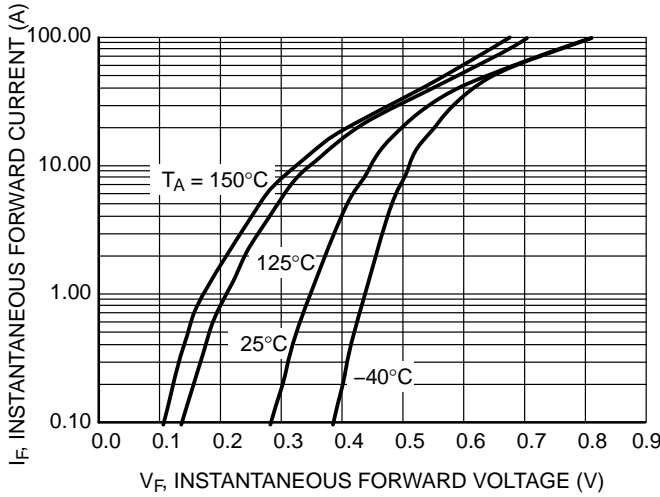

**Figure 1. Typical Instantaneous Forward Voltage**

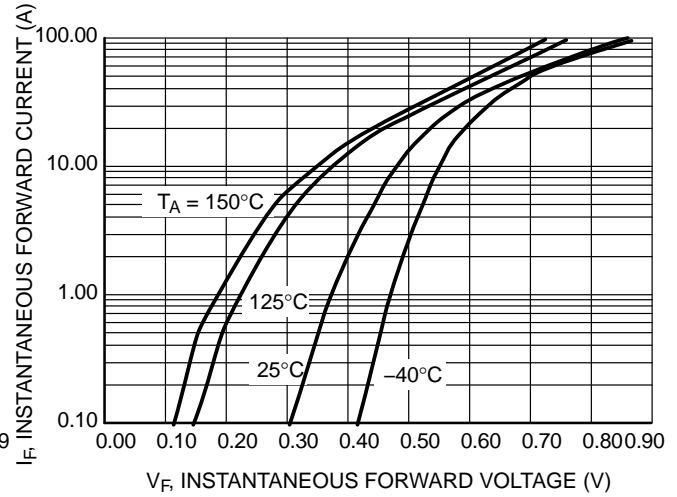

**Figure 2. Maximum Instantaneous Forward Voltage**

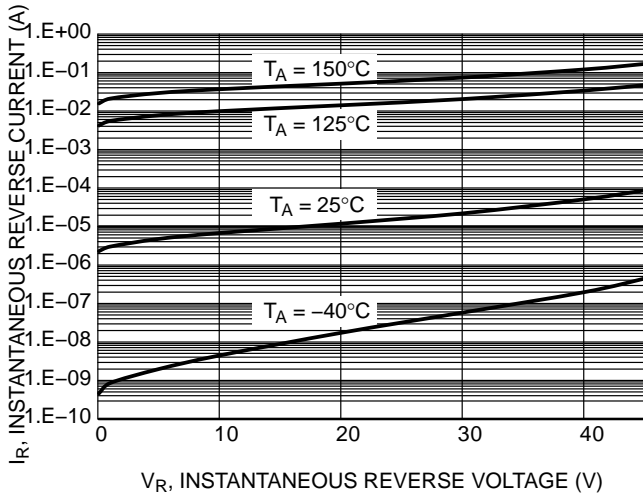

**Figure 3. Typical Reverse Characteristics**

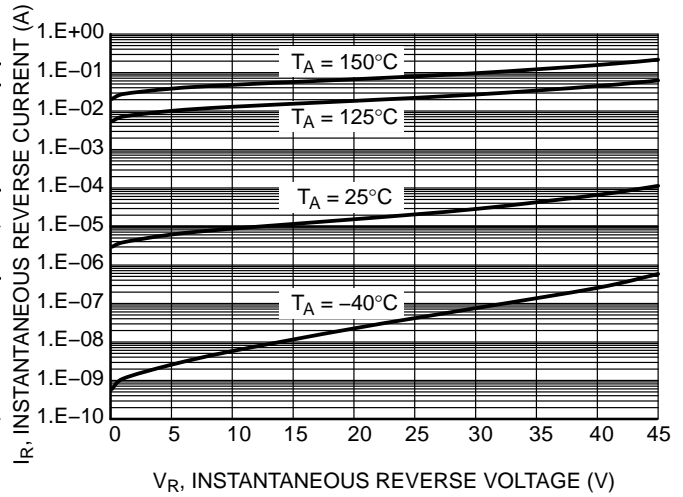

**Figure 4. Maximum Reverse Characteristics**

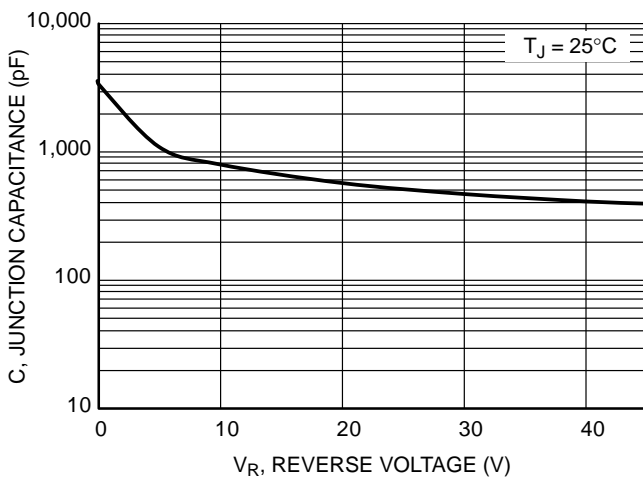

**Figure 5. Typical Junction Capacitance**

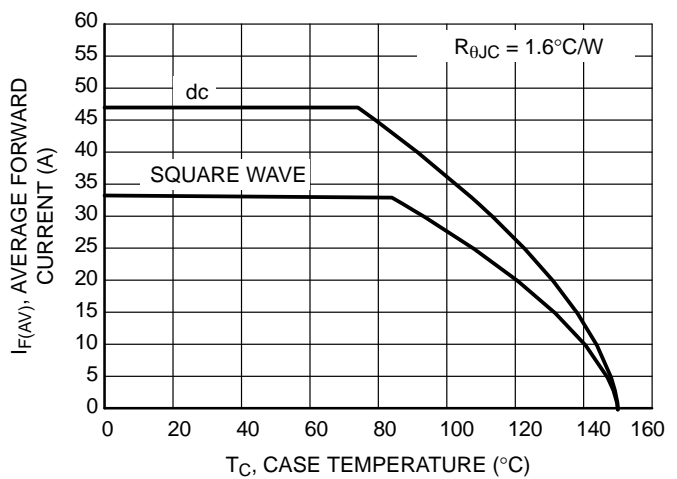

**Figure 6. Current Derating**

# MBR2045EMFS, NRVB2045EMFS

## TYPICAL CHARACTERISTICS

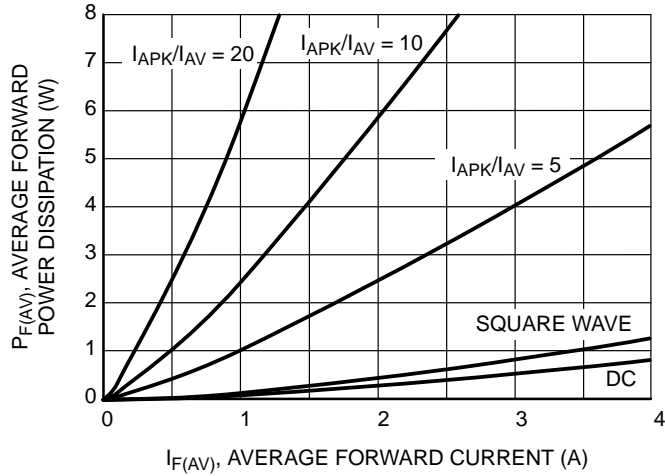

Figure 7. Forward Power Dissipation

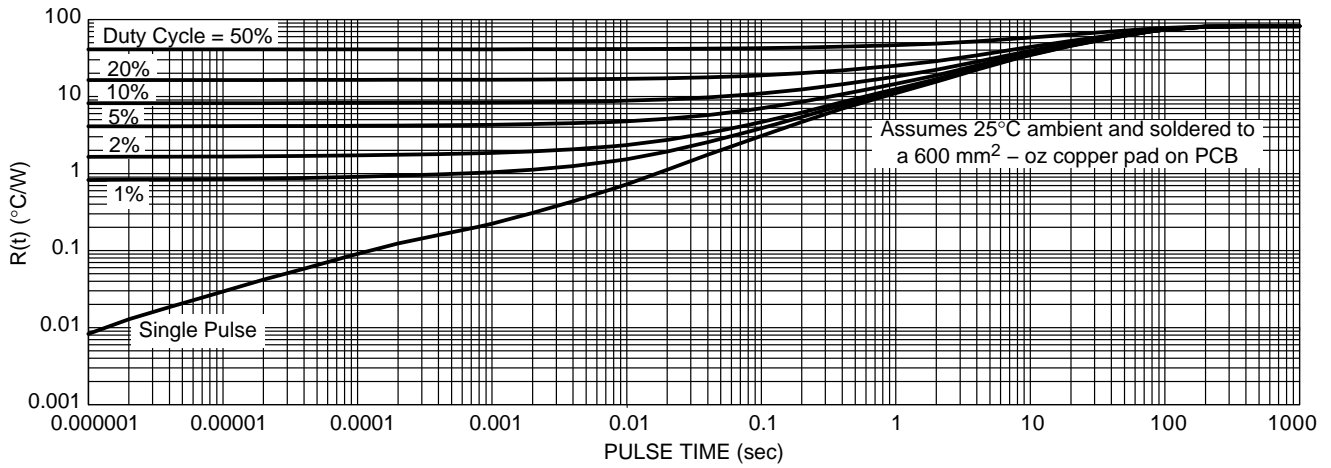
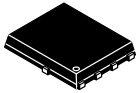

Figure 8. Thermal Response

# MECHANICAL CASE OUTLINE

## PACKAGE DIMENSIONS

ON Semiconductor®



1  
SCALE 2:1

DFN5 5x6, 1.27P  
(SO-8FL)  
CASE 488AA  
ISSUE N

DATE 25 JUN 2018

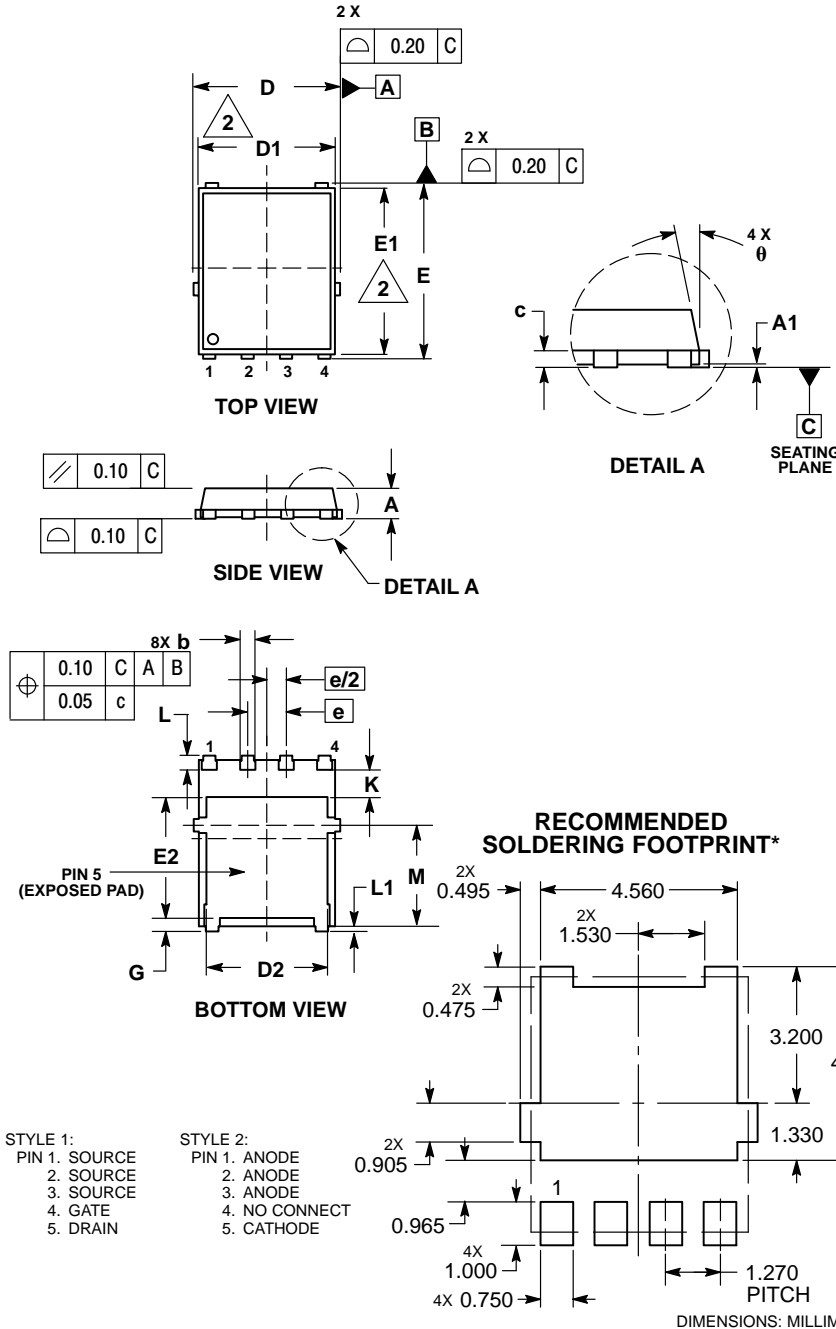

NOTES:

1. DIMENSIONING AND TOLERANCING PER ASME Y14.5M, 1994.
2. CONTROLLING DIMENSION: MILLIMETER.
3. DIMENSION D1 AND E1 DO NOT INCLUDE MOLD FLASH PROTRUSIONS OR GATE BURRS.

MILLIMETERS			
DIM	MIN	NOM	MAX
A	0.90	1.00	1.10
A1	0.00	---	0.05
b	0.33	0.41	0.51
c	0.23	0.28	0.33
D	5.00	5.15	5.30
D1	4.70	4.90	5.10
D2	3.80	4.00	4.20
E	6.00	6.15	6.30
E1	5.70	5.90	6.10
E2	3.45	3.65	3.85
e	1.27 BSC		
G	0.51	0.575	0.71
K	1.20	1.35	1.50
L	0.51	0.575	0.71
L1	0.125 REF		
M	3.00	3.40	3.80
θ	0°	---	12°

### GENERIC MARKING DIAGRAM\*

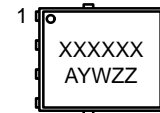

- XXXXXX = Specific Device Code
- A = Assembly Location
- Y = Year
- W = Work Week
- ZZ = Lot Traceability

\*This information is generic. Please refer to device data sheet for actual part marking. Pb-Free indicator, "G" or microdot "•", may or may not be present. Some products may not follow the Generic Marking.

### RECOMMENDED SOLDERING FOOTPRINT\*

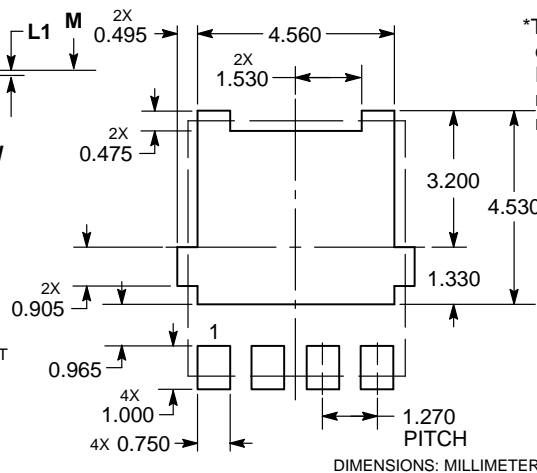

- STYLE 1:  
PIN 1. SOURCE  
2. SOURCE  
3. SOURCE  
4. GATE  
5. DRAIN
- STYLE 2:  
PIN 1. ANODE  
2. ANODE  
3. ANODE  
4. NO CONNECT  
5. CATHODE

\*For additional information on our Pb-Free strategy and soldering details, please download the ON Semiconductor Soldering and Mounting Techniques Reference Manual, SOLDERRM/D.

DOCUMENT NUMBER:	98AON14036D	Electronic versions are uncontrolled except when accessed directly from the Document Repository. Printed versions are uncontrolled except when stamped "CONTROLLED COPY" in red.
DESCRIPTION:	DFN5 5x6, 1.27P (SO-8FL)	PAGE 1 OF 1

ON Semiconductor and are trademarks of Semiconductor Components Industries, LLC dba ON Semiconductor or its subsidiaries in the United States and/or other countries. ON Semiconductor reserves the right to make changes without further notice to any products herein. ON Semiconductor makes no warranty, representation or guarantee regarding the suitability of its products for any particular purpose, nor does ON Semiconductor assume any liability arising out of the application or use of any product or circuit, and specifically disclaims any and all liability, including without limitation special, consequential or incidental damages. ON Semiconductor does not convey any license under its patent rights nor the rights of others.

ON Semiconductor and  are trademarks of Semiconductor Components Industries, LLC dba ON Semiconductor or its subsidiaries in the United States and/or other countries. ON Semiconductor owns the rights to a number of patents, trademarks, copyrights, trade secrets, and other intellectual property. A listing of ON Semiconductor's product/patent coverage may be accessed at [www.onsemi.com/site/pdf/Patent-Marking.pdf](http://www.onsemi.com/site/pdf/Patent-Marking.pdf). ON Semiconductor reserves the right to make changes without further notice to any products herein. ON Semiconductor makes no warranty, representation or guarantee regarding the suitability of its products for any particular purpose, nor does ON Semiconductor assume any liability arising out of the application or use of any product or circuit, and specifically disclaims any and all liability, including without limitation special, consequential or incidental damages. Buyer is responsible for its products and applications using ON Semiconductor products, including compliance with all laws, regulations and safety requirements or standards, regardless of any support or applications information provided by ON Semiconductor. "Typical" parameters which may be provided in ON Semiconductor data sheets and/or specifications can and do vary in different applications and actual performance may vary over time. All operating parameters, including "Typicals" must be validated for each customer application by customer's technical experts. ON Semiconductor does not convey any license under its patent rights nor the rights of others. ON Semiconductor products are not designed, intended, or authorized for use as a critical component in life support systems or any FDA Class 3 medical devices or medical devices with a same or similar classification in a foreign jurisdiction or any devices intended for implantation in the human body. Should Buyer purchase or use ON Semiconductor products for any such unintended or unauthorized application, Buyer shall indemnify and hold ON Semiconductor and its officers, employees, subsidiaries, affiliates, and distributors harmless against all claims, costs, damages, and expenses, and reasonable attorney fees arising out of, directly or indirectly, any claim of personal injury or death associated with such unintended or unauthorized use, even if such claim alleges that ON Semiconductor was negligent regarding the design or manufacture of the part. ON Semiconductor is an Equal Opportunity/Affirmative Action Employer. This literature is subject to all applicable copyright laws and is not for resale in any manner.

## PUBLICATION ORDERING INFORMATION

### LITERATURE FULFILLMENT:

Email Requests to: [orderlit@onsemi.com](mailto:orderlit@onsemi.com)

ON Semiconductor Website: [www.onsemi.com](http://www.onsemi.com)

### TECHNICAL SUPPORT

North American Technical Support:  
Voice Mail: 1 800-282-9855 Toll Free USA/Canada  
Phone: 011 421 33 790 2910

### Europe, Middle East and Africa Technical Support:

Phone: 00421 33 790 2910

For additional information, please contact your local Sales Representative