

# General Purpose Transistors

## NPN Silicon



**ON Semiconductor®**

[www.onsemi.com](http://www.onsemi.com)

## BC846ALT1G Series

### Features

- Moisture Sensitivity Level: 1
- ESD Rating – Human Body Model: > 4000 V  
– Machine Model: > 400 V
- S and NSV Prefix for Automotive and Other Applications Requiring Unique Site and Control Change Requirements; AEC-Q101 Qualified and PPAP Capable
- These Devices are Pb-Free, Halogen Free/BFR Free and are RoHS Compliant

### MAXIMUM RATINGS

Rating	Symbol	Value	Unit
Collector-Emitter Voltage BC846 BC847, BC850 BC848, BC849	$V_{CEO}$	65 45 30	Vdc
Collector-Base Voltage BC846 BC847, BC850 BC848, BC849	$V_{CBO}$	80 50 30	Vdc
Emitter-Base Voltage BC846 BC847, BC850 BC848, BC849	$V_{EBO}$	6.0 6.0 5.0	Vdc
Collector Current – Continuous	$I_C$	100	mAdc

Stresses exceeding those listed in the Maximum Ratings table may damage the device. If any of these limits are exceeded, device functionality should not be assumed, damage may occur and reliability may be affected.

### THERMAL CHARACTERISTICS

Characteristic	Symbol	Max	Unit
Total Device Dissipation FR-5 Board, (Note 1) $T_A = 25^\circ\text{C}$ Derate above $25^\circ\text{C}$	$P_D$	225	mW
Thermal Resistance, Junction-to-Ambient (Note 1)	$R_{\theta JA}$	556	$^\circ\text{C}/\text{W}$
Total Device Dissipation Alumina Substrate (Note 2) $T_A = 25^\circ\text{C}$ Derate above $25^\circ\text{C}$	$P_D$	300	mW
Thermal Resistance, Junction-to-Ambient (Note 2)	$R_{\theta JA}$	417	$^\circ\text{C}/\text{W}$
Junction and Storage Temperature Range	$T_J, T_{stg}$	-55 to +150	$^\circ\text{C}$

- FR-5 =  $1.0 \times 0.75 \times 0.062$  in.
- Alumina =  $0.4 \times 0.3 \times 0.024$  in 99.5% alumina.

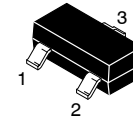
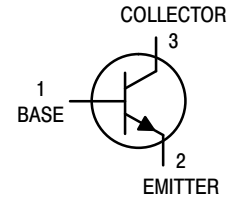

**SOT-23  
CASE 318  
STYLE 6**

### MARKING DIAGRAM

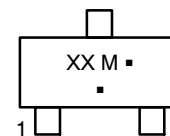

XX = Device Code  
M = Date Code\*  
▪ = Pb-Free Package

(Note: Microdot may be in either location)

\*Date Code orientation and/or overbar may vary depending upon manufacturing location.

### ORDERING INFORMATION

See detailed ordering and shipping information in the package dimensions section on page 12 of this data sheet.

## BC846ALT1G Series

### ELECTRICAL CHARACTERISTICS ( $T_A = 25^\circ\text{C}$ unless otherwise noted)

Characteristic	Symbol	Min	Typ	Max	Unit	
<b>OFF CHARACTERISTICS</b>						
Collector – Emitter Breakdown Voltage ( $I_C = 10\text{ mA}$ )	BC846A, B, C BC847A, B, C, BC850B, C BC848A, B, C, BC849B, C	$V_{(BR)CEO}$	65 45 30	– – –	– – –	V
Collector – Emitter Breakdown Voltage ( $I_C = 10\ \mu\text{A}$ , $V_{EB} = 0$ )	BC846A, B, C BC847A, B, C, BC850B, C BC848A, B, C, BC849B, C	$V_{(BR)CES}$	80 50 30	– – –	– – –	V
Collector – Base Breakdown Voltage ( $I_C = 10\ \mu\text{A}$ )	BC846A, B, C BC847A, B, C, BC850B, C BC848A, B, C, BC849B, C	$V_{(BR)CBO}$	80 50 30	– – –	– – –	V
Emitter – Base Breakdown Voltage ( $I_E = 1.0\ \mu\text{A}$ )	BC846A, B, C BC847A, B, C, BC850B, C BC848A, B, C, BC849B, C	$V_{(BR)EBO}$	6.0 6.0 5.0	– – –	– – –	V
Collector Cutoff Current ( $V_{CB} = 30\text{ V}$ ) ( $V_{CB} = 30\text{ V}$ , $T_A = 150^\circ\text{C}$ )		$I_{CBO}$	– –	– –	15 5.0	nA $\mu\text{A}$
<b>ON CHARACTERISTICS</b>						
DC Current Gain ( $I_C = 10\ \mu\text{A}$ , $V_{CE} = 5.0\text{ V}$ )	BC846A, BC847A, BC848A BC846B, BC847B, BC848B BC846C, BC847C, BC848C	$h_{FE}$	– – –	90 150 270	– – –	–
( $I_C = 2.0\text{ mA}$ , $V_{CE} = 5.0\text{ V}$ )	BC846A, BC847A, BC848A BC846B, BC847B, BC848B, BC849B, BC850B BC846C, BC847C, BC848C, BC849C, BC850C		110 200 420	180 290 520	220 450 800	
Collector – Emitter Saturation Voltage ( $I_C = 10\text{ mA}$ , $I_B = 0.5\text{ mA}$ ) ( $I_C = 100\text{ mA}$ , $I_B = 5.0\text{ mA}$ )		$V_{CE(sat)}$	– –	– –	0.25 0.6	V
Base – Emitter Saturation Voltage ( $I_C = 10\text{ mA}$ , $I_B = 0.5\text{ mA}$ ) ( $I_C = 100\text{ mA}$ , $I_B = 5.0\text{ mA}$ )		$V_{BE(sat)}$	– –	0.7 0.9	– –	V
Base – Emitter Voltage ( $I_C = 2.0\text{ mA}$ , $V_{CE} = 5.0\text{ V}$ ) ( $I_C = 10\text{ mA}$ , $V_{CE} = 5.0\text{ V}$ )		$V_{BE(on)}$	580 –	660 –	700 770	mV
<b>SMALL – SIGNAL CHARACTERISTICS</b>						
Current – Gain – Bandwidth Product ( $I_C = 10\text{ mA}$ , $V_{CE} = 5.0\text{ Vdc}$ , $f = 100\text{ MHz}$ )		$f_T$	100	–	–	MHz
Output Capacitance ( $V_{CB} = 10\text{ V}$ , $f = 1.0\text{ MHz}$ )		$C_{obo}$	–	–	4.5	pF
Noise Figure ( $I_C = 0.2\text{ mA}$ , $V_{CE} = 5.0\text{ Vdc}$ , $R_S = 2.0\text{ k}\Omega$ , $f = 1.0\text{ kHz}$ , $BW = 200\text{ Hz}$ )	BC846A,B,C, BC847A,B,C, BC848A,B,C BC849B,C, BC850B,C	NF	– –	– –	10 4.0	dB

Product parametric performance is indicated in the Electrical Characteristics for the listed test conditions, unless otherwise noted. Product performance may not be indicated by the Electrical Characteristics if operated under different conditions.

# BC846ALT1G Series

BC846A, BC847A, BC848A, SBC846A

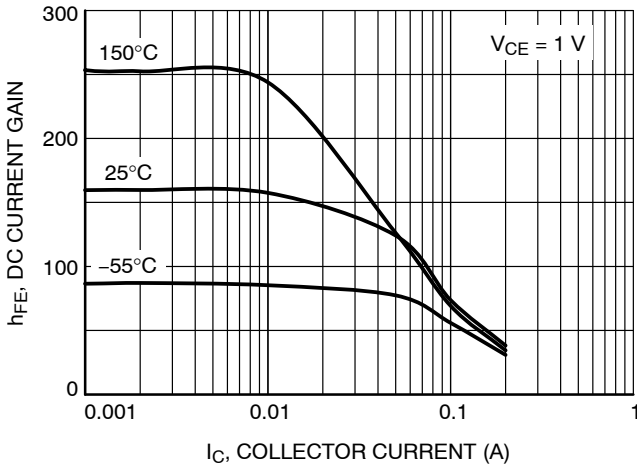

Figure 1. DC Current Gain vs. Collector Current

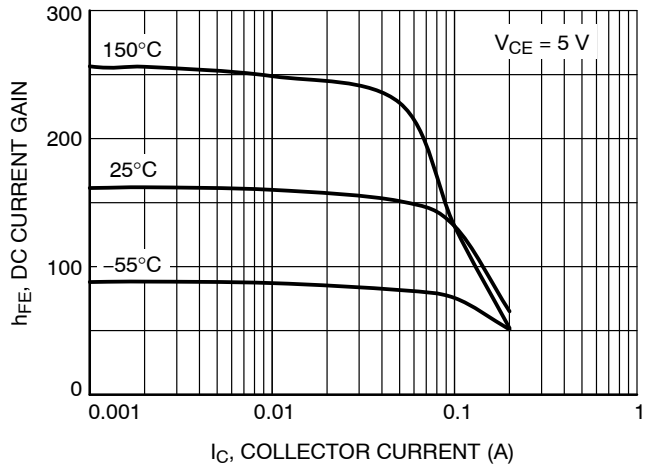

Figure 2. DC Current Gain vs. Collector Current

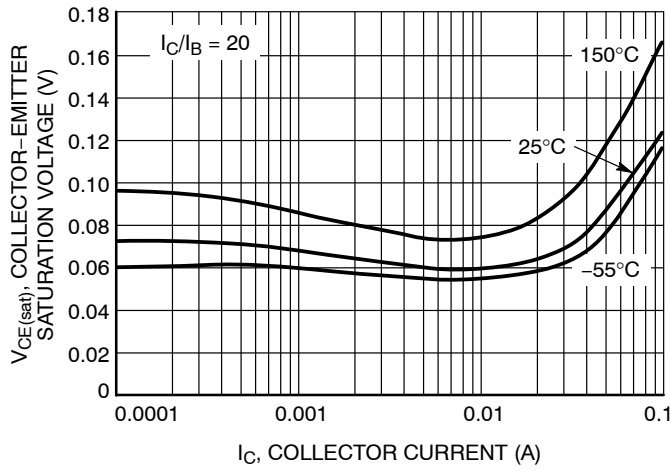

Figure 3. Collector Emitter Saturation Voltage vs. Collector Current

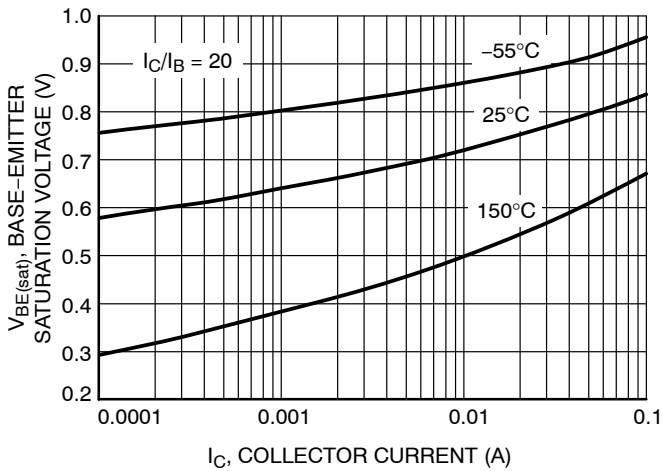

Figure 4. Base Emitter Saturation Voltage vs. Collector Current

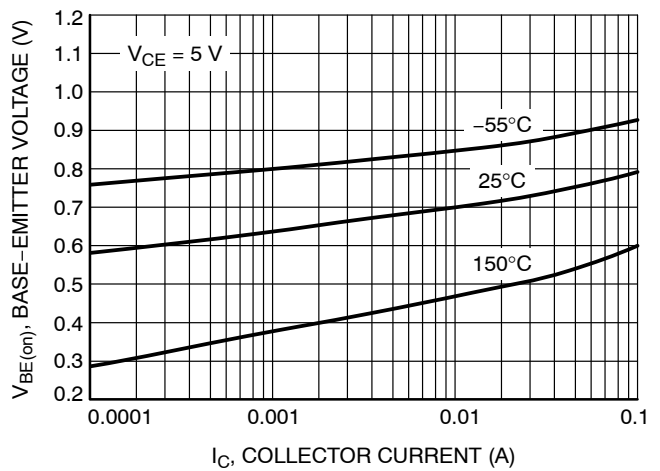

Figure 5. Base Emitter Voltage vs. Collector Current

# BC846ALT1G Series

BC846A, BC847A, BC848A, SBC846A

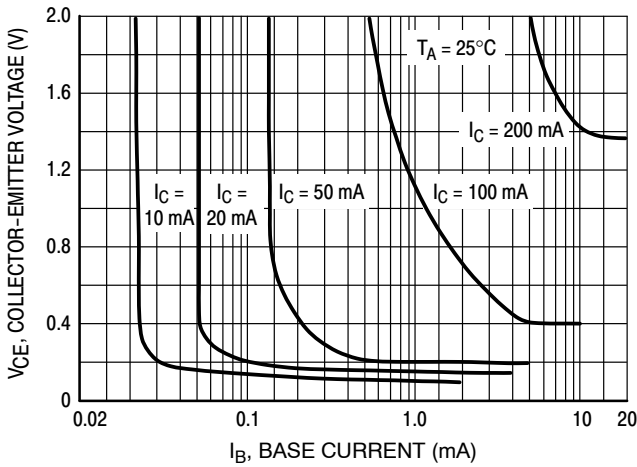

Figure 6. Collector Saturation Region



Figure 7. Base-Emitter Temperature Coefficient

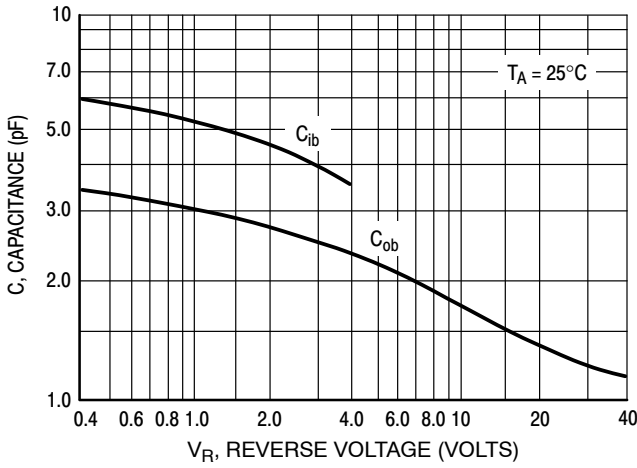

Figure 8. Capacitances

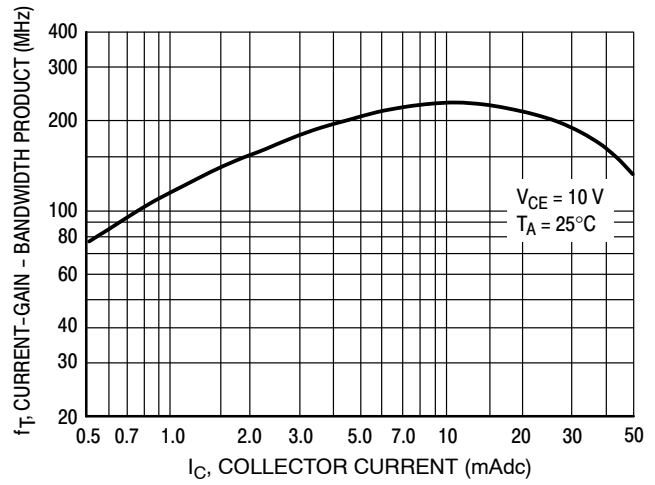
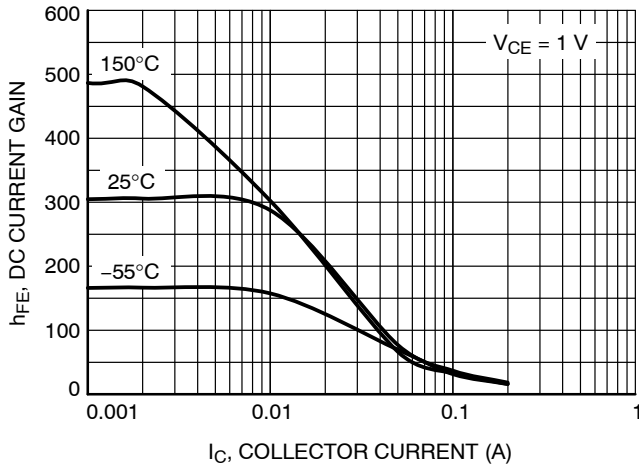

Figure 9. Current-Gain - Bandwidth Product

# BC846ALT1G Series

## BC846B, SBC846B



**Figure 10. DC Current Gain vs. Collector Current**

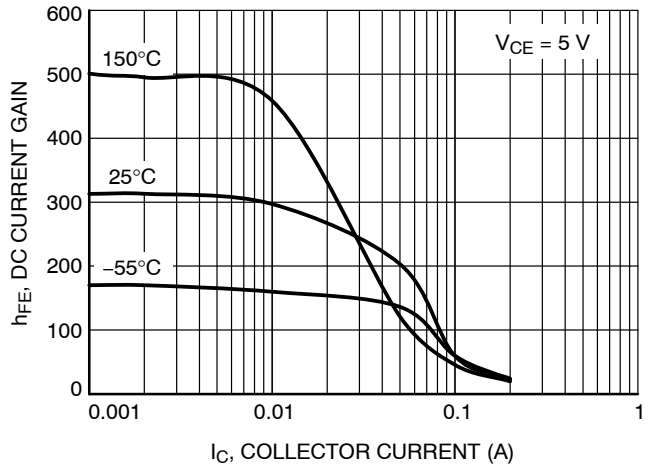

**Figure 11. DC Current Gain vs. Collector Current**

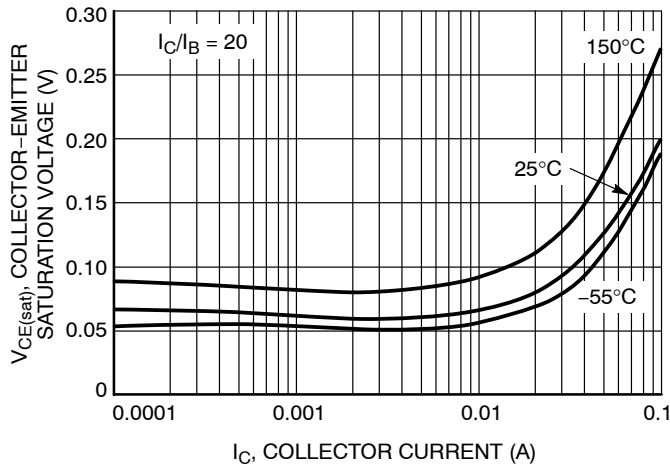

**Figure 12. Collector Emitter Saturation Voltage vs. Collector Current**

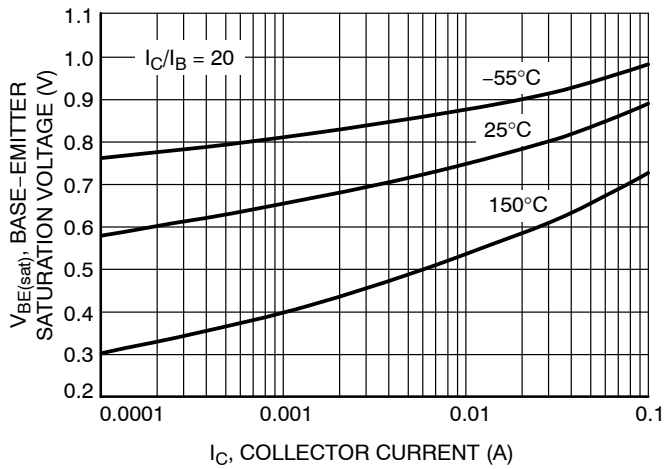

**Figure 13. Base Emitter Saturation Voltage vs. Collector Current**

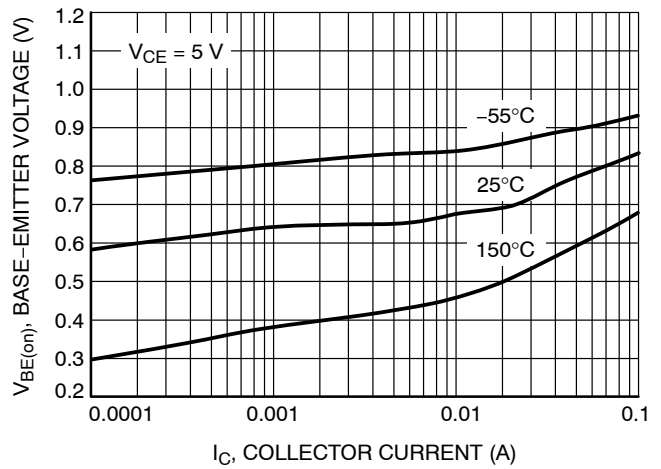

**Figure 14. Base Emitter Voltage vs. Collector Current**

# BC846ALT1G Series

## BC846B, SBC846B

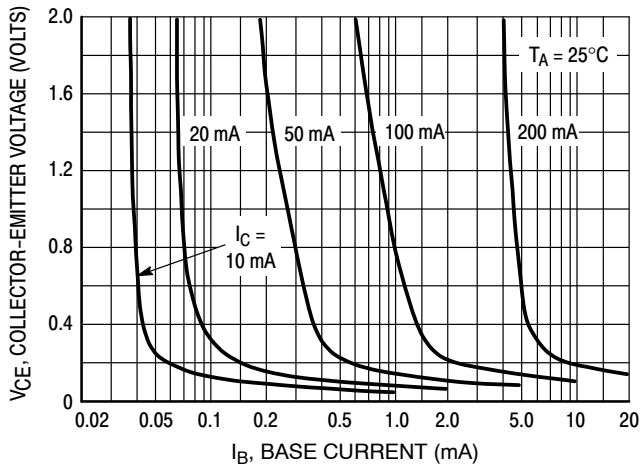

Figure 15. Collector Saturation Region

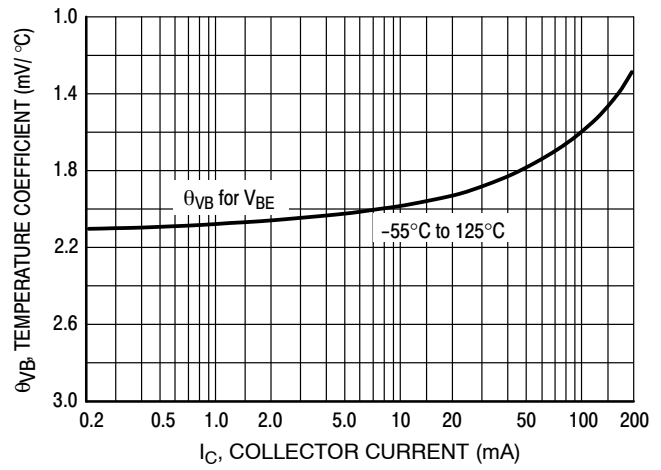

Figure 16. Base-Emitter Temperature Coefficient

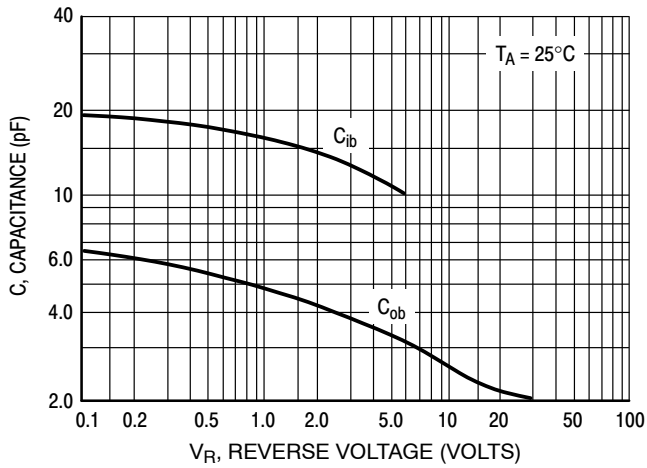

Figure 17. Capacitance

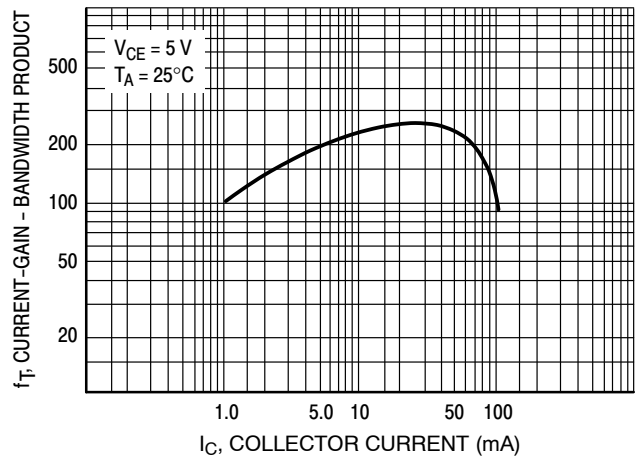

Figure 18. Current-Gain - Bandwidth Product

# BC846ALT1G Series

BC847B, BC848B, BC849B, BC850B, SBC847B, SBC848B

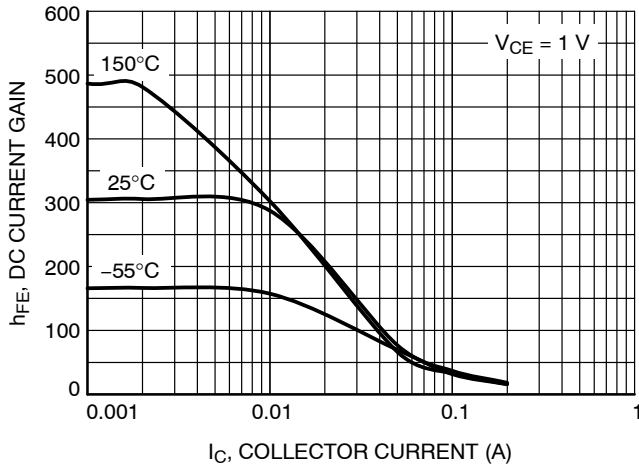

Figure 19. DC Current Gain vs. Collector Current

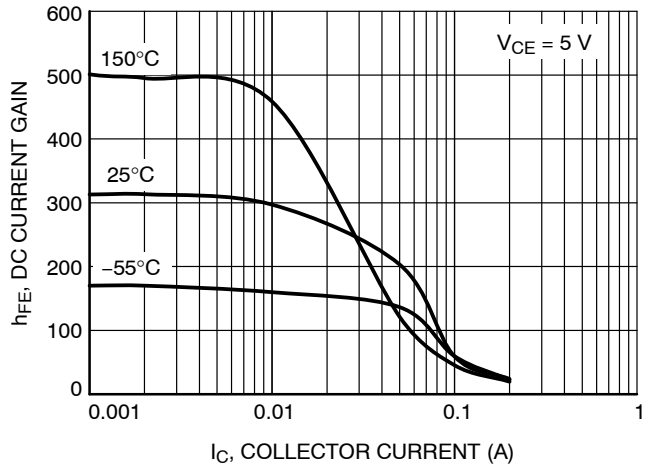

Figure 20. DC Current Gain vs. Collector Current

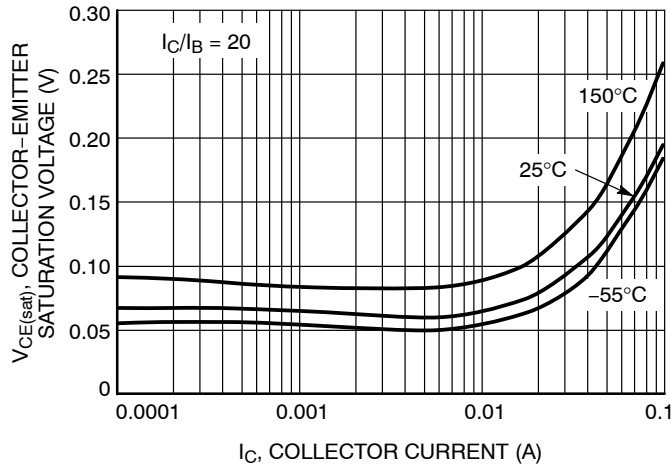

Figure 21. Collector-Emitter Saturation Voltage vs. Collector Current



Figure 22. Base-Emitter Saturation Voltage vs. Collector Current



Figure 23. Base-Emitter Voltage vs. Collector Current

# BC846ALT1G Series

BC847B, BC848B, BC849B, BC850B, SBC846B, SBC847B, SBC848B

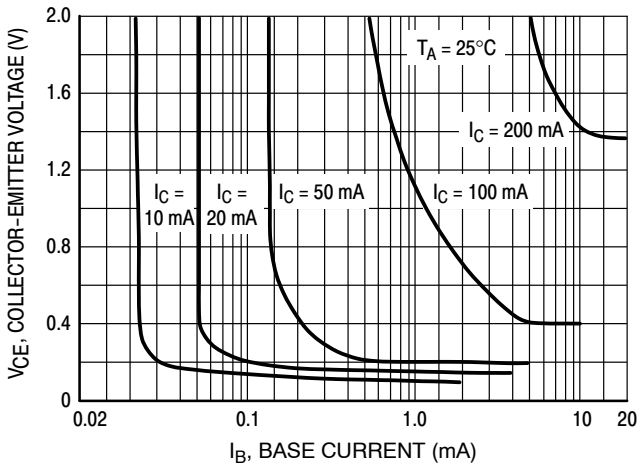

Figure 24. Collector Saturation Region



Figure 25. Base-Emitter Temperature Coefficient



Figure 26. Capacitances

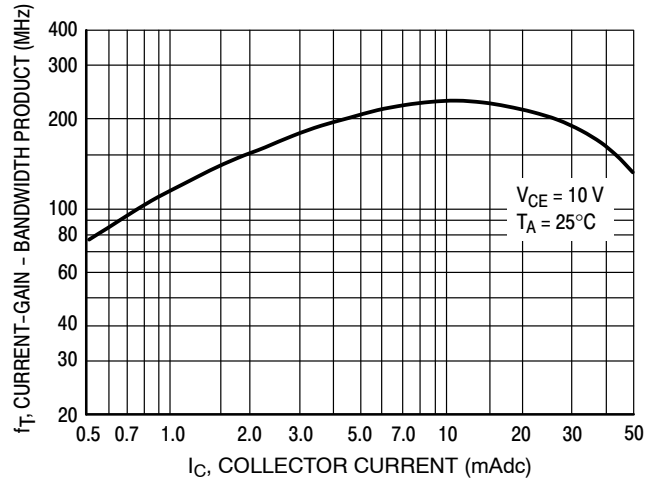

Figure 27. Current-Gain - Bandwidth Product



# BC846ALT1G Series

BC846C, BC847C, BC848C, BC849C, BC850C, SBC847C



Figure 28. DC Current Gain vs. Collector Current

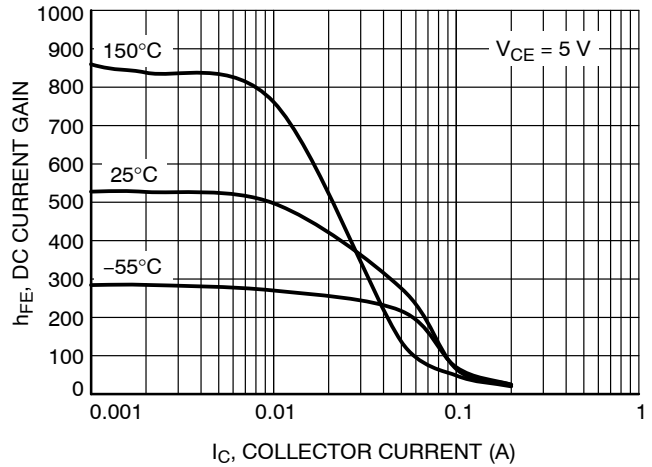

Figure 29. DC Current Gain vs. Collector Current

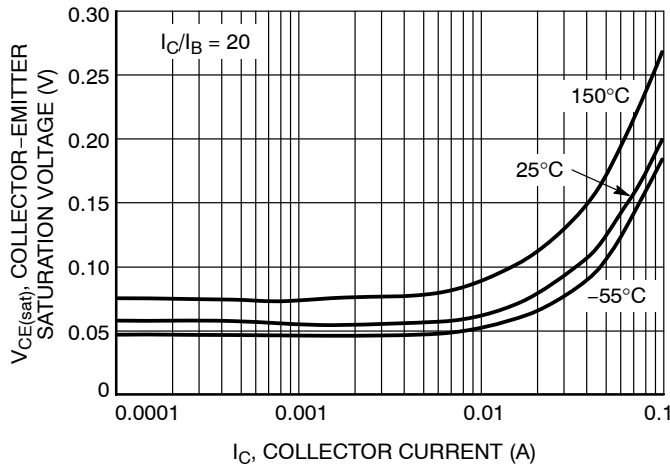

Figure 30. Collector Emitter Saturation Voltage vs. Collector Current



Figure 31. Base Emitter Saturation Voltage vs. Collector Current



Figure 32. Base Emitter Voltage vs. Collector Current

# BC846ALT1G Series

BC846C, BC847C, BC848C, BC849C, BC850C, SBC847C

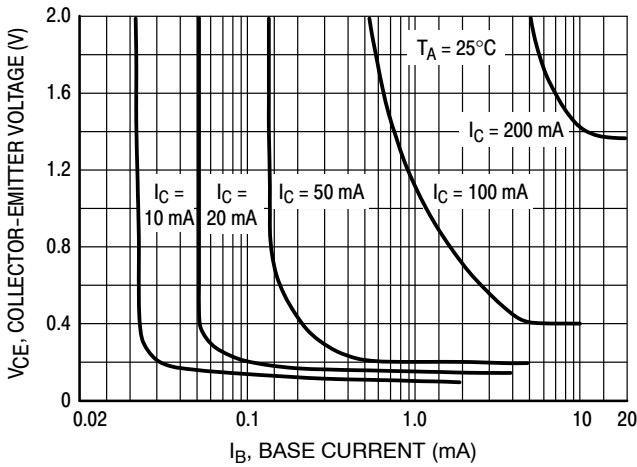

Figure 33. Collector Saturation Region



Figure 34. Base-Emitter Temperature Coefficient



Figure 35. Capacitances

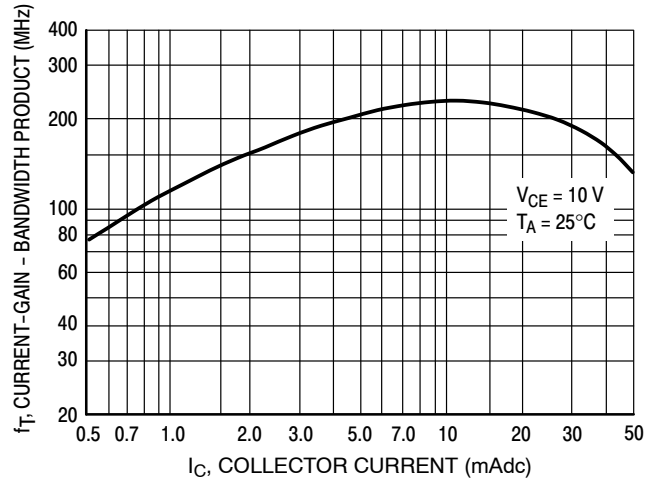
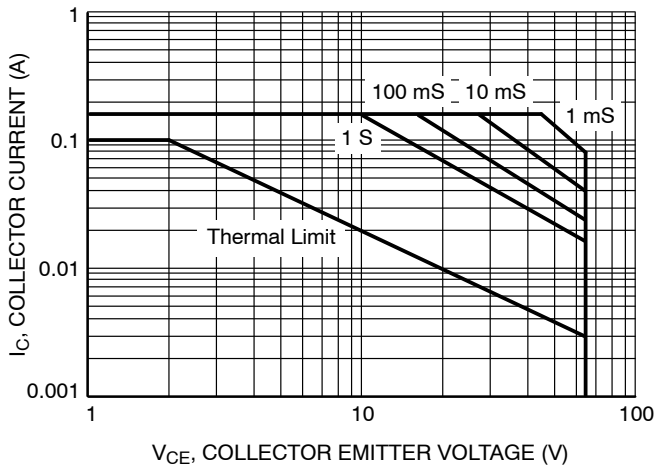
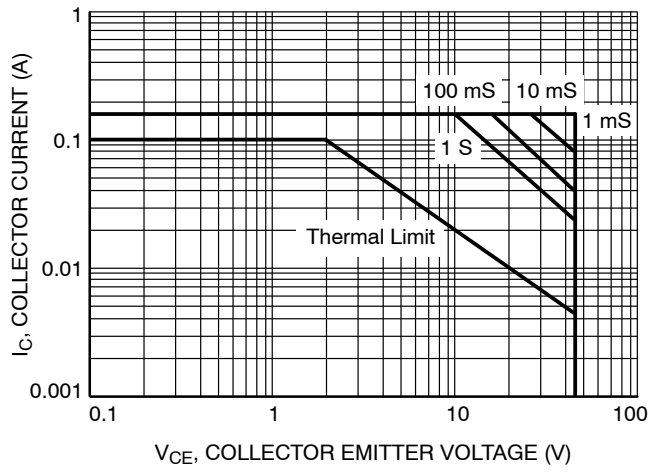

Figure 36. Current-Gain - Bandwidth Product

# BC846ALT1G Series



**Figure 37. Safe Operating Area for BC846A, BC846B, BC846C**



**Figure 38. Safe Operating Area for BC847A, BC847B, BC847C, BC850B, BC850C**

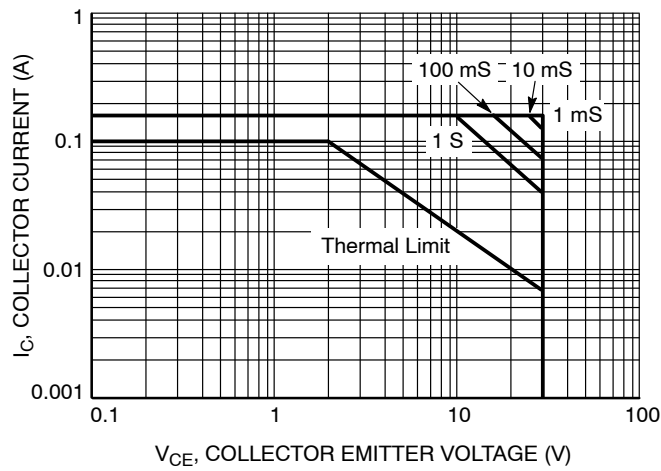

**Figure 39. Safe Operating Area for BC848A, BC848B, BC848C, BC849B, BC849C**

## BC846ALT1G Series

### ORDERING INFORMATION

Device	Marking	Package	Shipping†
BC846ALT1G	1A	SOT-23 (Pb-Free)	3,000 / Tape & Reel
SBC846ALT1G*			
BC846ALT3G			10,000 / Tape & Reel
BC846BLT1G	1B		3,000 / Tape & Reel
SBC846BLT1G*			
BC846BLT3G			10,000 / Tape & Reel
SBC846BLT3G*			
BC846CLT1G	3C		3,000 / Tape & Reel
BC847ALT1G	1E		3,000 / Tape & Reel
BC847ALT3G			10,000 / Tape & Reel
BC847BLT1G	1F		3,000 / Tape & Reel
SBC847BLT1G*			
BC847BLT3G			10,000 / Tape & Reel
NSVBC847BLT3G*			
BC847CLT1G	1G		3,000 / Tape & Reel
SBC847CLT1G*			
BC847CLT3G			10,000 / Tape & Reel
BC848ALT1G	1J		3,000 / Tape & Reel
BC848BLT1G	1K		3,000 / Tape & Reel
SBC848BLT1G*			
BC848BLT3G			10,000 / Tape & Reel
BC848CLT1G	1L		3,000 / Tape & Reel
NSVBC848CLT1G*			
BC848CLT3G			10,000 / Tape & Reel
BC849BLT1G	2B		3,000 / Tape & Reel
NSVBC849BLT1G*			
BC849BLT3G			10,000 / Tape & Reel
BC849CLT1G	2C		3,000 / Tape & Reel
BC849CLT3G			10,000 / Tape & Reel
BC850BLT1G	2F		3,000 / Tape & Reel
NSVBC850BLT1G*			
BC850CLT1G	2G		
NSVBC850CLT1G*			

†For information on tape and reel specifications, including part orientation and tape sizes, please refer to our Tape and Reel Packaging Specifications Brochure, BRD8011/D.

\*S and NSV Prefix for Automotive and Other Applications Requiring Unique Site and Control Change Requirements; AEC-Q101 Qualified and PPAP Capable.

# MECHANICAL CASE OUTLINE

## PACKAGE DIMENSIONS

ON Semiconductor®



### SOT-23 (TO-236) CASE 318-08 ISSUE AS

DATE 30 JAN 2018

SCALE 4:1



NOTES:

1. DIMENSIONING AND TOLERANCING PER ASME Y14.5M, 1994.
2. CONTROLLING DIMENSION: MILLIMETERS.
3. MAXIMUM LEAD THICKNESS INCLUDES LEAD FINISH. MINIMUM LEAD THICKNESS IS THE MINIMUM THICKNESS OF THE BASE MATERIAL.
4. DIMENSIONS D AND E DO NOT INCLUDE MOLD FLASH, PROTRUSIONS, OR GATE BURRS.

DIM	MILLIMETERS			INCHES		
	MIN	NOM	MAX	MIN	NOM	MAX
A	0.89	1.00	1.11	0.035	0.039	0.044
A1	0.01	0.06	0.10	0.000	0.002	0.004
b	0.37	0.44	0.50	0.015	0.017	0.020
c	0.08	0.14	0.20	0.003	0.006	0.008
D	2.80	2.90	3.04	0.110	0.114	0.120
E	1.20	1.30	1.40	0.047	0.051	0.055
e	1.78	1.90	2.04	0.070	0.075	0.080
L	0.30	0.43	0.55	0.012	0.017	0.022
L1	0.35	0.54	0.69	0.014	0.021	0.027
HE	2.10	2.40	2.64	0.083	0.094	0.104
T	0°	---	10°	0°	---	10°

### RECOMMENDED SOLDERING FOOTPRINT



### GENERIC MARKING DIAGRAM\*



XXX = Specific Device Code  
M = Date Code  
▪ = Pb-Free Package

\*This information is generic. Please refer to device data sheet for actual part marking. Pb-Free indicator, "G" or microdot "▪", may or may not be present.

STYLE 1 THRU 5:  
CANCELLED

STYLE 6:  
PIN 1. BASE  
2. EMITTER  
3. COLLECTOR

STYLE 7:  
PIN 1. EMITTER  
2. BASE  
3. COLLECTOR

STYLE 8:  
PIN 1. ANODE  
2. NO CONNECTION  
3. CATHODE

STYLE 9:  
PIN 1. ANODE  
2. ANODE  
3. CATHODE

STYLE 10:  
PIN 1. DRAIN  
2. SOURCE  
3. GATE

STYLE 11:  
PIN 1. ANODE  
2. CATHODE  
3. CATHODE-ANODE

STYLE 12:  
PIN 1. CATHODE  
2. CATHODE  
3. ANODE

STYLE 13:  
PIN 1. SOURCE  
2. DRAIN  
3. GATE

STYLE 14:  
PIN 1. CATHODE  
2. GATE  
3. ANODE

STYLE 15:  
PIN 1. GATE  
2. CATHODE  
3. ANODE

STYLE 16:  
PIN 1. ANODE  
2. CATHODE  
3. CATHODE

STYLE 17:  
PIN 1. NO CONNECTION  
2. ANODE  
3. CATHODE

STYLE 18:  
PIN 1. NO CONNECTION  
2. CATHODE  
3. ANODE

STYLE 19:  
PIN 1. CATHODE  
2. ANODE  
3. CATHODE-ANODE

STYLE 20:  
PIN 1. CATHODE  
2. ANODE  
3. GATE

STYLE 21:  
PIN 1. GATE  
2. SOURCE  
3. DRAIN

STYLE 22:  
PIN 1. RETURN  
2. OUTPUT  
3. INPUT

STYLE 23:  
PIN 1. ANODE  
2. ANODE  
3. CATHODE

STYLE 24:  
PIN 1. GATE  
2. DRAIN  
3. SOURCE

STYLE 25:  
PIN 1. ANODE  
2. CATHODE  
3. GATE

STYLE 26:  
PIN 1. CATHODE  
2. ANODE  
3. NO CONNECTION

STYLE 27:  
PIN 1. CATHODE  
2. CATHODE  
3. CATHODE

STYLE 28:  
PIN 1. ANODE  
2. ANODE  
3. ANODE

<b>DOCUMENT NUMBER:</b>	<b>98ASB42226B</b>	Electronic versions are uncontrolled except when accessed directly from the Document Repository. Printed versions are uncontrolled except when stamped "CONTROLLED COPY" in red.
<b>DESCRIPTION:</b>	<b>SOT-23 (TO-236)</b>	<b>PAGE 1 OF 1</b>

ON Semiconductor and ON are trademarks of Semiconductor Components Industries, LLC dba ON Semiconductor or its subsidiaries in the United States and/or other countries. ON Semiconductor reserves the right to make changes without further notice to any products herein. ON Semiconductor makes no warranty, representation or guarantee regarding the suitability of its products for any particular purpose, nor does ON Semiconductor assume any liability arising out of the application or use of any product or circuit, and specifically disclaims any and all liability, including without limitation special, consequential or incidental damages. ON Semiconductor does not convey any license under its patent rights nor the rights of others.

ON Semiconductor and  are trademarks of Semiconductor Components Industries, LLC dba ON Semiconductor or its subsidiaries in the United States and/or other countries. ON Semiconductor owns the rights to a number of patents, trademarks, copyrights, trade secrets, and other intellectual property. A listing of ON Semiconductor's product/patent coverage may be accessed at [www.onsemi.com/site/pdf/Patent-Marking.pdf](http://www.onsemi.com/site/pdf/Patent-Marking.pdf). ON Semiconductor reserves the right to make changes without further notice to any products herein. ON Semiconductor makes no warranty, representation or guarantee regarding the suitability of its products for any particular purpose, nor does ON Semiconductor assume any liability arising out of the application or use of any product or circuit, and specifically disclaims any and all liability, including without limitation special, consequential or incidental damages. Buyer is responsible for its products and applications using ON Semiconductor products, including compliance with all laws, regulations and safety requirements or standards, regardless of any support or applications information provided by ON Semiconductor. "Typical" parameters which may be provided in ON Semiconductor data sheets and/or specifications can and do vary in different applications and actual performance may vary over time. All operating parameters, including "Typicals" must be validated for each customer application by customer's technical experts. ON Semiconductor does not convey any license under its patent rights nor the rights of others. ON Semiconductor products are not designed, intended, or authorized for use as a critical component in life support systems or any FDA Class 3 medical devices or medical devices with a same or similar classification in a foreign jurisdiction or any devices intended for implantation in the human body. Should Buyer purchase or use ON Semiconductor products for any such unintended or unauthorized application, Buyer shall indemnify and hold ON Semiconductor and its officers, employees, subsidiaries, affiliates, and distributors harmless against all claims, costs, damages, and expenses, and reasonable attorney fees arising out of, directly or indirectly, any claim of personal injury or death associated with such unintended or unauthorized use, even if such claim alleges that ON Semiconductor was negligent regarding the design or manufacture of the part. ON Semiconductor is an Equal Opportunity/Affirmative Action Employer. This literature is subject to all applicable copyright laws and is not for resale in any manner.

## PUBLICATION ORDERING INFORMATION

### LITERATURE FULFILLMENT:

Email Requests to: [orderlit@onsemi.com](mailto:orderlit@onsemi.com)

ON Semiconductor Website: [www.onsemi.com](http://www.onsemi.com)

### TECHNICAL SUPPORT

North American Technical Support:  
Voice Mail: 1 800-282-9855 Toll Free USA/Canada  
Phone: 011 421 33 790 2910

Europe, Middle East and Africa Technical Support:

Phone: 00421 33 790 2910

For additional information, please contact your local Sales Representative