

**COMPLEMENTARY OUTPUT HALL EFFECT LATCH****AH276****General Description**

The AH276 is an integrated Hall sensor with output driver designed for electronic commutation of brushless DC motor applications. The device includes an on-chip Hall sensor for magnetic sensing, an amplifier that amplifies the Hall voltage, a Schmitt trigger to provide switching hysteresis for noise rejection, a temperature compensation circuit to compensate the temperature drift of Hall sensitivity and two complementary open-collector drivers for sinking large load current. It also includes an internal band-gap regulator which is used to provide bias voltage for internal circuits.

Placing the device in a variable magnetic field, if the magnetic flux density is larger than threshold  $B_{OP}$ , the pin DO will be turned low (on) and pin DOB will be turned high (off). This output state is held until the magnetic flux density reverses and falls below  $B_{RP}$ , then causes DO to be turned high (off) and DOB turned low (on).

AH276 is available in TO-94 (SIP-4L) package.

**Features**

- On-Chip Hall Sensor
- 3.5V to 16V Supply Voltage
- 350mA (avg) Output Sink Current
- Reversed Supply Voltage Protection
- Build in Over Temperature Protection Function
- -20°C to 85°C Operating Temperature
- Low Profile TO-94 (SIP-4L) Package
- ESD Rating: 300V (Machine Model)

**Applications**

- Dual-Coil Brushless DC Motor
- Dual-Coil Brushless DC Fan
- Revolution Counting
- Speed Measurement

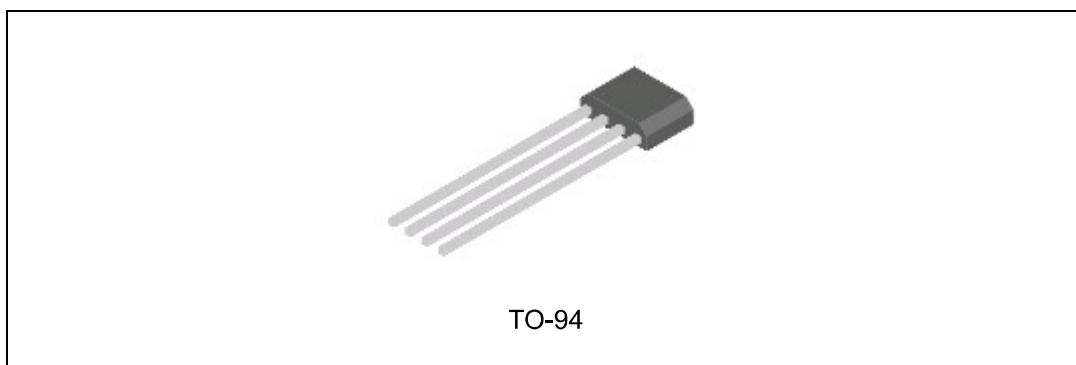

Figure 1. Package Type of AH276

**COMPLEMENTARY OUTPUT HALL EFFECT LATCH**

**AH276**

**Pin Configuration**

Z4 Package  
(TO-94)

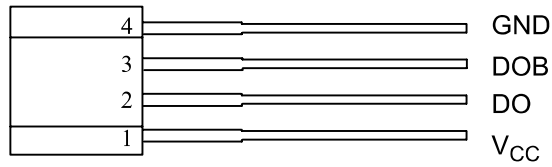

Figure 2. Pin Configuration of AH276 (Front View)

**Pin Description**

Pin Number	Pin Name	Function
1	V <sub>CC</sub>	Supply voltage
2	DO	Output 1
3	DOB	Output 2
4	GND	Ground

**COMPLEMENTARY OUTPUT HALL EFFECT LATCH**

**AH276**

**Functional Block Diagram**

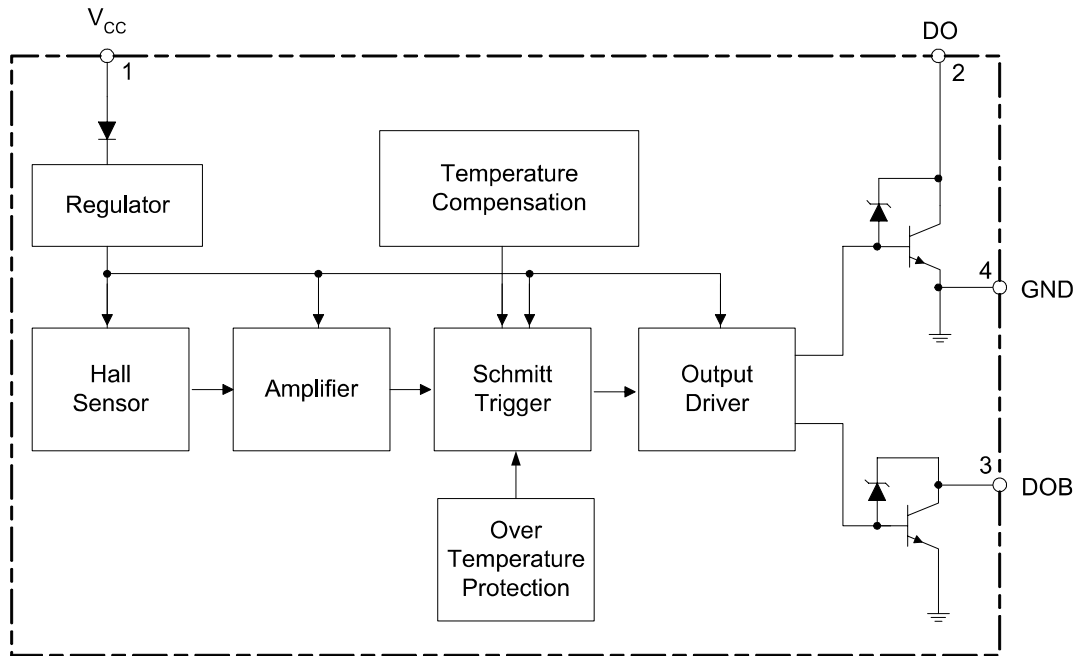
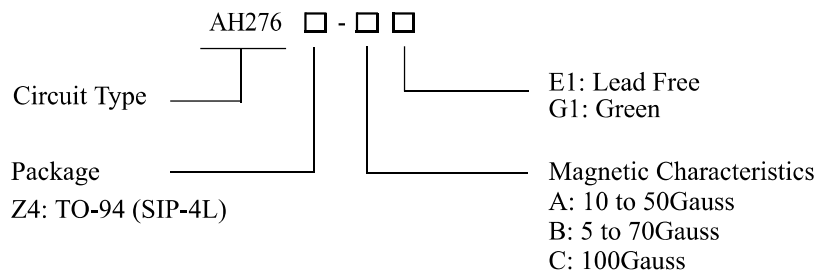

Figure 3. Functional Block Diagram of AH276

**Ordering Information**



Package	Temperature Range	Part Number		Marking ID		Packing Type
		Lead Free	Green	Lead Free	Green	
TO-94	-20 to 85 °C	AH276Z4-AE1	AH276Z4-AG1	AH276Z4-E1	AH276Z4-G1	Bulk
		AH276Z4-BE1	AH276Z4-BG1	AH276Z4-E1	AH276Z4-G1	Bulk
		AH276Z4-CE1	AH276Z4-CG1	AH276Z4-E1	AH276Z4-G1	Bulk

BCD Semiconductor's Pb-free products, as designated with "E1" suffix in the part number, are RoHS compliant. Products with "G1" suffix are available in green package.

**COMPLEMENTARY OUTPUT HALL EFFECT LATCH****AH276****Absolute Maximum Ratings (Note 1)** $(T_A=25^{\circ}\text{C})$ 

Parameter		Symbol	Value	Unit
Supply Voltage		$V_{CC}$	20	V
Reverse Protection Voltage		$V_{RCC}$	-20	V
Magnetic Flux Density		B	Unlimited	Gauss
Output Current	Continuous	$I_O$	350	mA
	Hold		550	mA
	Peak (start up)		750	mA
Power Dissipation		$P_D$	550	mW
Thermal Resistance	Die to atmosphere	$\theta_{JA}$	227	$^{\circ}\text{C}/\text{W}$
	Die to package case	$\theta_{JC}$	49	$^{\circ}\text{C}/\text{W}$
Storage Temperature		$T_{STG}$	-50 to 150	$^{\circ}\text{C}$
ESD (Machine Model)			300	V
ESD (Human Body Model)			2500	V

Note 1: Stresses greater than those listed under "Absolute Maximum Ratings" may cause permanent damage to the device. These are stress ratings only, and functional operation of the device at these or any other conditions beyond those indicated under "Recommended Operating Conditions" is not implied. "Absolute Maximum Ratings" for extended period may affect device reliability.

**Recommended Operating Conditions** $(T_A=25^{\circ}\text{C})$ 

Parameter	Symbol	Min	Max	Unit
Supply Voltage	$V_{CC}$	3.5	16	V
Ambient Temperature	$T_A$	-20	85	$^{\circ}\text{C}$



**COMPLEMENTARY OUTPUT HALL EFFECT LATCH**

**AH276**

**Electrical Characteristics**

( $T_A=25^{\circ}\text{C}$ ,  $V_{CC}=14\text{V}$ , unless otherwise specified)

Parameter	Symbol	Test Condition	Min	Typ	Max	Unit
Output Saturation Voltage	$V_{SAT}$	$V_{CC}=3.5\text{V}$ , $I_O=100\text{mA}$		0.3		V
		$I_O=350\text{mA}$		0.35	0.6	V
Output Leakage Current	$I_{OL}$	$V_{CE}=16\text{V}$		0.1	10	$\mu\text{A}$
Supply Current	$I_{CC}$	$V_{CC}=16\text{V}$ , Output Open		12	16	mA
Output Rise Time	$t_r$	$R_L=820\Omega$ , $C_L=20\text{pF}$		3.0	10	$\mu\text{s}$
Output Fall Time	$t_f$	$R_L=820\Omega$ , $C_L=20\text{pF}$		0.3	1.5	$\mu\text{s}$
Switch Time Differential	$\Delta t$	$R_L=820\Omega$ , $C_L=20\text{pF}$		3.0	10	$\mu\text{s}$
Output Zener Breakdown Voltage	$V_Z$			55		V
Thermal Protection Temperature	TSD			178		$^{\circ}\text{C}$
Thermal Protection Hysteresis	$\Delta\text{TSD}$			40		$^{\circ}\text{C}$

**Magnetic Characteristics**

( $T_A=25^{\circ}\text{C}$ )

Parameter	Symbol	Grade	Min	Typ	Max	Unit
Operating Point	$B_{OP}$	A	10		50	Gauss
		B	5		70	Gauss
		C			100	Gauss
Releasing Point	$B_{RP}$	A	-50		-10	Gauss
		B	-70		-5	Gauss
		C	-100			Gauss
Hysteresis	$B_{HYS}$			75		Gauss

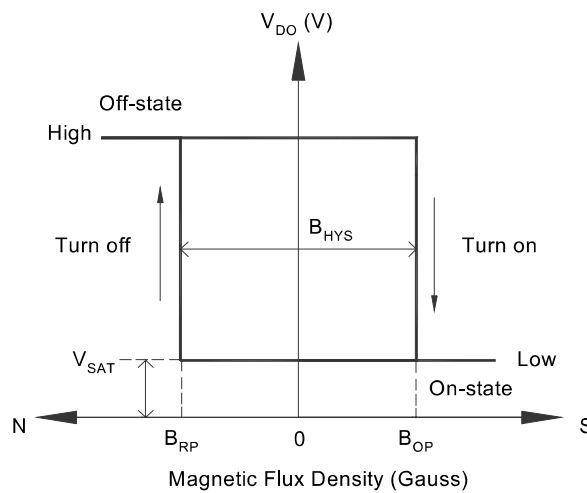

**COMPLEMENTARY OUTPUT HALL EFFECT LATCH**

**AH276**

**Magnetic Characteristics (Continued)**

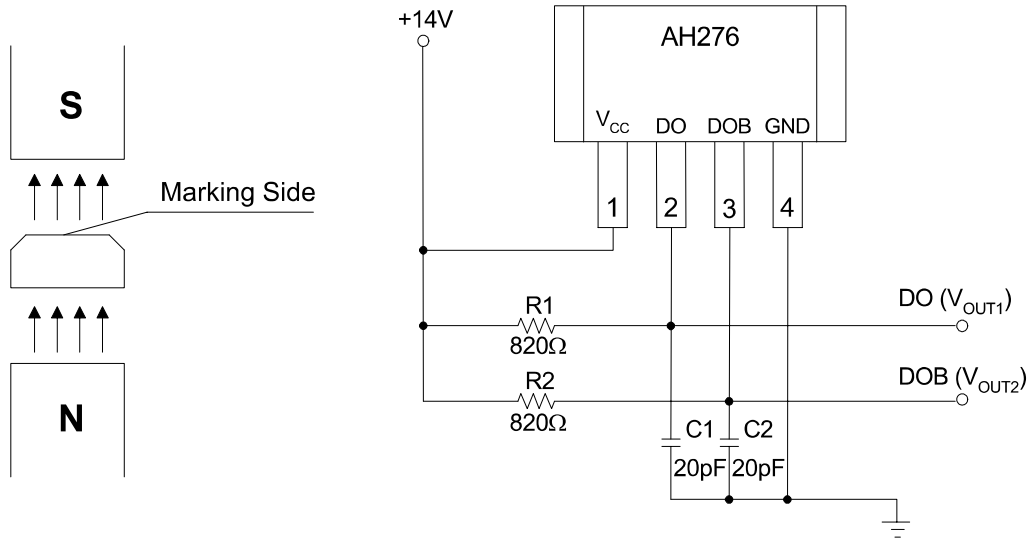

Figure 4. Basic Test Circuit

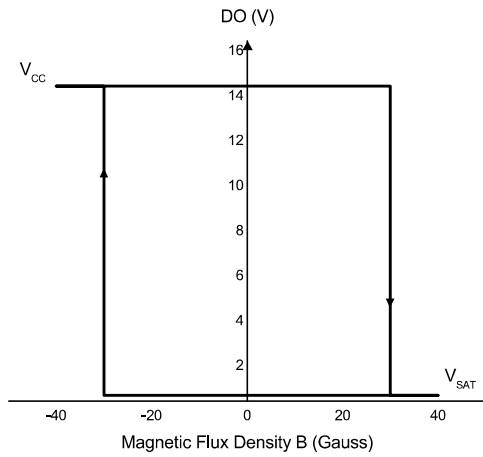

Figure 5.  $V_{DO}$  vs. Magnetic Flux Density

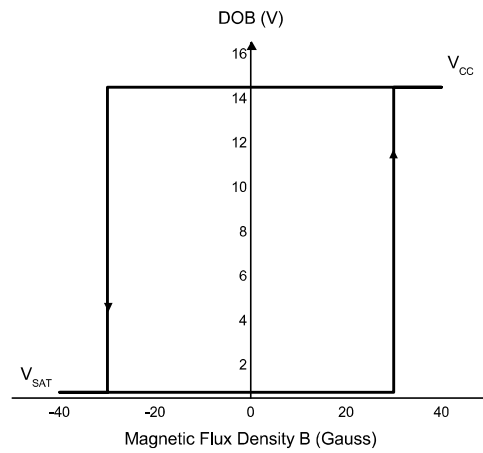

Figure 6.  $V_{DOB}$  vs. Magnetic Flux Density



**COMPLEMENTARY OUTPUT HALL EFFECT LATCH**

**AH276**

**Typical Performance Characteristics**

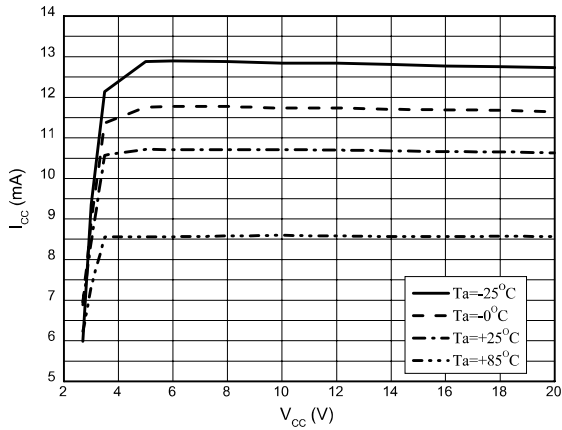

Figure 7.  $I_{CC}$  vs.  $V_{CC}$

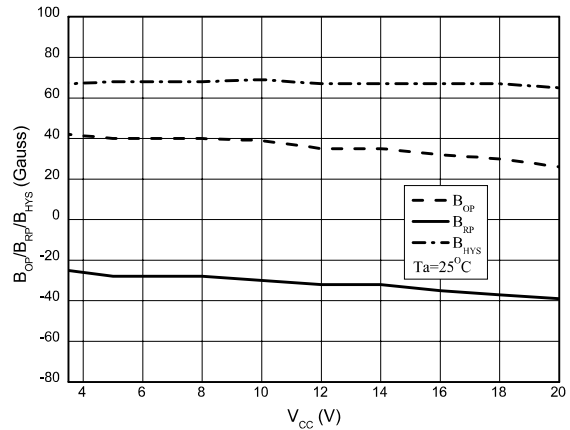

Figure 8.  $B_{OP}/B_{RP}/B_{HYS}$  vs.  $V_{CC}$

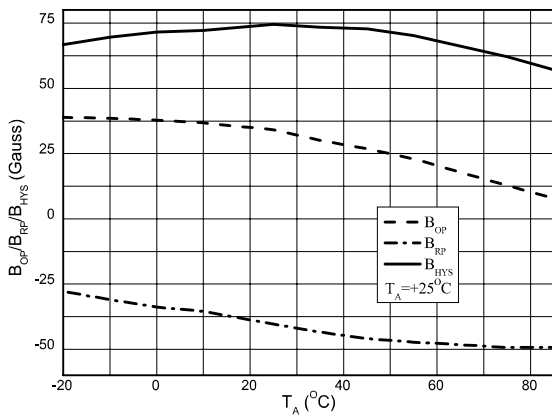

Figure 9.  $B_{OP}/B_{RP}/B_{HYS}$  vs. Ambient Temperature

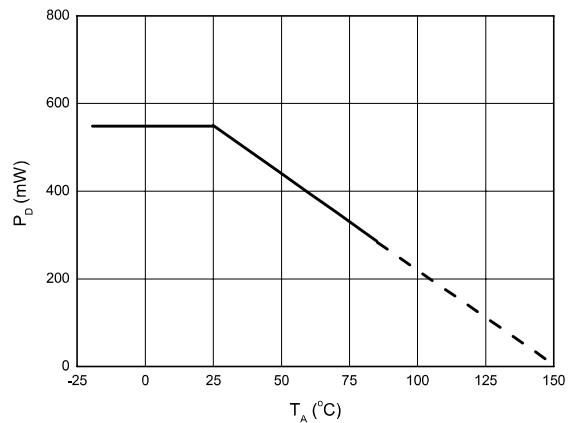

Figure 10.  $P_D$  vs. Ambient Temperature



**COMPLEMENTARY OUTPUT HALL EFFECT LATCH**

**AH276**

**Typical Performance Characteristics (Continued)**

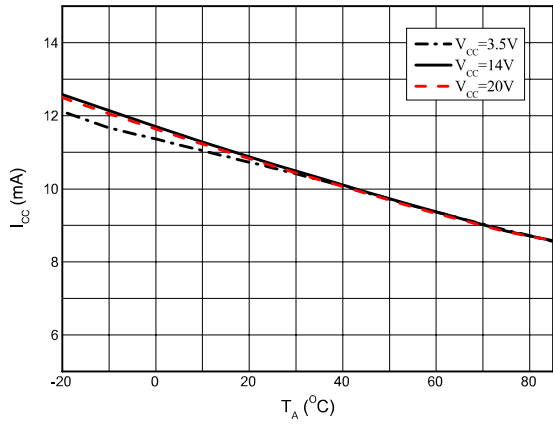

Figure 11.  $I_{CC}$  vs. Ambient Temperature

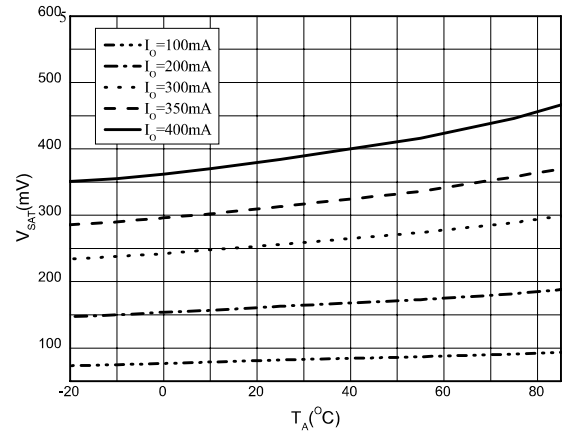

Figure 12.  $V_{SAT}$  vs. Ambient Temperature

**Typical Applications**

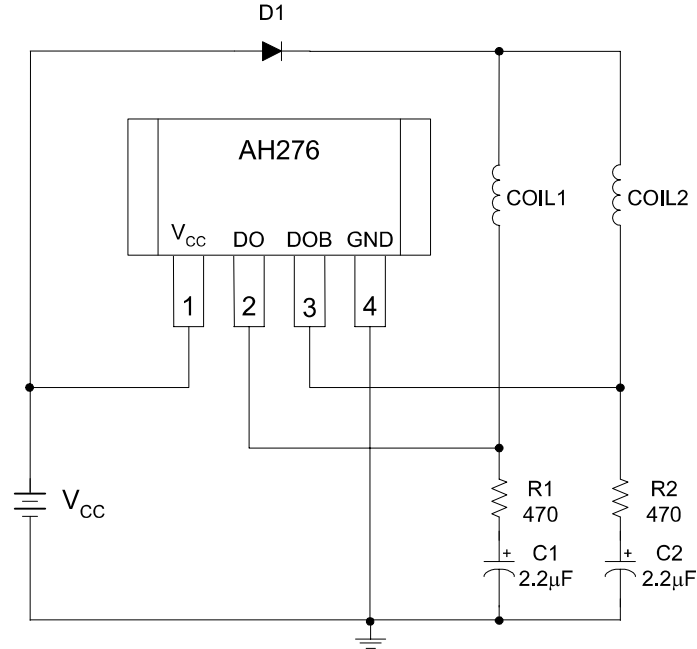

Figure 12. Typical Application Circuit





**COMPLEMENTARY OUTPUT HALL EFFECT LATCH**

**AH276**

**Mechanical Dimensions**

**TO-94**

**Unit: mm(inch)**

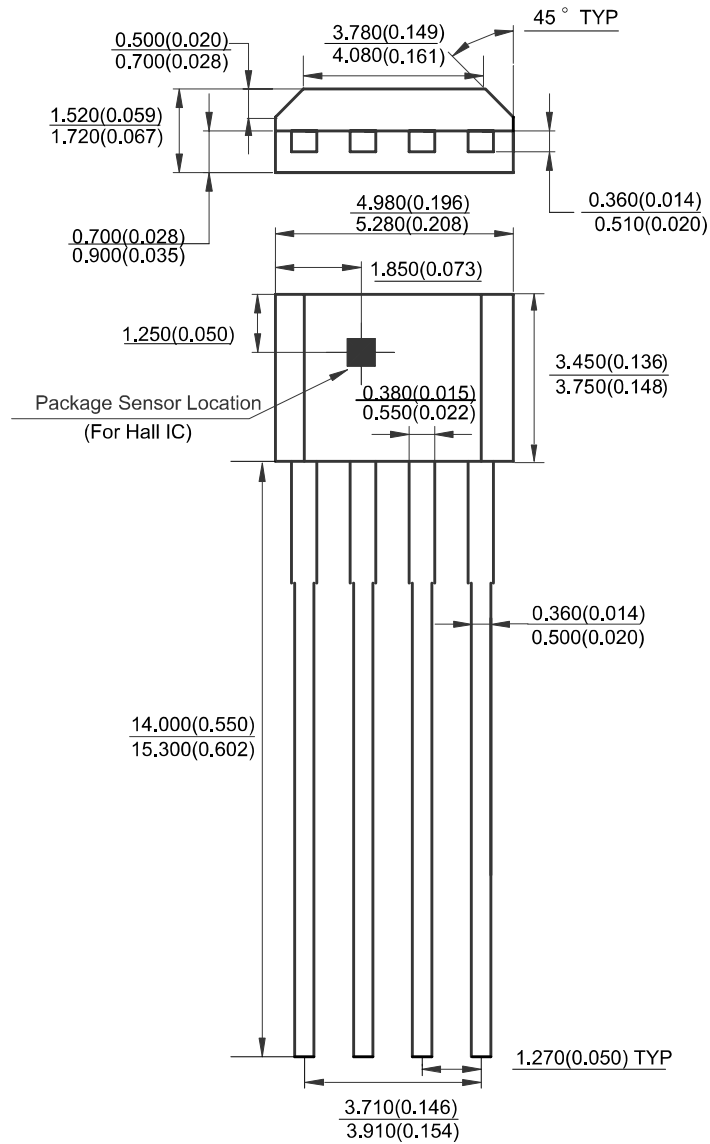



## **BCD Semiconductor Manufacturing Limited**

<http://www.bcdsemi.com>

### **IMPORTANT NOTICE**

BCD Semiconductor Manufacturing Limited reserves the right to make changes without further notice to any products or specifications herein. BCD Semiconductor Manufacturing Limited does not assume any responsibility for use of any its products for any particular purpose, nor does BCD Semiconductor Manufacturing Limited assume any liability arising out of the application or use of any its products or circuits. BCD Semiconductor Manufacturing Limited does not convey any license under its patent rights or other rights nor the rights of others.

---

#### **MAIN SITE**

##### **- Headquarters**

##### **BCD Semiconductor Manufacturing Limited**

No. 1600, Zi Xing Road, Shanghai Zizhu Science-based Industrial Park, 200241, China  
Tel: +86-21-24162266, Fax: +86-21-24162277

##### **- Wafer Fab**

##### **Shanghai SIM-BCD Semiconductor Manufacturing Co., Ltd.**

800 Yi Shan Road, Shanghai 200233, China  
Tel: +86-21-6485 1491, Fax: +86-21-5450 0008

#### **REGIONAL SALES OFFICE**

##### **Shenzhen Office**

##### **Shanghai SIM-BCD Semiconductor Manufacturing Co., Ltd., Shenzhen Office**

Unit A Room 1203, Skyworth Bldg., Gaoxin Ave.1.S., Nanshan District, Shenzhen, China  
Tel: +86-755-8826 7951  
Fax: +86-755-8826 7865

##### **Taiwan Office**

##### **BCD Semiconductor (Taiwan) Company Limited**

4F, 298-1, Rui Guang Road, Nei-Hu District, Taipei, Taiwan  
Tel: +886-2-2656 2808  
Fax: +886-2-2656 2806

##### **USA Office**

##### **BCD Semiconductor Corp.**

30920 Huntwood Ave. Hayward, CA 94544, USA  
Tel : +1-510-324-2988  
Fax: +1-510-324-2788