

TWO PHASE HALL EFFECT LATCH WITH FG OUTPUT**AH211****General Description**

The AH211 is an integrated Hall sensor with output driver and frequency generator designed for electronic commutation of brush-less DC motor applications. The device includes an on-chip Hall sensor for magnetic sensing, an amplifier that amplifies the Hall voltage, a Schmitt trigger to provide switching hysteresis for noise rejection, a temperature compensation circuit to compensate the temperature drift of Hall sensitivity, two complementary open-collector drivers for sinking large load current. It also includes an internal band-gap regulator which is used to provide bias voltage for internal circuits.

Place the device in a variable magnetic field, while the magnetic flux density is larger than threshold BOP, DO will be turned on (low) and DOB (and FG) will be turned off (high). This output state is held till the magnetic flux density reversal falls below BRP causing DO to be turned off (high) and DOB (and FG) turned on (low).

AH211 is available in TO-94 (SIP-4L) package.

Features

- On-Chip Hall Sensor
- 3.5V to 16V Supply Voltage
- 400mA (avg) Output Sink Current
- -20°C to 85°C Operating Temperature
- Built-in FG Output
- Low Profile TO-94 (SIP-4L) Package
- ESD Rating: 600V (Machine Model)

Applications

- Dual-Coil Brushless DC Motor
- Dual-Coil Brushless DC Fan
- Revolution Counting
- Speed Measurement

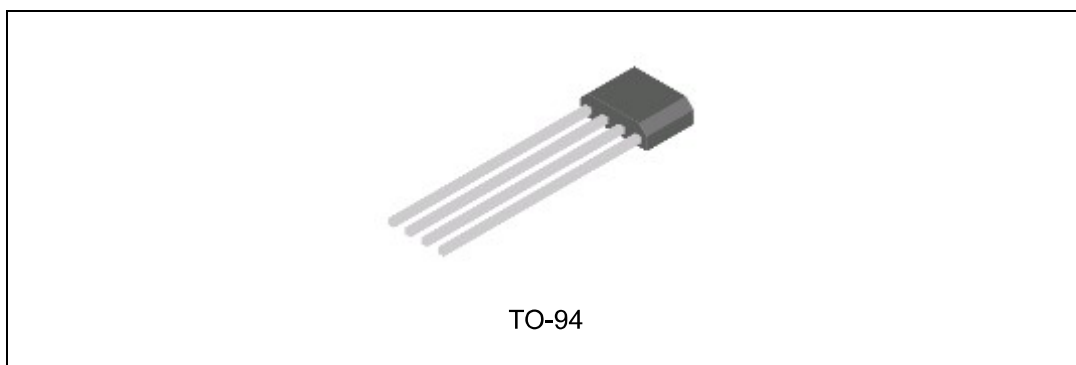

Figure 1. Package Type of AH211

TWO PHASE HALL EFFECT LATCH WITH FG OUTPUT

AH211

Pin Configuration

Z4 Package
(TO-94)

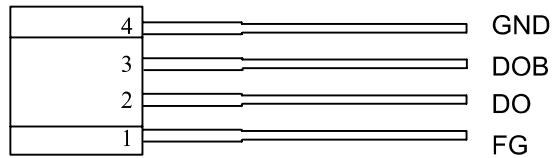

Figure 2. Pin Configuration of AH211 (Front View)

Pin Description

Pin Number	Pin Name	Function
1	FG	Frequency Generation
2	DO	Output 1
3	DOB	Output 2
4	GND	Ground

TWO PHASE HALL EFFECT LATCH WITH FG OUTPUT

AH211

Functional Block Diagram

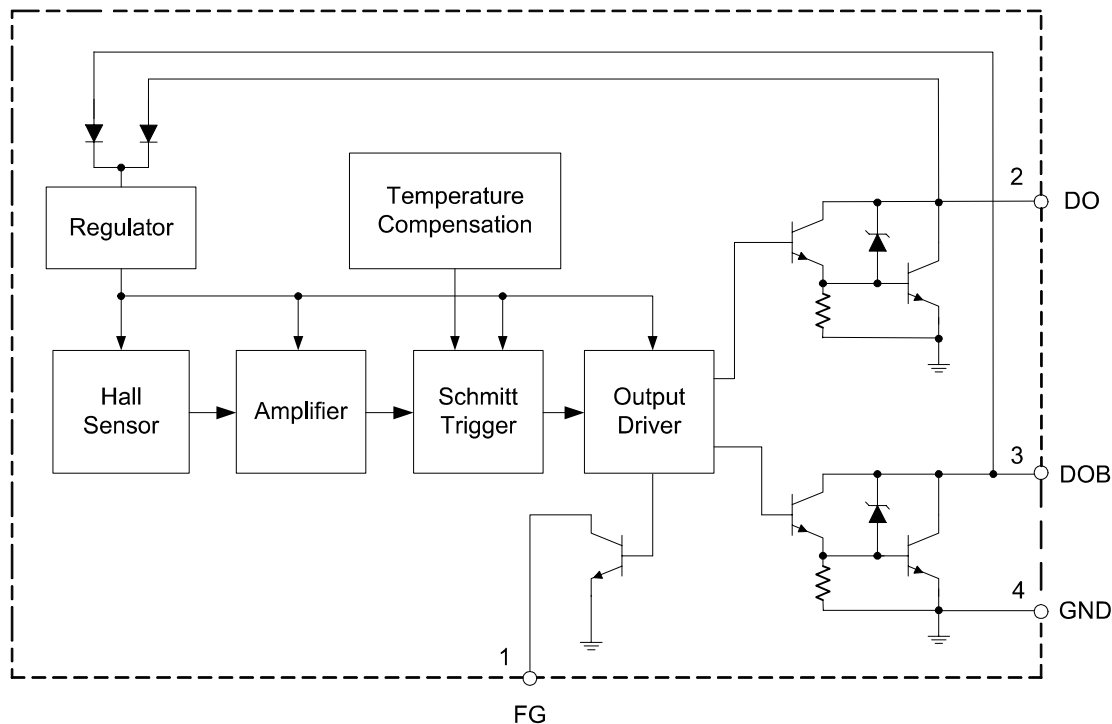
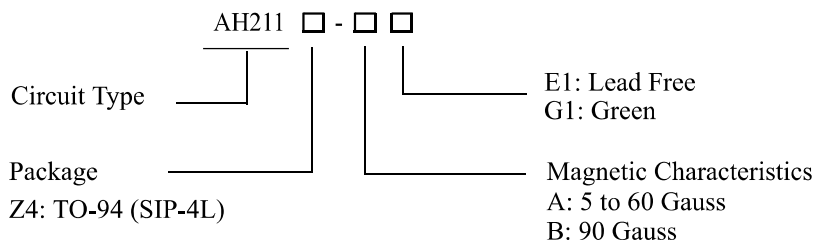

Figure 3. Functional Block Diagram of AH211

Ordering Information



Package	Temperature Range	Part Number		Marking ID		Packing Type
		Lead Free	Green	Lead Free	Green	
TO-94	-20 to 85 °C	AH211Z4-AE1	AH211Z4-AG1	AH211	AH211Z4-G1	Bulk
		AH211Z4-BE1	AH211Z4-BG1	AH211	AH211Z4-G1	Bulk

BCD Semiconductor's Pb-free products, as designated with "E1" suffix in the part number, are RoHS compliant. Products with "G1" suffix are available in green package.

**TWO PHASE HALL EFFECT LATCH WITH FG OUTPUT****AH211****Absolute Maximum Ratings (Note 1)** $(T_A=25^{\circ}\text{C})$

Parameter	Symbol	Value	Unit
Supply Voltage	V_{CC}	20	V
Magnetic Flux Density	B	Unlimited	Gauss
Output Current	I_O	Continuous	400 mA
		Hold	600 mA
		Peak (Start up)	800 mA
FG Voltage	V_{FG}	30	V
FG Current	I_{FG}	20	mA
Power Dissipation	P_D	550	mW
Thermal Resistance	Die to Atmosphere	θ_{JA}	227 $^{\circ}\text{C}/\text{W}$
	Die to Package Case	θ_{JC}	49 $^{\circ}\text{C}/\text{W}$
Storage Temperature	T_{STG}	-50 to 150	$^{\circ}\text{C}$
ESD (Machine Model)		600	V
ESD (Human Body Model)		6000	V

Note 1: Stresses greater than those listed under "Absolute Maximum Ratings" may cause permanent damage to the device. These are stress ratings only, and functional operation of the device at these or any other conditions beyond those indicated under "Recommended Operating Conditions" is not implied. "Absolute Maximum Ratings" for extended period may affect device reliability.

Recommended Operating Conditions $(T_A=25^{\circ}\text{C})$

Parameter	Symbol	Min	Max	Unit
Supply Voltage	V_{CC}	3.5	16	V
Ambient Temperature	T_A	-20	85	$^{\circ}\text{C}$



TWO PHASE HALL EFFECT LATCH WITH FG OUTPUT

AH211

Electrical Characteristics

($T_A=25^{\circ}C$, $V_{CC}=14V$, unless otherwise specified)

Parameter	Symbol	Test Condition	Min	Typ	Max	Unit
Output Saturation Voltage	V_{SAT}	B>150Gauss, $V_{CC}=3.5V$, $V_{DOB}=V_{CC}$, $I_{DO}=100mA$ (or B<-150Gauss, $V_{CC}=3.5V$, $V_{DO}=V_{CC}$, $I_{DOB}=100mA$)		1.1		V
		B>150Gauss, $V_{DOB}=V_{CC}$, $I_{DO}=400mA$ (or B<-150Gauss, $V_{DO}=V_{CC}$, $I_{DOB}=400mA$)		1.05	1.3	V
FG Saturation Voltage	V_{SATF}	B<-150Gauss, $V_{DO}=V_{CC}$, $I_{FG}=20mA$		0.35	0.6	V
FG Leakage Current	I_{OLF}	B>150Gauss, $V_{DOB}=V_{CC}$, $V_{FG}=16V$		0.1	10	μA
Supply Current	I_{CC}	B>150Gauss, $V_{DOB}=V_{CC}$, (or B<-150Gauss, $V_{DO}=V_{CC}$)		4	8	mA
Output Rise Time	tr	$R_L=1k\Omega$, $C_L=10pF$		3.0	10	μs
Output Fall Time	tf	$R_L=1k\Omega$, $C_L=10pF$		0.3	1.0	μs
Switch Time Differential	Δt	$R_L=1k\Omega$, $C_L=10pF$		3.0	10	μs
Output Zener Breakdown Voltage	V_Z			31		V

Magnetic Characteristics

($T_A=25^{\circ}C$)

Parameter	Symbol	Grade	Min	Typ	Max	Unit
Operating Point	B_{OP}	A	5	30	60	Gauss
		B			90	Gauss
Releasing Point	B_{RP}	A	-60	-30	-5	Gauss
		B	-90			Gauss
Hysteresis	B_{HYS}			60		Gauss

TWO PHASE HALL EFFECT LATCH WITH FG OUTPUT

AH211

Magnetic Characteristics (Continued)

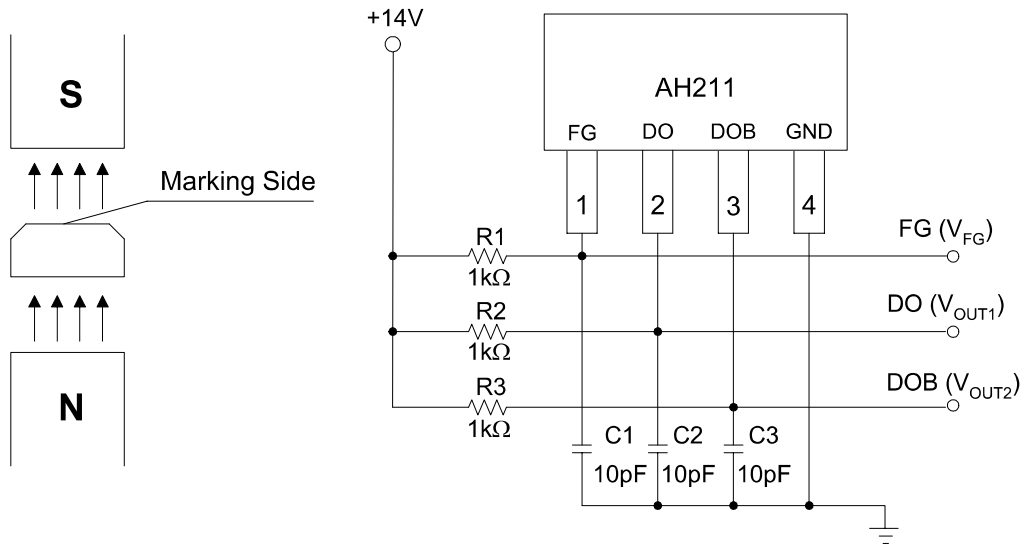

Figure 4. Basic Test Circuit

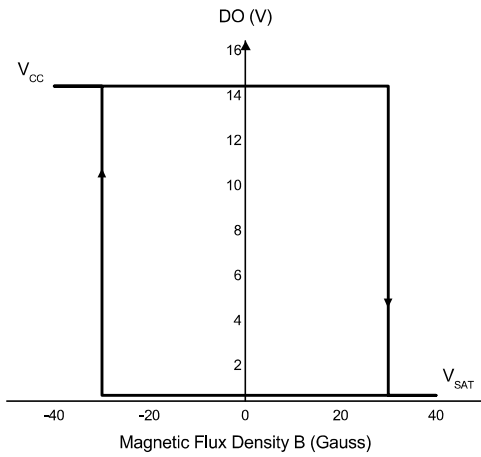

Figure 5. V_{DO} vs. Magnetic Flux Density

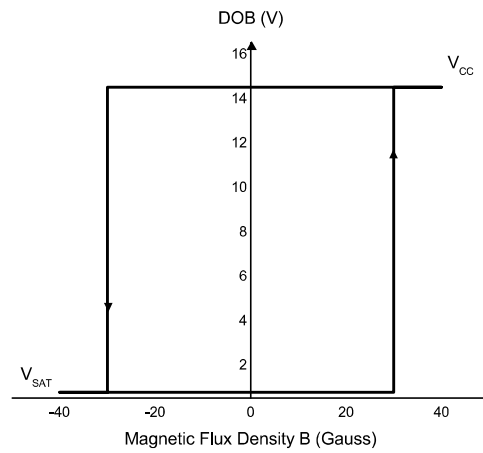

Figure 6. V_{DOB} vs. Magnetic Flux Density



TWO PHASE HALL EFFECT LATCH WITH FG OUTPUT

AH211

Typical Performance Characteristics

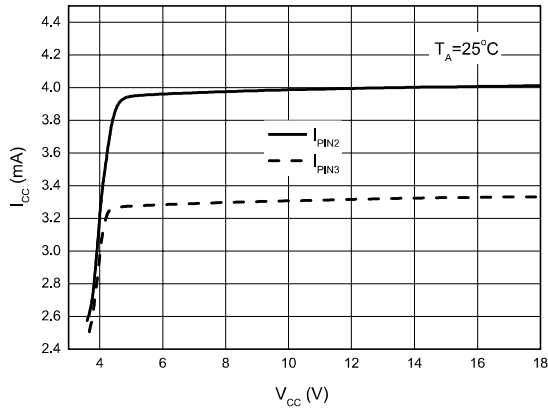

Figure 7. I_{CC} vs. V_{CC}

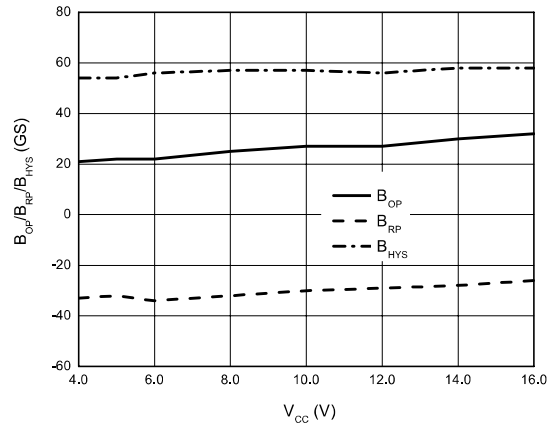

Figure 8. $B_{OP}/B_{RP}/B_{HYS}$ vs. V_{CC}

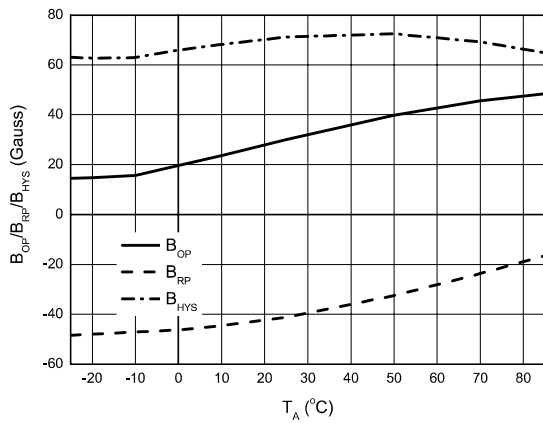

Figure 9. $B_{OP}/B_{RP}/B_{HYS}$ vs. Ambient Temperature

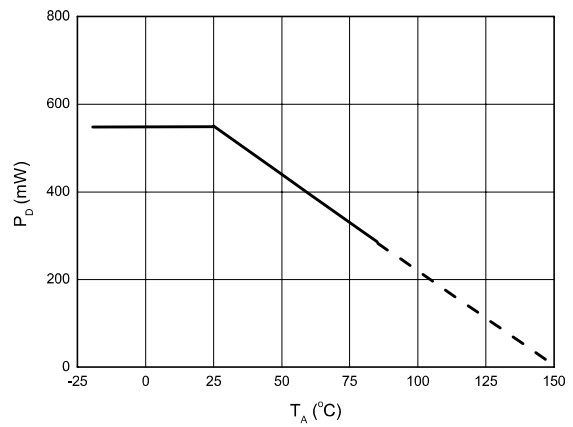

Figure 10. P_D vs. Ambient Temperature



TWO PHASE HALL EFFECT LATCH WITH FG OUTPUT

AH211

Typical Performance Characteristics (Continued)

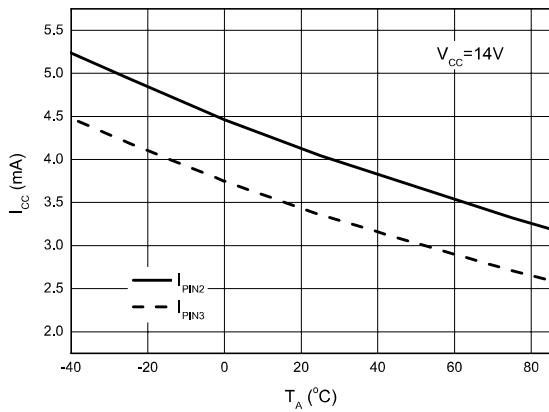

Figure 11. Supply Current vs. Ambient Temperature

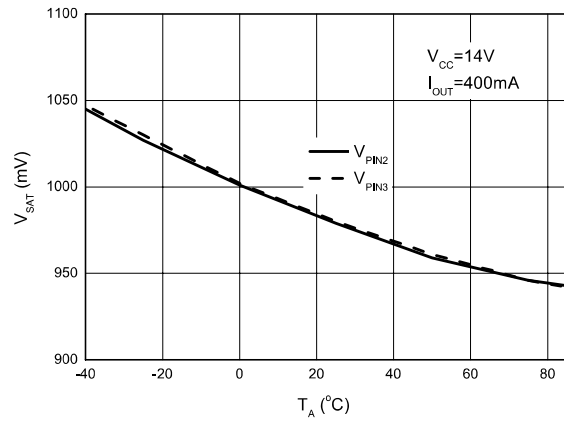

Figure 12. V_{SAT} vs. Ambient Temperature

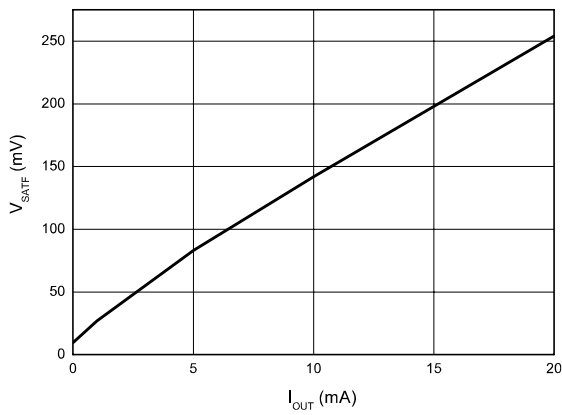

Figure 13. FG Saturation Voltage vs. Output Current

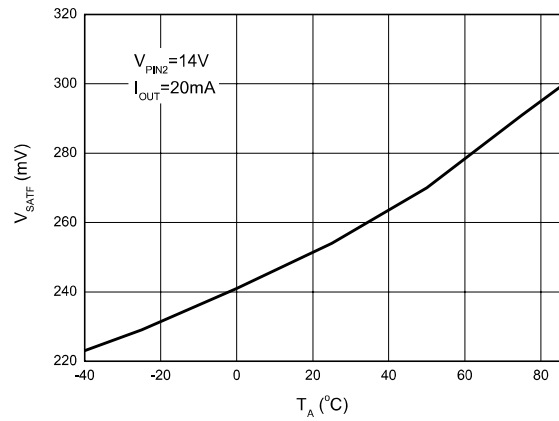

Figure 14. FG Saturation Voltage vs. Ambient Temperature

TWO PHASE HALL EFFECT LATCH WITH FG OUTPUT

AH211

Application Information

Figure 15 is the typical application circuit for AH211. Usually, there are three wires for fan connection: the red is input of power supply; the yellow is the output of FG; the black is the ground. R1 is an external pull-up resistor for the use of measuring FG signal from fan. The value of R1 could be decided by the transistor saturation voltage (V_{ON}), sink current (I_{FG}), and pull-up voltage (V_{DD}). The calculation formula is:

$$R1 = (V_{DD} - V_{ON}) / I_{FG}$$

For example:

$V_{DD} = 5V$ for TTL level.

If saturation voltage is $0.6V$ (IC specification)

$I_{FG} = 20mA$ ($\leq 20mA$), then $R1 = 220\Omega$;

If saturation voltage is $0.1V$, $I_{FG} = 1mA$ ($\leq 20mA$), the value of $R1 = 4.9k\Omega$

According AH211's specification, if $V_{DD} = 5V$, R1 must be larger than 220Ω

D1 is the reverse protection diode. If the red and black wires reversely connected, the current will flow from the ground via IC and coils L1 and L2 to power supply. Under such circumstances, the IC and coils are easy to be burned out. Therefore, the reverse protection diode D1 is necessary. However, D1 will also cause an extra voltage drop on the supply voltage.

C1 is a capacitor to reduce the ripple noise caused by the transient of the output stages. The amplitude of the ripple noise depends on the coil impedance and its characteristics.

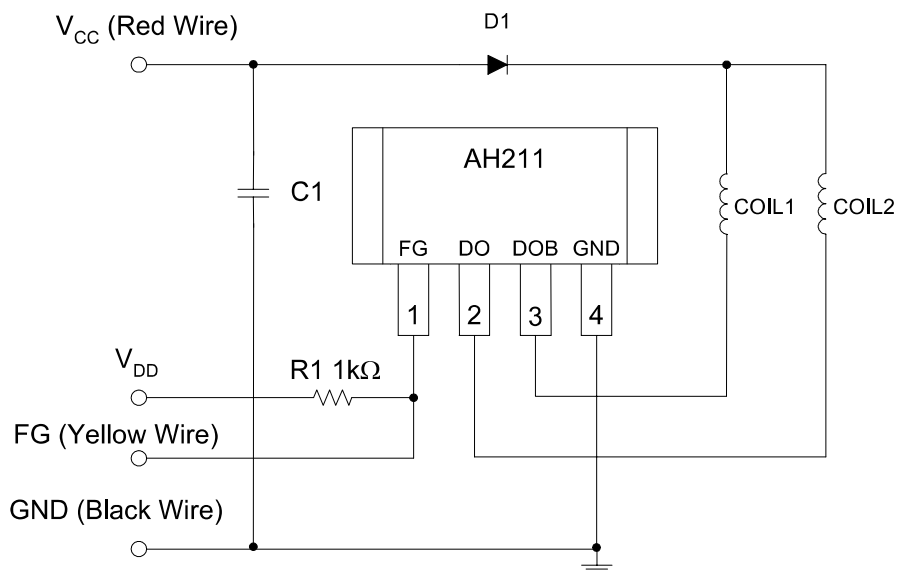

Figure 15. AH211 Typical Application Circuit



TWO PHASE HALL EFFECT LATCH WITH FG OUTPUT

AH211

Mechanical Dimensions

TO-94

Unit: mm(inch)

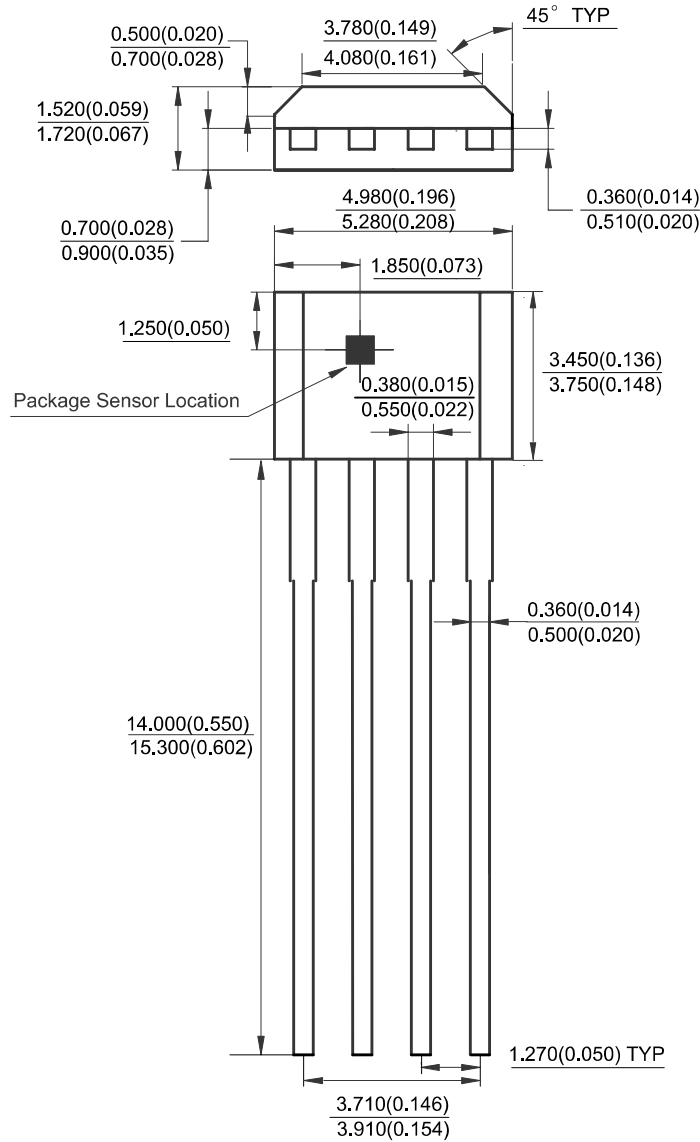



BCD Semiconductor Manufacturing Limited

<http://www.bcdsemi.com>

IMPORTANT NOTICE

BCD Semiconductor Manufacturing Limited reserves the right to make changes without further notice to any products or specifications herein. BCD Semiconductor Manufacturing Limited does not assume any responsibility for use of any its products for any particular purpose, nor does BCD Semiconductor Manufacturing Limited assume any liability arising out of the application or use of any its products or circuits. BCD Semiconductor Manufacturing Limited does not convey any license under its patent rights or other rights nor the rights of others.

MAIN SITE

- Headquarters

BCD Semiconductor Manufacturing Limited

No. 1600, Zi Xing Road, Shanghai Zizhu Science-based Industrial Park, 200241, China
Tel: +86-21-24162266, Fax: +86-21-24162277

- Wafer Fab

Shanghai SIM-BCD Semiconductor Manufacturing Co., Ltd.

800 Yi Shan Road, Shanghai 200233, China
Tel: +86-21-6485 1491, Fax: +86-21-5450 0008

REGIONAL SALES OFFICE

Shenzhen Office

Shanghai SIM-BCD Semiconductor Manufacturing Co., Ltd., Shenzhen Office

Unit A Room 1203, Skyworth Bldg., Gaoxin Ave.1.S., Nanshan District, Shenzhen, China
Tel: +86-755-8826 7951
Fax: +86-755-8826 7865

Taiwan Office

BCD Semiconductor (Taiwan) Company Limited

4F, 298-1, Rui Guang Road, Nei-Hu District, Taipei, Taiwan
Tel: +886-2-2656 2808
Fax: +886-2-2656 2806

USA Office

BCD Semiconductor Corp.

30920 Huntwood Ave. Hayward, CA 94544, USA
Tel : +1-510-324-2988
Fax: +1-510-324-2788