

## Description

The AH1389 is a miniature micropower magnetic Unipolar Hall effect switch IC with dual outputs specifically designed for portable and battery powered consumer equipment to home appliances and industrial applications. To support battery powered equipment and low voltage microcontrollers, the AH1389 can operate over the supply range of 1.6V to 3.6V and uses a sleep function to give an average supply current of only 4 $\mu$ A at 1.85V. The AH1389 has an 8kV ESD rating on the supply and output pins. To minimize PCB space the AH1389 is packaged in small low profile X2-DFN1410-4.

A North pole of sufficient strength will turn Output1 on and a South pole of sufficient strength will turn on Output2. The Output1 is turned on (pulled low) when the magnetic flux density (B), perpendicular to the part marking surface, falls below North field operate point  $B_{OPN}$  (-25G typical). The Output1 is held low until B rises above the North field release point  $B_{RPN}$  (-20G typical). Similarly, the Output2 will operate (pulled low) when B to the part marking surface rises above South field operate point  $B_{OPS}$  (25G typical) and is held low until B falls below the South field release point  $B_{RPS}$  (20G typical).

## Features

- Two Monolithic Unipolar Hall Switches
  - Operation with a North Pole (Output1) to Part Marking Surface
  - Operation with a South Pole (Output2) to Part Marking Surface
- Supply Voltage of 1.6V to 3.6V
- Micropower Operation
- Dual Outputs for Independent Pole Detection for Design Flexibility
- Internal Pull up and Pull Down Capability
- Chopper Stabilized Design
  - Superior Temperature Stability
  - Extremely Low Switch-Point Drift
  - Insensitive to Physical Stress
- Good RF Noise Immunity
- Operating Temperature Range -40°C to +85°C
- 8kV ESD on Supply and Output Pins
- Small Low Profile X2-DFN1410-4
- **Totally Lead-Free & Fully RoHS Compliant (Notes 1 & 2)**
- **Halogen and Antimony Free. "Green" Device (Note 3)**

- Notes:
1. No purposely added lead. Fully EU Directive 2002/95/EC (RoHS) & 2011/65/EU (RoHS 2) compliant.
  2. See [http://www.diodes.com/quality/lead\\_free.html](http://www.diodes.com/quality/lead_free.html) for more information about Diodes Incorporated's definitions of Halogen- and Antimony-free, "Green" and Lead-free.
  3. Halogen- and Antimony-free "Green" products are defined as those which contain <900ppm bromine, <900ppm chlorine (<1500ppm total Br + Cl) and <1000ppm antimony compounds.

## Pin Assignments

(Top View)

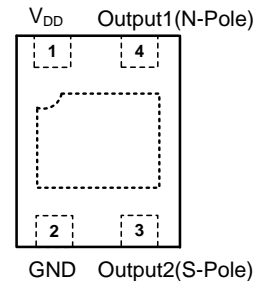

**X2-DFN1410-4**

## Applications

- Smart Cover or Dock Detect for Cellular Phones and Tablet
- Position Detect for Digital Still, Video Cameras and Handheld Gaming Consoles
- Door, Lids and Tray Position Detect Switches Home Appliances and Industrial Applications
- Level, Proximity and Position Switches
- Contact-Less Switches in Home Appliances and Industrial Applications

**Typical Applications Circuit**

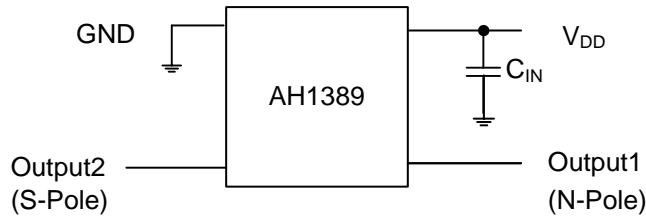

Note: 4.  $C_{IN}$  is for power stabilization and to strengthen the noise immunity, the recommended capacitance is 100nF typical and should be placed as close to the supply pin as possible.

**Pin Descriptions**

Package: X2-DFN1410-4

Pin Number	Pin Name	Function
1	$V_{DD}$	Power Supply Input
2	GND	Ground Pin
3	Output2	Output Pin(South-Pole)
4	Output1	Output Pin(North-Pole)
Pad	Pad	The center exposed pad should be tied to the GND or floating – No connection internally.

**Functional Block Diagram**

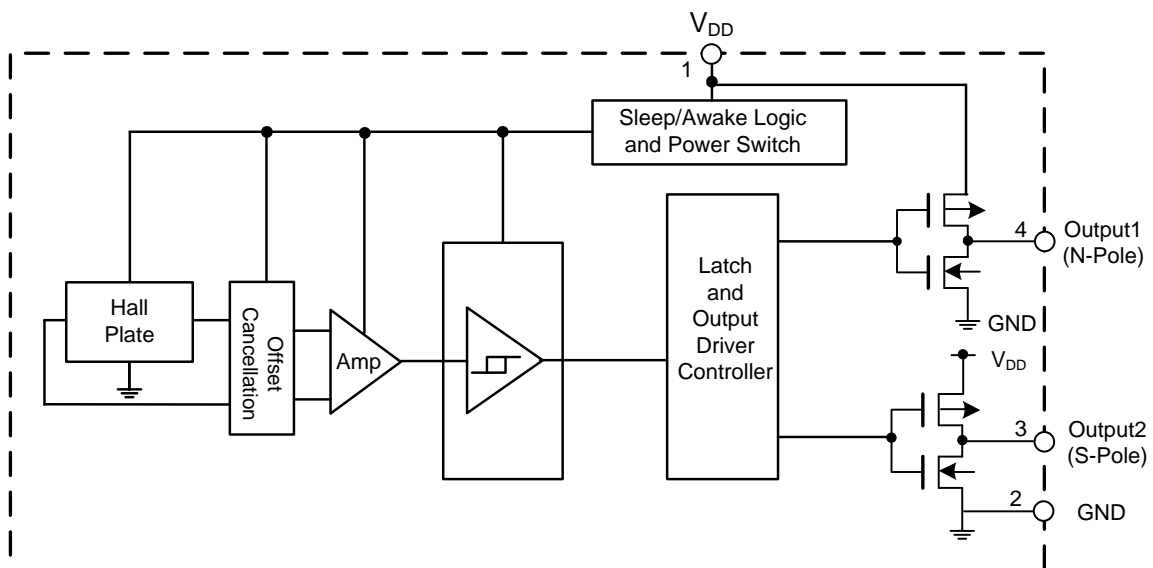

NEW PRODUCT

**Absolute Maximum Ratings** (Note 5) (@ $T_A = +25^\circ\text{C}$ , unless otherwise specified.)

Symbol	Parameter	Values	Unit
$V_{DD}$	Supply Voltage (Note 6)	6	V
$V_{DD\_REV}$	Reverse Supply Voltage	-0.3	V
$I_{OUTPUT}$	Output Current (Source and Sink)	2.5	mA
B	Magnetic Flux Density	Unlimited	
$P_D$	Package Power Dissipation	X2-DFN1410-4	230 mW
$T_{STG}$	Storage Temperature Range	-65 to +150	$^\circ\text{C}$
$T_J$	Maximum Junction Temperature	+150	$^\circ\text{C}$
ESD HBM	Human Body Model ESD Capability	8	kV

- Notes:
- Stresses greater than the 'Absolute Maximum Ratings' specified above may cause permanent damage to the device. These are stress ratings only; functional operation of the device at these or any other conditions exceeding those indicated in this specification is not implied. Device reliability may be affected by exposure to absolute maximum rating conditions for extended periods of time.
  - The absolute maximum  $V_{DD}$  of 6V is a transient stress rating and is not meant as a functional operating condition. It is not recommended to operate the device at the absolute maximum rated conditions for any period of time.

**Recommended Operating Conditions** (@ $T_A = +25^\circ\text{C}$ , unless otherwise specified.)

Symbol	Parameter	Conditions	Rating	Unit
$V_{DD}$	Supply Voltage	Operating	1.6 to 3.6	V
$T_A$	Operating Temperature Range	Operating	-40 to +85	$^\circ\text{C}$

**Electrical Characteristics** (@ $T_A = +25^\circ\text{C}$ , unless otherwise specified.)

Symbol	Parameter	Conditions	Min	Typ	Max	Unit
$V_{OL}$	Output Low Voltage (On)	$I_{OUT} = 1\text{mA}$	—	0.1	0.2	V
$V_{OH}$	Output High Voltage (Off)	$I_{OUT} = -1\text{mA}$	$V_{DD}-0.2$	$V_{DD}-0.1$	—	V
$I_{DD(AWAKE)}$	Supply Current	During 'Awake' Period, $T_A = +25^\circ\text{C}$ , $V_{DD} = 3\text{V}$	—	2.1	—	mA
$I_{DD(SLEEP)}$		During 'Sleep' Period, $T_A = +25^\circ\text{C}$ , $V_{DD} = 3\text{V}$	—	2.5	—	$\mu\text{A}$
$I_{DD(AVG)}$	Average Supply Current	$T_A = +25^\circ\text{C}$ , $V_{DD} = 1.85\text{V}$	—	4	8	$\mu\text{A}$
		$T_A = +25^\circ\text{C}$ , $V_{DD} = 3.6\text{V}$	—	7.2	13	$\mu\text{A}$
$t_{AWAKE}$	Awake Time	(Note 7)	—	50	100	$\mu\text{s}$
$t_{PERIOD}$	Period	(Note 7)	—	50	100	ms
D.C.	Duty Cycle	—	—	0.1	—	%

- Note: 7. When power is initially turned on, the operating  $V_{DD}$  (1.6V to 3.6V) must be applied to guaranteed the output sampling. The output state is valid after the second operating cycle (typical 100ms).

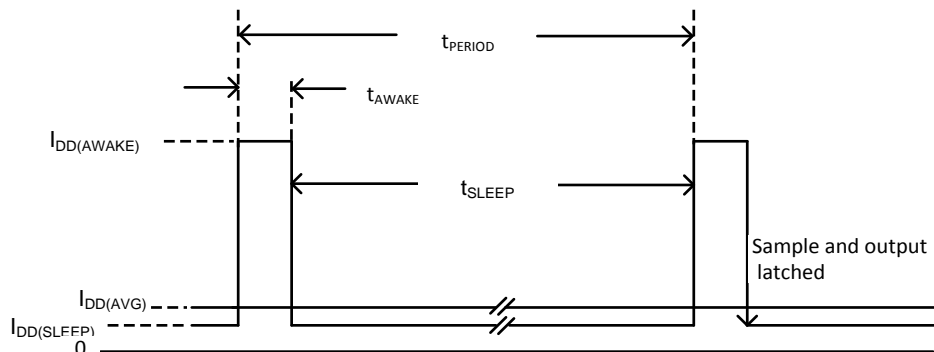

**Magnetic Characteristics** (Notes 8 & 9) ( $T_A = +25^\circ\text{C}$ ,  $V_{DD} = 1.85\text{V}$ , unless otherwise specified.)

Standard convention for representing the direction of magnetic field strength and flux density by positive and negative signs is as follows: Magnetic field and flux density from South pole magnet to the part marking surface of the sensor is positive. Magnetic field and flux density from the North pole magnet to the part marking surface is negative field. The positive and negative signs in below graph follow this standard convention. The positive and negative signs in the table below follow this standard convention.

(1mT=10 Gauss)

Symbol	Characteristics	Test Condition	Min	Typ	Max	Unit
$B_{OPS}$ (South Pole to Part Marking Side) Output2	Output2 Operation Point	$V_{DD} = 1.85\text{V}$ $T_A = +25^\circ\text{C}$	14	25	32	Gauss
		$V_{DD} = 1.6\text{V to } 3.6\text{V}$ $T_A = -40^\circ\text{C to } +85^\circ\text{C}$	13	25	39	
$B_{OPN}$ (North Pole to Part Marking Side) Output1	Output1 Operation Point	$V_{DD} = 1.85\text{V}$ $T_A = +25^\circ\text{C}$	-32	-25	-14	
		$V_{DD} = 1.6\text{V to } 3.6\text{V}$ $T_A = -40^\circ\text{C to } +85^\circ\text{C}$	-39	-25	-13	
$B_{RPS}$ (South Pole to Part Marking Side) Output2	Output2 Release Point	$V_{DD} = 1.85\text{V}$ $T_A = +25^\circ\text{C}$	12	20	30	
		$V_{DD} = 1.6\text{V to } 3.6\text{V}$ $T_A = -40^\circ\text{C to } +85^\circ\text{C}$	9	20	37	
$B_{RPN}$ (North Pole to Part Marking Side) Output1	Output1 Release Point	$V_{DD} = 1.85\text{V}$ $T_A = +25^\circ\text{C}$	-30	-20	-12	
		$V_{DD} = 1.6\text{V to } 3.6\text{V}$ $T_A = -40^\circ\text{C to } +85^\circ\text{C}$	-37	-20	-9	
$B_{HY}$ ( $ B_{OPX}  -  B_{RPX} $ )	Hysteresis (Note 10)	—	1	5	—	

- Notes:
- Typical data is at  $T_A = +25^\circ\text{C}$ ,  $V_{DD} = 1.85\text{V}$ .
  - Maximum and minimum parameter values over operating temperature range are not tested in production, they are guaranteed by design, characterization and process control. The magnetic characteristics may vary with supply voltage, operating temperature and after soldering.
  - Typical and minimum hysteresis is guaranteed by design and characterization.

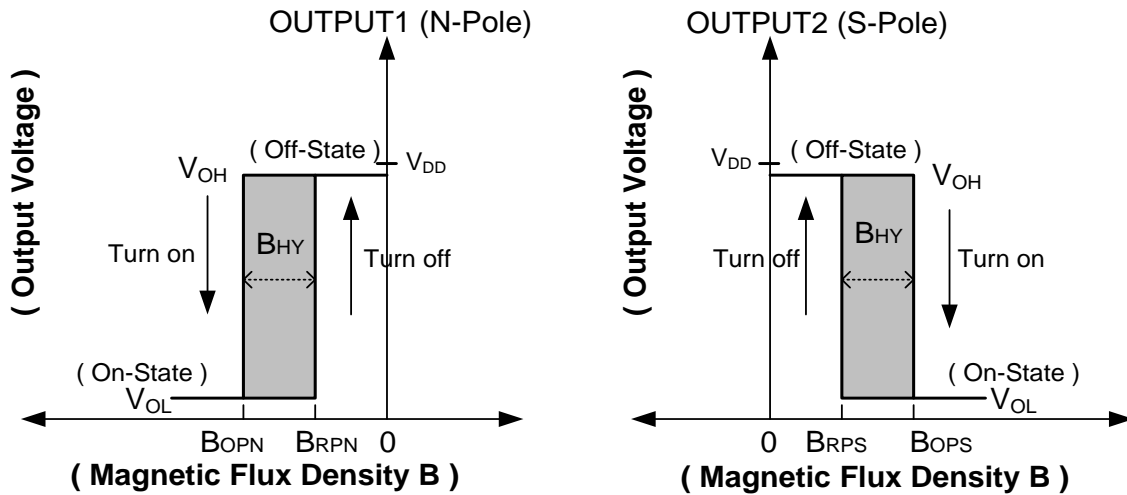

**Typical Operating Characteristics**

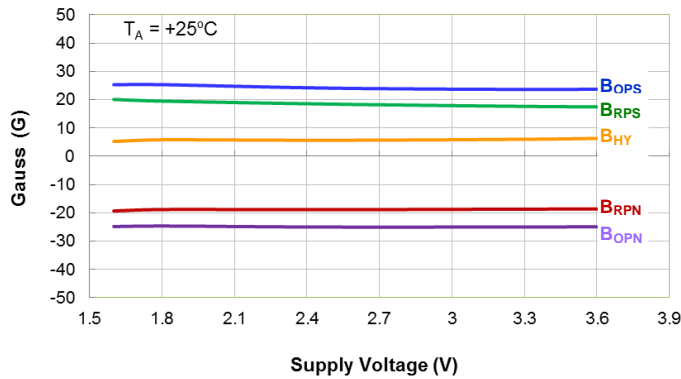

Switch Points  $B_{OP}$  and  $B_{RP}$  vs. Supply Voltage

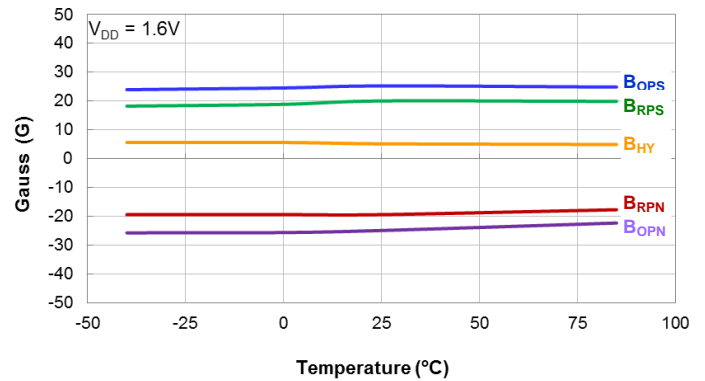

Switch Points  $B_{OP}$  and  $B_{RP}$  vs. Temperature

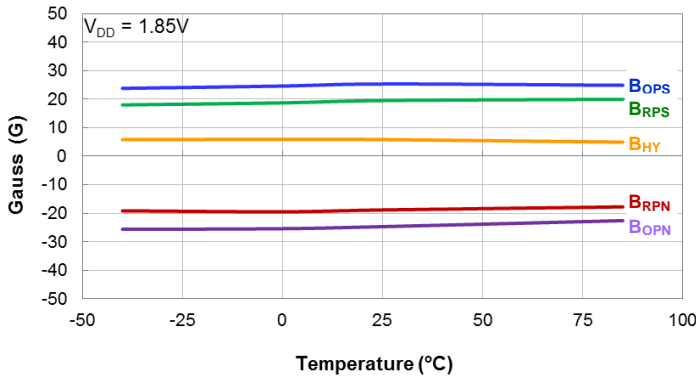

Switch Points  $B_{OP}$  and  $B_{RP}$  vs. Temperature

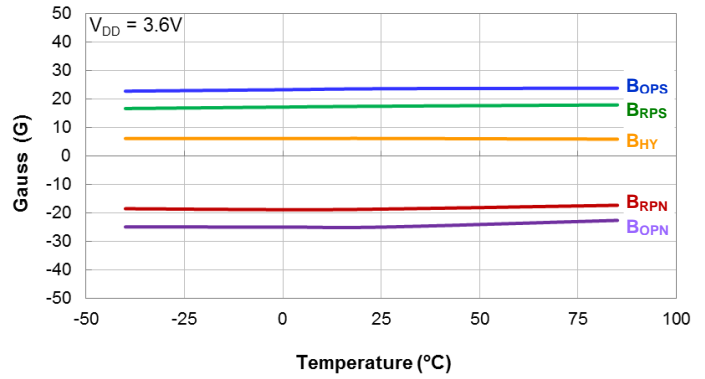

Switch Points  $B_{OP}$  and  $B_{RP}$  vs. Temperature

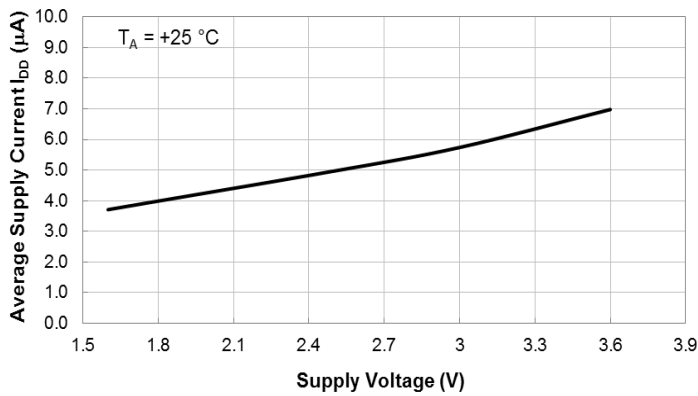

Average Supply Current vs Supply Voltage

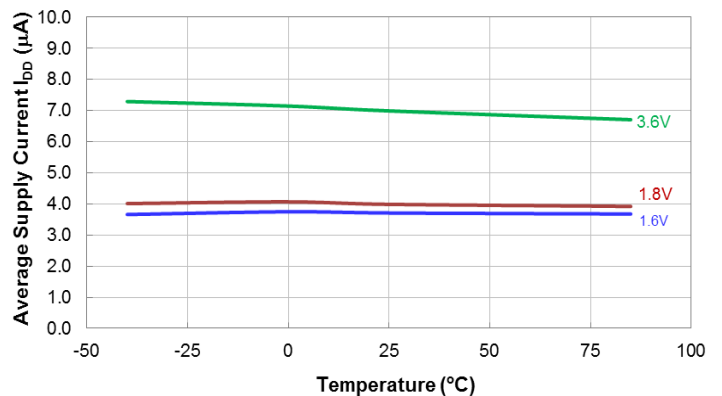

Average Supply Current vs Temperature

**Ordering Information**

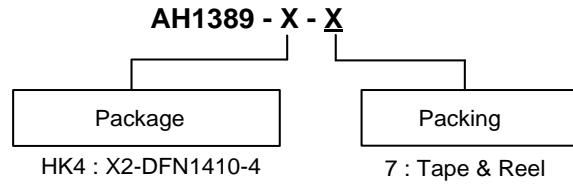

Part Number	Package Code	Packaging	7" Tape and Reel	
			Quantity	Part Number Suffix
AH1389-HK4-7	HK4	X2-DFN1410-4	4000/Tape & Reel	-7

**Marking Information**

(1) Package Type: X2-DFN1410-4

( Top View )

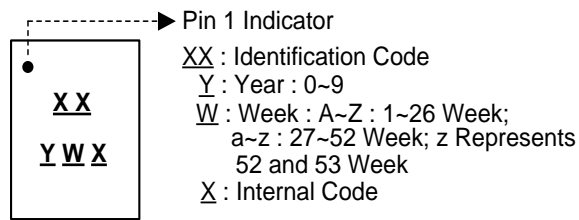

Part Number	Package	Identification Code
AH1389-HK4-7	X2-DFN1410-4	FG

**Package Outline Dimensions**

Please see <http://www.diodes.com/package-outlines.html> for the latest version.

(1) Package Type: X2-DFN1410-4

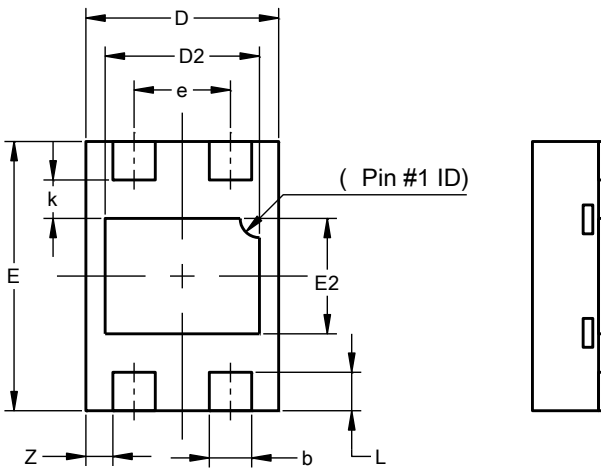
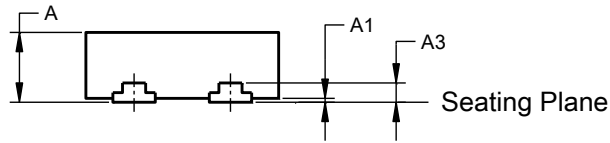

X2-DFN1410-4			
Dim	Min	Max	Typ
A	--	0.40	0.37
A1	0.00	0.05	0.02
A3	--	--	0.100
b	0.17	0.27	0.22
D	0.95	1.05	1.00
D2	0.70	0.90	0.80
E	1.35	1.45	1.40
E2	0.50	0.70	0.60
e	0.50BSC		
k	--	--	0.20
L	0.15	0.25	0.20
z	--	--	0.14
All Dimensions in mm			

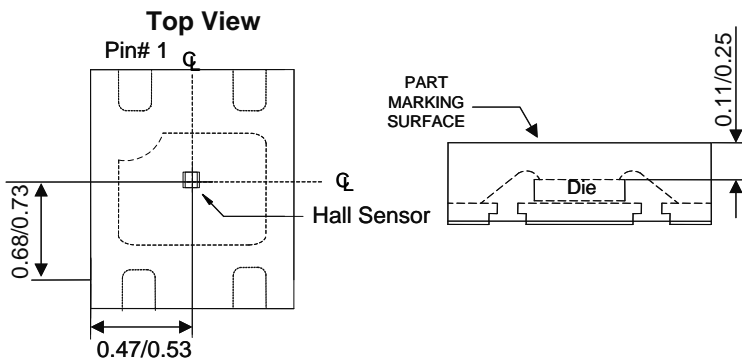

Sensor Location

NEW PRODUCT

## Suggested Pad Layout

Please see <http://www.diodes.com/package-outlines.html> for the latest version.

(1) Package Type: X2-DFN1410-4

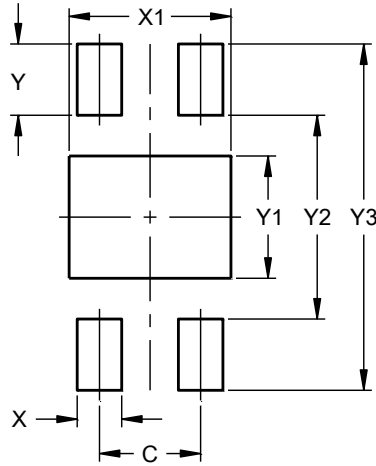

Dimensions	Value (in mm)
C	0.50
X	0.22
X1	0.80
Y	0.35
Y1	0.60
Y2	1.00
Y3	1.70



**IMPORTANT NOTICE**

DIODES INCORPORATED MAKES NO WARRANTY OF ANY KIND, EXPRESS OR IMPLIED, WITH REGARDS TO THIS DOCUMENT, INCLUDING, BUT NOT LIMITED TO, THE IMPLIED WARRANTIES OF MERCHANTABILITY AND FITNESS FOR A PARTICULAR PURPOSE (AND THEIR EQUIVALENTS UNDER THE LAWS OF ANY JURISDICTION).

Diodes Incorporated and its subsidiaries reserve the right to make modifications, enhancements, improvements, corrections or other changes without further notice to this document and any product described herein. Diodes Incorporated does not assume any liability arising out of the application or use of this document or any product described herein; neither does Diodes Incorporated convey any license under its patent or trademark rights, nor the rights of others. Any Customer or user of this document or products described herein in such applications shall assume all risks of such use and will agree to hold Diodes Incorporated and all the companies whose products are represented on Diodes Incorporated website, harmless against all damages.

Diodes Incorporated does not warrant or accept any liability whatsoever in respect of any products purchased through unauthorized sales channel. Should Customers purchase or use Diodes Incorporated products for any unintended or unauthorized application, Customers shall indemnify and hold Diodes Incorporated and its representatives harmless against all claims, damages, expenses, and attorney fees arising out of, directly or indirectly, any claim of personal injury or death associated with such unintended or unauthorized application.

Products described herein may be covered by one or more United States, international or foreign patents pending. Product names and markings noted herein may also be covered by one or more United States, international or foreign trademarks.

This document is written in English but may be translated into multiple languages for reference. Only the English version of this document is the final and determinative format released by Diodes Incorporated.

**LIFE SUPPORT**

Diodes Incorporated products are specifically not authorized for use as critical components in life support devices or systems without the express written approval of the Chief Executive Officer of Diodes Incorporated. As used herein:

A. Life support devices or systems are devices or systems which:

1. are intended to implant into the body, or
2. support or sustain life and whose failure to perform when properly used in accordance with instructions for use provided in the labeling can be reasonably expected to result in significant injury to the user.

B. A critical component is any component in a life support device or system whose failure to perform can be reasonably expected to cause the failure of the life support device or to affect its safety or effectiveness.

Customers represent that they have all necessary expertise in the safety and regulatory ramifications of their life support devices or systems, and acknowledge and agree that they are solely responsible for all legal, regulatory and safety-related requirements concerning their products and any use of Diodes Incorporated products in such safety-critical, life support devices or systems, notwithstanding any devices- or systems-related information or support that may be provided by Diodes Incorporated. Further, Customers must fully indemnify Diodes Incorporated and its representatives against any damages arising out of the use of Diodes Incorporated products in such safety-critical, life support devices or systems.

Copyright © 2017, Diodes Incorporated

[www.diodes.com](http://www.diodes.com)