

DATA SHEET

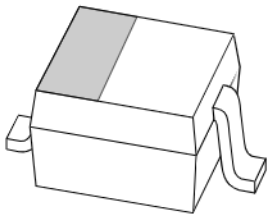

BAS321 General purpose diode

Product specification
Supersedes data of 1999 Feb 09

2004 Jan 26

General purpose diode

BAS321

FEATURES

- Small plastic SMD package
- Switching speed: max. 50 ns
- General application
- Continuous reverse voltage: max. 200 V
- Repetitive peak reverse voltage: max. 250 V
- Repetitive peak forward current: max. 625 mA.

APPLICATIONS

- General purpose switching in e.g. surface mounted circuits.

DESCRIPTION

The BAS321 is a general purpose diode fabricated in planar technology and encapsulated in a plastic SOD323 package.

PINNING

PIN	DESCRIPTION
1	cathode
2	anode

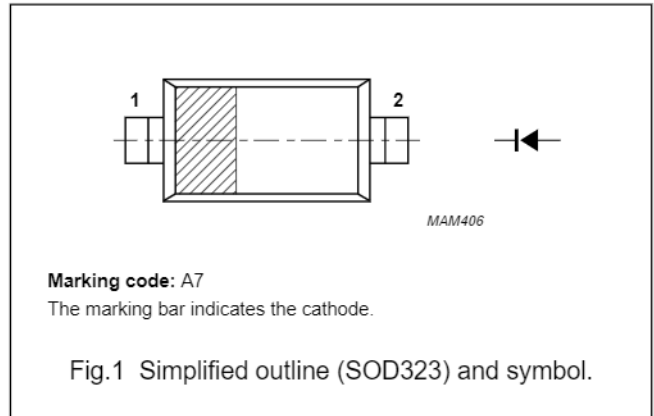

ORDERING INFORMATION

TYPE NUMBER	PACKAGE		
	NAME	DESCRIPTION	VERSION
BAS321	-	plastic surface mounted package; 2 leads	SOD323

LIMITING VALUES

In accordance with the Absolute Maximum Rating System (IEC 60134).

SYMBOL	PARAMETER	CONDITIONS	MIN.	MAX.	UNIT
V_{RRM}	repetitive peak reverse voltage		-	250	V
V_R	continuous reverse voltage		-	200	V
I_F	continuous forward current	see Fig.2; note 1	-	250	mA
I_{FRM}	repetitive peak forward current	$t_p < 0.5$ ms; $\delta \leq 0.25$	-	625	mA
I_{FSM}	non-repetitive peak forward current	square wave; $T_j = 25$ °C prior to surge; see Fig.4			
		$t = 1$ μ s	-	9	A
		$t = 100$ μ s	-	3	A
		$t = 10$ ms	-	1.7	A
P_{tot}	total power dissipation	$T_{amb} = 25$ °C; note 1	-	300	mW
T_{stg}	storage temperature		-65	+150	°C
T_j	junction temperature		-	150	°C

Note

1. Device mounted on an FR4 printed circuit-board.

General purpose diode

BAS321

CHARACTERISTICS $T_j = 25\text{ °C}$ unless otherwise specified.

SYMBOL	PARAMETER	CONDITIONS	MAX.	UNIT
V_F	forward voltage	see Fig.3 $I_F = 100\text{ mA}$ $I_F = 200\text{ mA}$	1 1.25	V V
I_R	reverse current	see Fig.5 $V_R = 200\text{ V}$ $V_R = 200\text{ V}; T_j = 150\text{ °C}$	100 100	nA μA
C_d	diode capacitance	$f = 1\text{ MHz}; V_R = 0$; see Fig.6	2	pF
t_{rr}	reverse recovery time	when switched from $I_F = 30\text{ mA}$ to $I_R = 30\text{ mA}; R_L = 100\ \Omega$; measured at $I_R = 3\text{ mA}$; see Fig.8	50	ns

THERMAL CHARACTERISTICS

SYMBOL	PARAMETER	CONDITIONS	VALUE	UNIT
$R_{th(j-s)}$	thermal resistance from junction to soldering point	$T_s = 90\text{ °C}$; note 1	130	K/W
$R_{th(j-a)}$	thermal resistance from junction to ambient	note 2	366	K/W

Notes

1. Soldering point of cathode tab.
2. Device mounted on an FR4 printed circuit board.

General purpose diode

BAS321

GRAPHICAL DATA

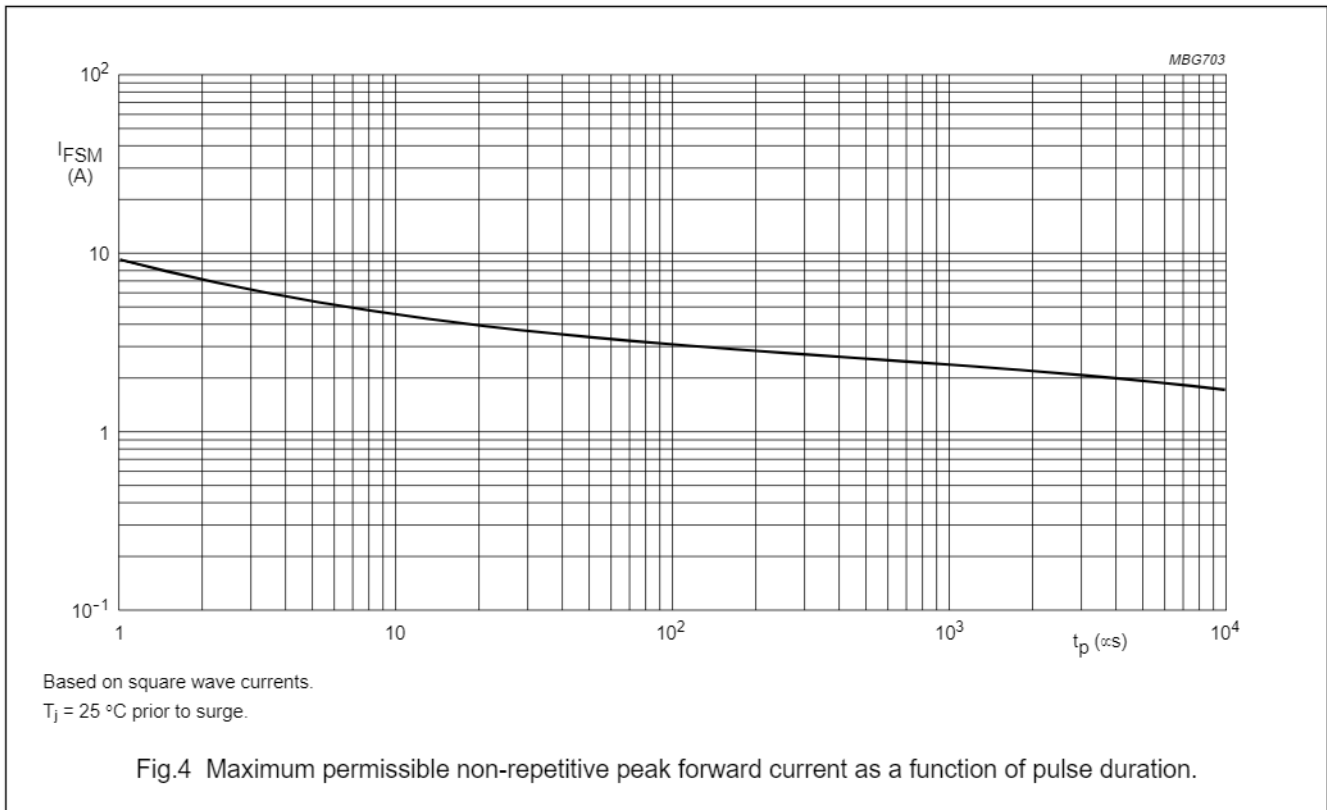
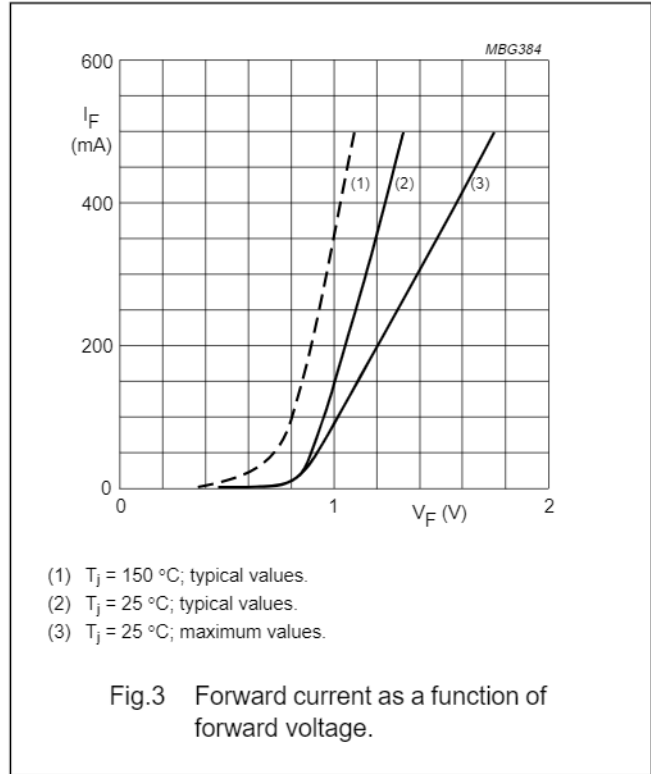
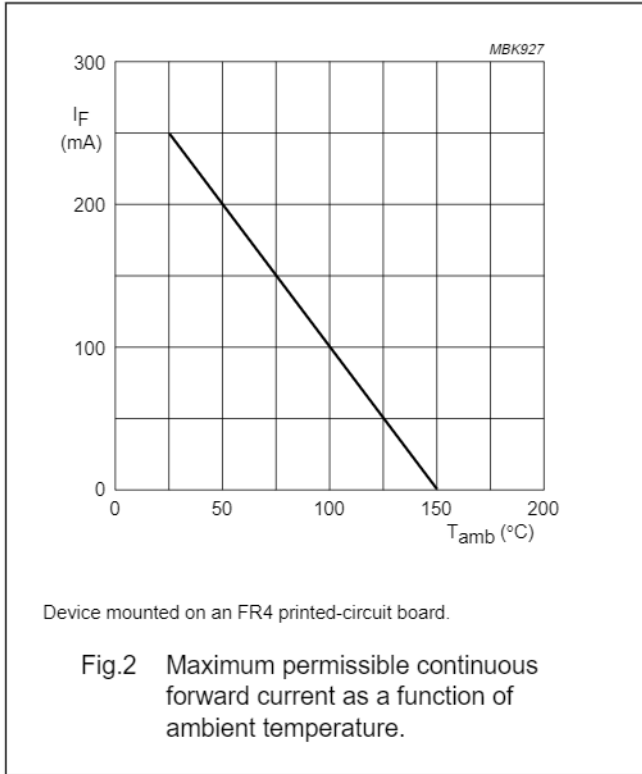

General purpose diode

BAS321

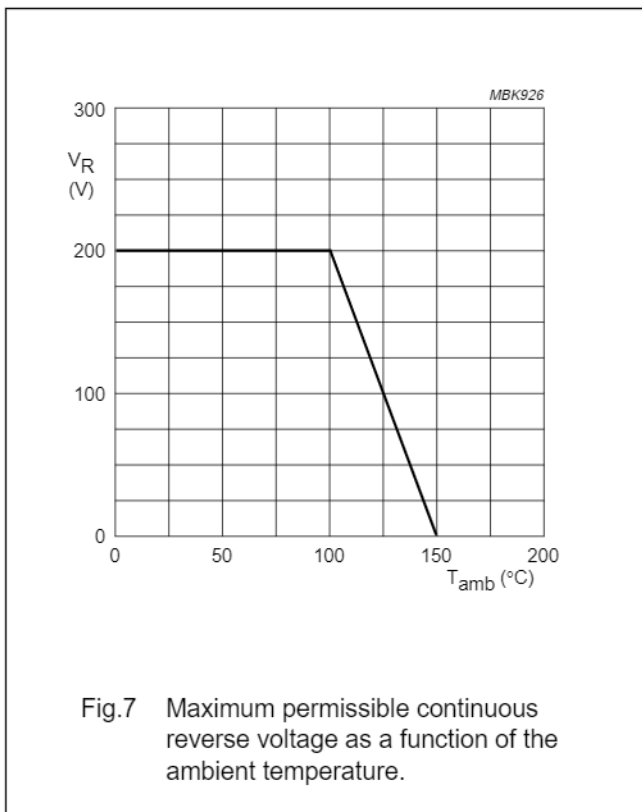
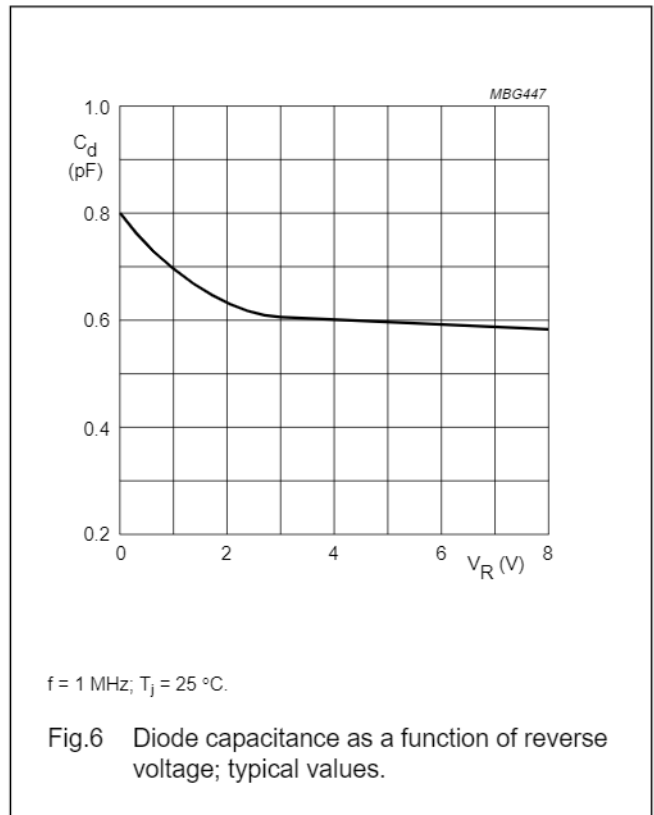
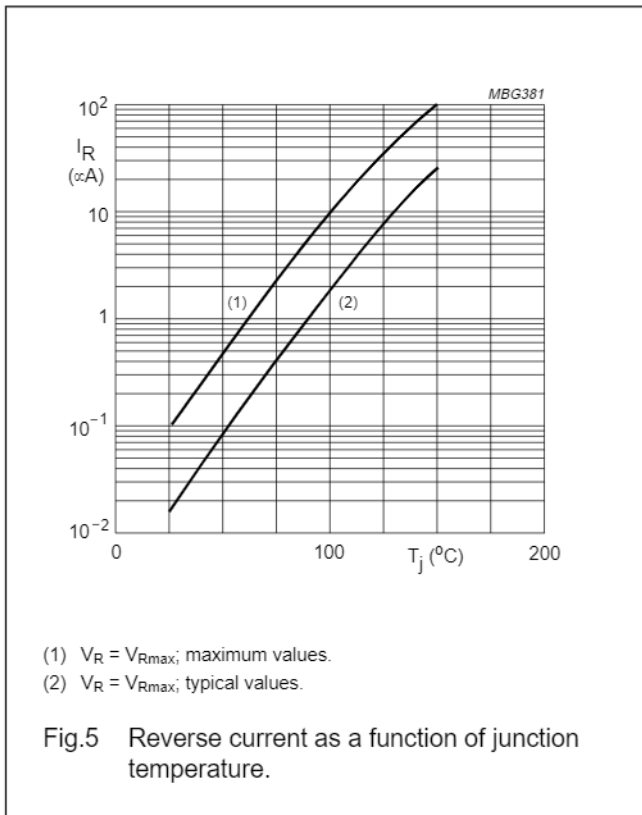

General purpose diode

BAS321

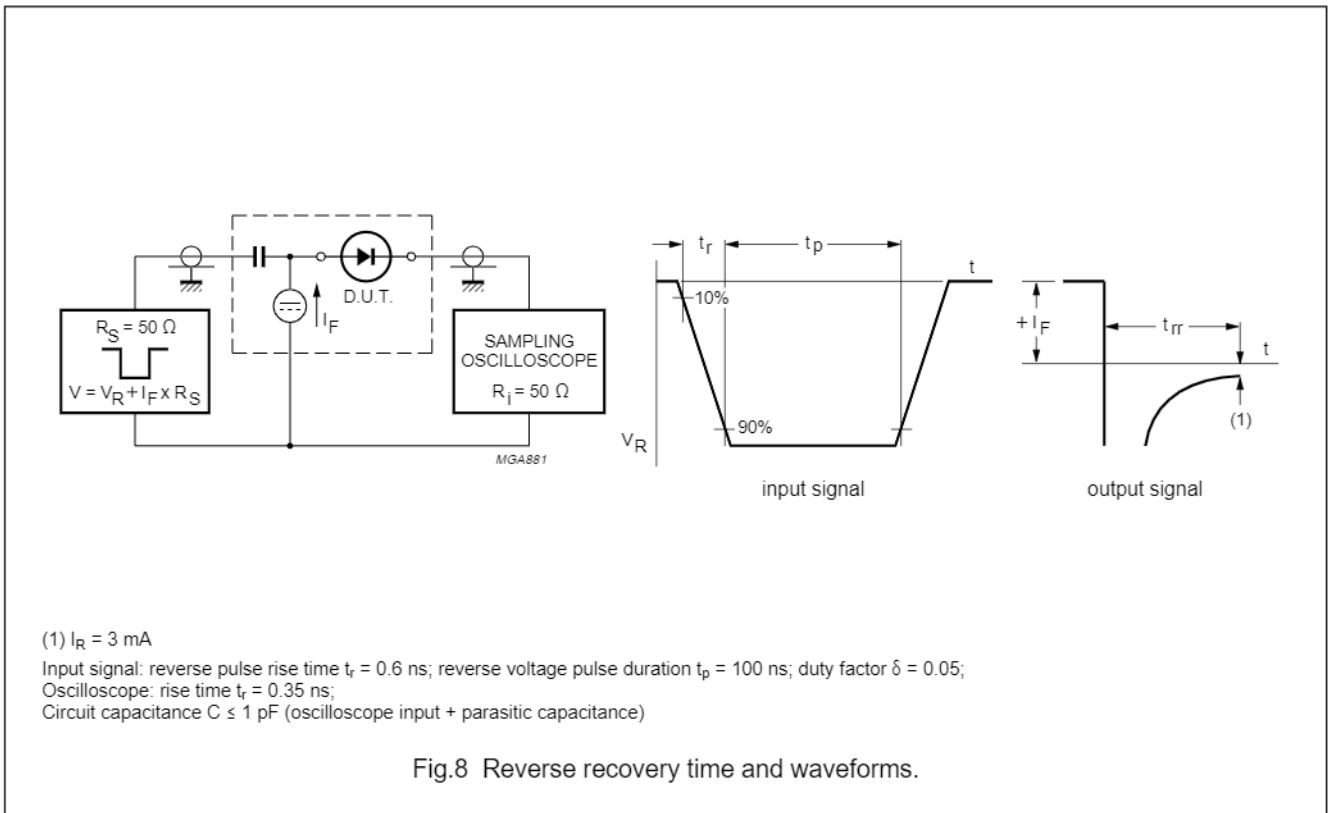

General purpose diode

BAS321

PACKAGE OUTLINE

Plastic surface mounted package; 2 leads

SOD323

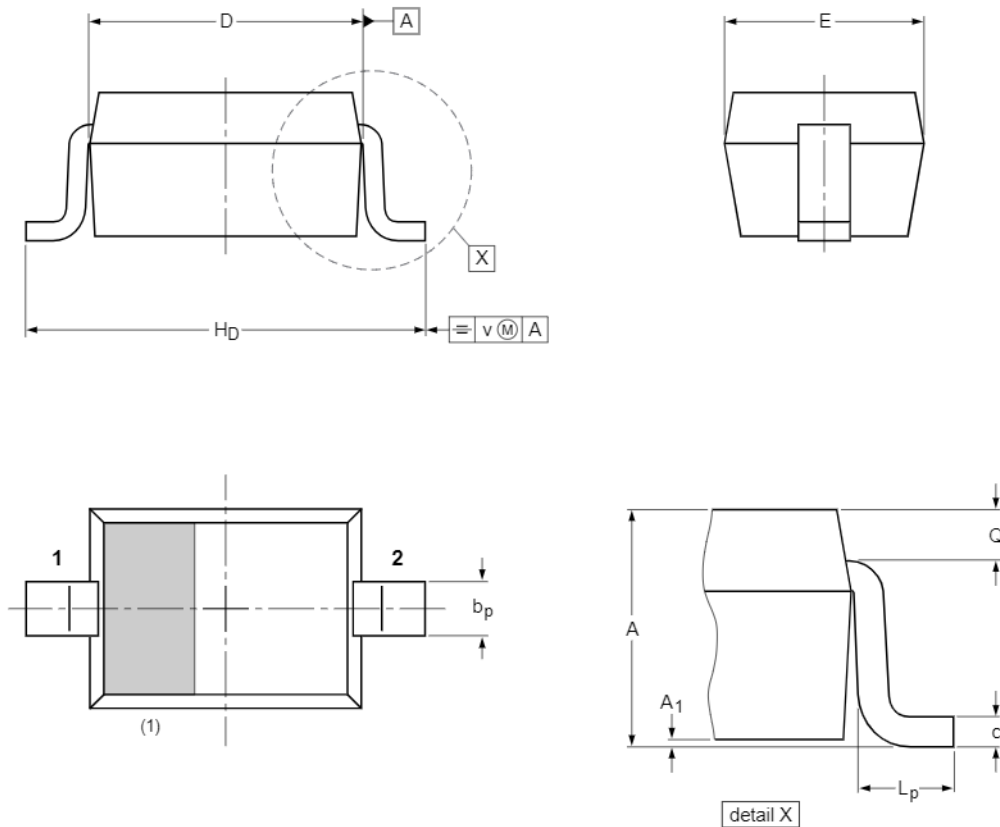

DIMENSIONS (mm are the original dimensions)

UNIT	A	A ₁ max	b _p	c	D	E	H _D	L _p	Q	v
mm	1.1 0.8	0.05	0.40 0.25	0.25 0.10	1.8 1.6	1.35 1.15	2.7 2.3	0.45 0.15	0.25 0.15	0.2

Note

1. The marking bar indicates the cathode

OUTLINE VERSION	REFERENCES			EUROPEAN PROJECTION	ISSUE DATE
	IEC	JEDEC	JEITA		
SOD323			SC-76		99-09-13 03-12-17

General purpose diode

BAS321

DATA SHEET STATUS

LEVEL	DATA SHEET STATUS ⁽¹⁾	PRODUCT STATUS ⁽²⁾⁽³⁾	DEFINITION
I	Objective data	Development	This data sheet contains data from the objective specification for product development. Philips Semiconductors reserves the right to change the specification in any manner without notice.
II	Preliminary data	Qualification	This data sheet contains data from the preliminary specification. Supplementary data will be published at a later date. Philips Semiconductors reserves the right to change the specification without notice, in order to improve the design and supply the best possible product.
III	Product data	Production	This data sheet contains data from the product specification. Philips Semiconductors reserves the right to make changes at any time in order to improve the design, manufacturing and supply. Relevant changes will be communicated via a Customer Product/Process Change Notification (CPCN).

Notes

1. Please consult the most recently issued data sheet before initiating or completing a design.
2. The product status of the device(s) described in this data sheet may have changed since this data sheet was published. The latest information is available on the Internet at URL <http://www.semiconductors.philips.com>.
3. For data sheets describing multiple type numbers, the highest-level product status determines the data sheet status.

DEFINITIONS

Short-form specification □ The data in a short-form specification is extracted from a full data sheet with the same type number and title. For detailed information see the relevant data sheet or data handbook.

Limiting values definition □ Limiting values given are in accordance with the Absolute Maximum Rating System (IEC 60134). Stress above one or more of the limiting values may cause permanent damage to the device.

These are stress ratings only and operation of the device at these or at any other conditions above those given in the Characteristics sections of the specification is not implied. Exposure to limiting values for extended periods may affect device reliability.

Application information □ Applications that are described herein for any of these products are for illustrative purposes only. Philips Semiconductors make no representation or warranty that such applications will be suitable for the specified use without further testing or modification.

DISCLAIMERS

Life support applications □ These products are not designed for use in life support appliances, devices, or systems where malfunction of these products can reasonably be expected to result in personal injury. Philips Semiconductors customers using or selling these products for use in such applications do so at their own risk and agree to fully indemnify Philips Semiconductors for any damages resulting from such application.

Right to make changes □ Philips Semiconductors reserves the right to make changes in the products - including circuits, standard cells, and/or software - described or contained herein in order to improve design and/or performance. When the product is in full production (status 'Production'), relevant changes will be communicated via a Customer Product/Process Change Notification (CPCN). Philips Semiconductors assumes no responsibility or liability for the use of any of these products, conveys no licence or title under any patent, copyright, or mask work right to these products, and makes no representations or warranties that these products are free from patent, copyright, or mask work right infringement, unless otherwise specified.

Philips Semiconductors – a worldwide company

Contact information

For additional information please visit <http://www.semiconductors.philips.com>. Fax: +31 40 27 24825
For sales offices addresses send e-mail to: sales.addresses@www.semiconductors.philips.com.

© Koninklijke Philips Electronics N.V. 2004

SCA76

All rights are reserved. Reproduction in whole or in part is prohibited without the prior written consent of the copyright owner.

The information presented in this document does not form part of any quotation or contract, is believed to be accurate and reliable and may be changed without notice. No liability will be accepted by the publisher for any consequence of its use. Publication thereof does not convey nor imply any license under patent- or other industrial or intellectual property rights.

Printed in The Netherlands

R76/02/pp9

Date of release: 2004 Jan 26

Document order number: 9397 750 12589

Let's make things better.

**Philips
Semiconductors**



PHILIPS