

Kinghelm®

Rev.	ECN Number	Description	Date	Drawn	Checkd	Approved

技术要求:

1. 材质: 不锈钢SUS304, $T=0.08\pm0.005$;
- ▼ 2. 端子锡脚焊接面和接触面不可有毛边, 其他部位毛边最大0.03mm;
3. 扭曲: $45^\circ/1000\text{mm}$, 拱形 $5\text{mm}/1000\text{mm}$;
4. 标示有"▼"符号的为重点控制和检验尺寸;
5. 未标注之R MAX R0.13;
6. 电镀须满足48小时盐雾测试;
7. 寿命测试>2万次, 产品弹力要求在60gf~80gf之间
8. 镍底50~80u"min, 焊接区域镀金, 接触区域镀金1U"MIN

∅0.70 吸盘位置

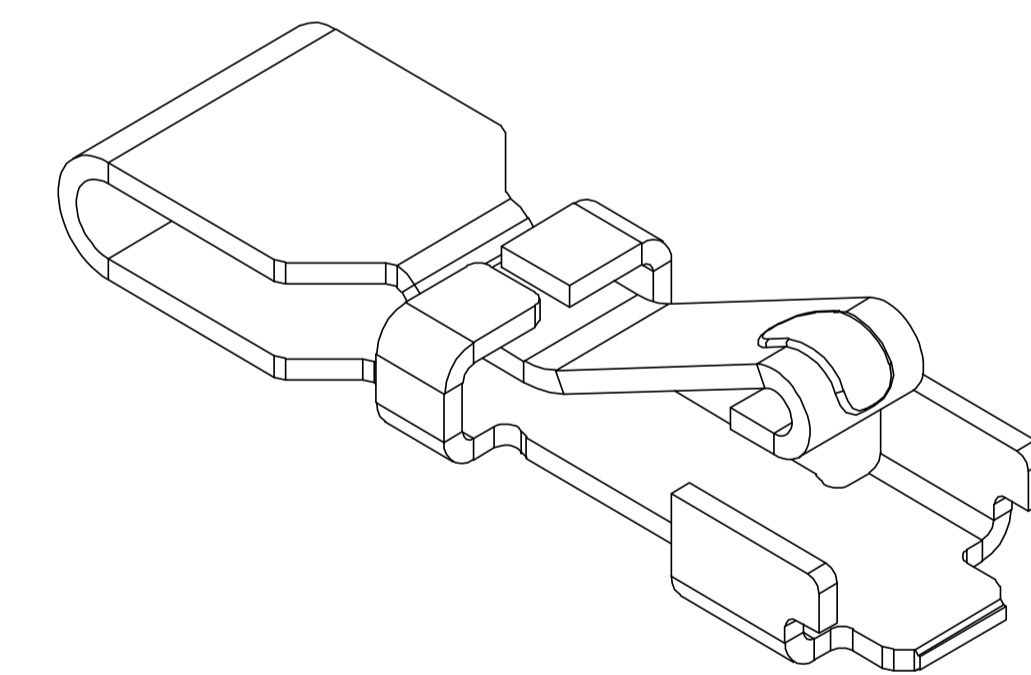
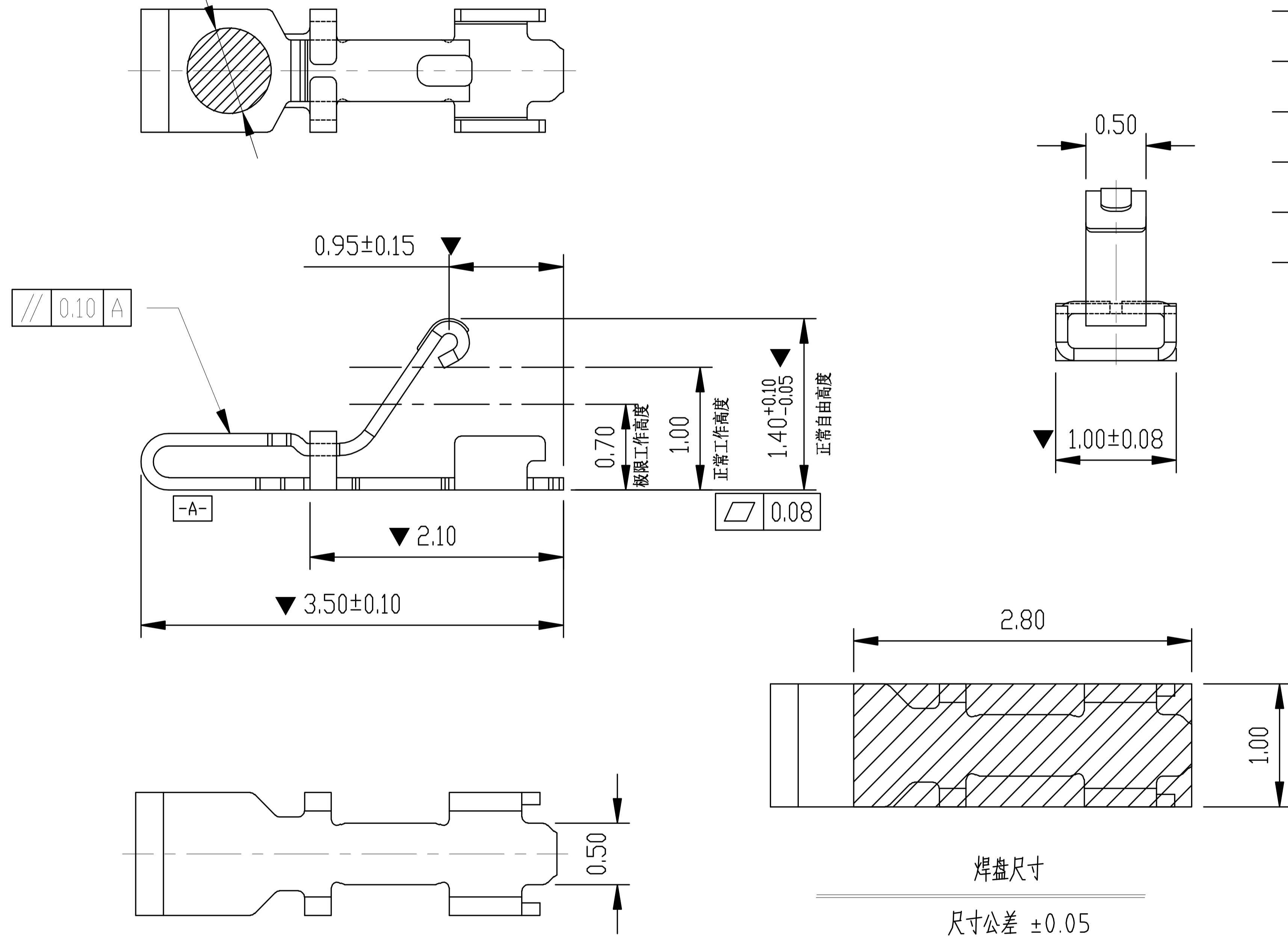

深圳市金航标电子有限公司
 WWW.BDS666.COM
 型号: KH-351014-TP
 0755-83044319

GENERAL TOLERANCE	
XX. ±0.50	
X. ±0.35	
.X ±0.25	
.XX ±0.15	

SCALE: 1:1	
UNIT: mm	
SIZE: A4	

DRAWN	DATE
CHECK	DATE
APPROVE	DATE

DWG. NO.	681-0036A-1
PARTS NO.(INTENDED USE)	JXH0036A1

TITLE **客户图**
 RF Antenna Spring, SMT,
 L3.50*W1.0*H1.4mm

REV. A
 SHEET 1/1