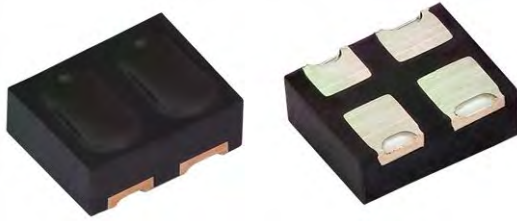


Reflective Optical Sensor With Transistor Output



DESCRIPTION

The VCNT2020 is a reflective sensor in a miniature SMD package. It has a compact construction where the emitting light source and the detector are arranged in the same plane. The operating infrared wavelength is 940 nm. The detector consists of a silicon phototransistor. The sensor analog output signal (photo current) is triggered by detection of reflected infrared light from a close by object.

The sensor has a built in daylight blocking filter, which greatly suppresses disturbing ambient light and therefore increases signal to noise ratio.

FEATURES

- Package type: SMD
- Detector type: phototransistor
- Dimensions (L x W x H in mm): 2.5 x 2 x 0.8
- Operating range within > 20 % relative collector current: 0.2 mm to 2.5 mm
- Emitter wavelength: 940 nm
- Moisture sensitivity level (MSL): 4
- Material categorization: for definitions of compliance please see www.vishay.com/doc?99912



RoHS
COMPLIANT
HALOGEN
FREE

APPLICATIONS

- Position sensor
- Optical switch
- Optical encoder (e.g. disc and tape drives for DVD and / or camera applications)
- Object detection (e.g. paper presence in printer and copy machines)

PRODUCT SUMMARY				
PART NUMBER	DISTANCE FOR MAXIMUM CTR _{rel} ⁽¹⁾ (mm)	DISTANCE RANGE FOR RELATIVE I _{out} > 20 % (mm)	TYPICAL OUTPUT CURRENT UNDER TEST ⁽²⁾ (mA)	DAYLIGHT BLOCKING FILTER INTEGRATED
VCNT2020	0.5	0.2 to 2.5	1.6	Yes

Notes

(1) CTR: current transfer ratio, I_{out}/I_{in}

(2) Conditions like in table basic characteristics/sensors

ORDERING INFORMATION			
ORDERING CODE	PACKAGING	VOLUME ⁽¹⁾	REMARKS
VCNT2020	Tape and reel	MOQ: 3000 pcs	Drypack, MSL 4

Note

(1) MOQ: minimum order quantity

ABSOLUTE MAXIMUM RATINGS (T _{amb} = 25 °C, unless otherwise specified)				
PARAMETER	TEST CONDITION	SYMBOL	VALUE	UNIT
INPUT (EMITTER)				
Reverse voltage		V _R	5	V
Forward current		I _F	100	mA
Forward surge current	t _p ≤ 100 μs	I _{FSM}	500	mA
OUTPUT (DETECTOR)				
Collector emitter breakdown voltage		V _{(BR)CEO}	20	V
Emitter collector voltage		V _{ECO}	7	V
Collector current		I _C	20	mA
SENSOR				
Total power dissipation	T _{amb} ≤ 25 °C	P _{tot}	170	mW
Ambient temperature range		T _{amb}	-25 to +85	°C
Storage temperature range		T _{stg}	-25 to +85	°C
Soldering temperature	In accordance with Fig. 11	T _{sd}	260	°C

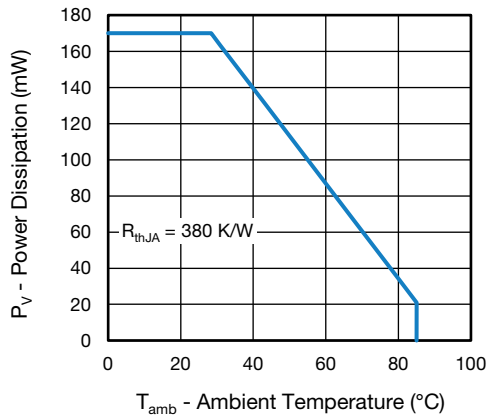
ABSOLUTE MAXIMUM RATINGS


Fig. 1 - Power Dissipation vs. Ambient Temperature

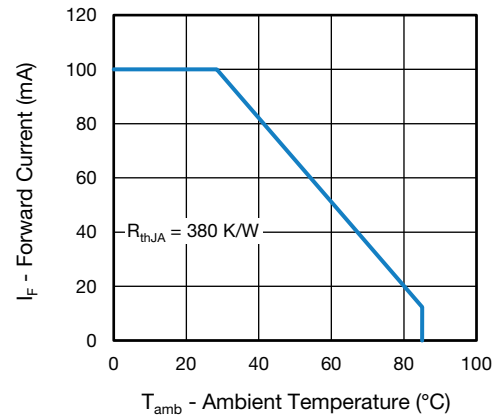


Fig. 2 - Forward Current vs. Ambient Temperature

BASIC CHARACTERISTICS (T _{amb} = 25 °C, unless otherwise specified)						
PARAMETER	TEST CONDITION	SYMBOL	MIN.	TYP.	MAX.	UNIT
INPUT (EMITTER)						
Forward voltage	I _F = 20 mA	V _F	-	1.25	1.4	V
	I _F = 100 mA		-	1.5	1.7	
Temperature coefficient of V _F	I _F = 20 mA	TKV _F	-	-1.0	-	mV/K
Peak wavelength	I _F = 100 mA	λ _P	-	940	-	nm
Reverse current	V _R = 5 V	I _R	-	-	10	μA
OUTPUT (DETECTOR)						
Collector emitter breakdown voltage	I _C = 0.1 mA, E = 0	V _{(BR)CEO}	20	-	-	V
Emitter collector voltage	I _E = 100 μA, E = 0	V _{ECO}	7	-	-	V
Collector emitter dark current	V _{CE} = 5 V, E = 0	I _{CEO}	-	1	100	nA
SENSOR						
Collector current	V _{CE} = 5 V, I _F = 20 mA, d = 1 mm	I _C	0.5	1.6	3.5	mA
Current transfer ratio	I _C /I _F , d = 1 mm, V _{CE} = 5 V	CTR	-	8	-	%
Rise time	I _C = 0.8 mA, V _{CE} = 5 V, R _L = 100 Ω	t _r	-	10	70	μs
Fall time	I _C = 0.8 mA, V _{CE} = 5 V, R _L = 100 Ω	t _f	-	15	70	μs

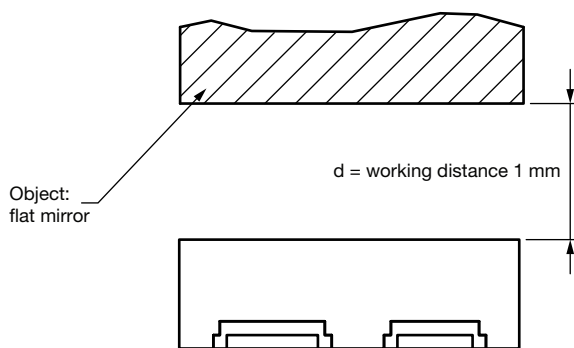


Fig. 3 - Test Circuit

BASIC CHARACTERISTICS ($T_{amb} = 25\text{ }^{\circ}\text{C}$, unless otherwise specified)

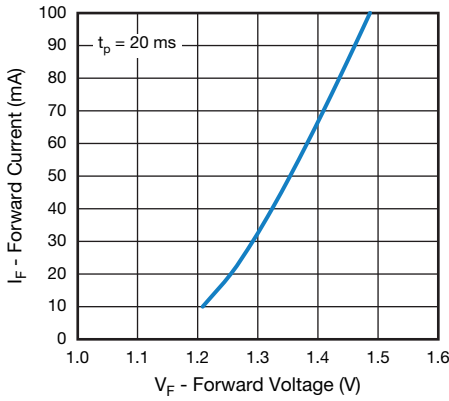


Fig. 4 - Forward Current vs. Forward Voltage

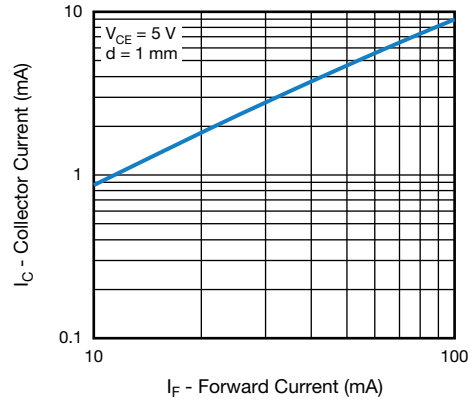


Fig. 7 - Collector Current vs. Forward Current

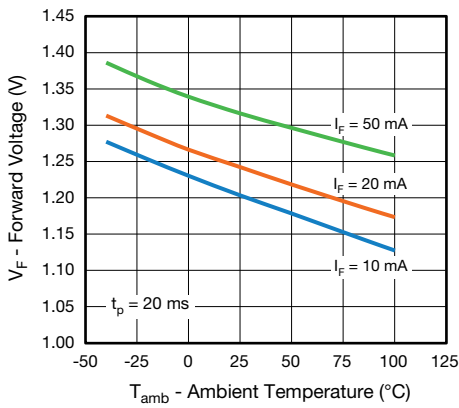


Fig. 5 - Forward Voltage vs. Ambient Temperature

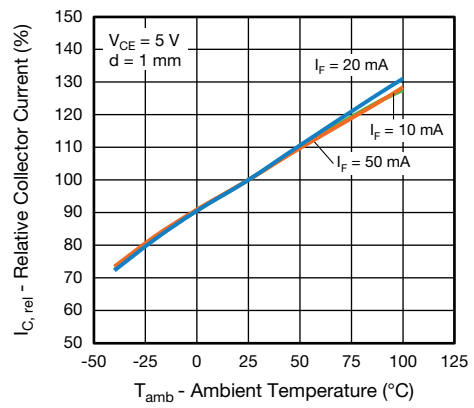


Fig. 8 - Relative Collector Current vs. Ambient Temperature

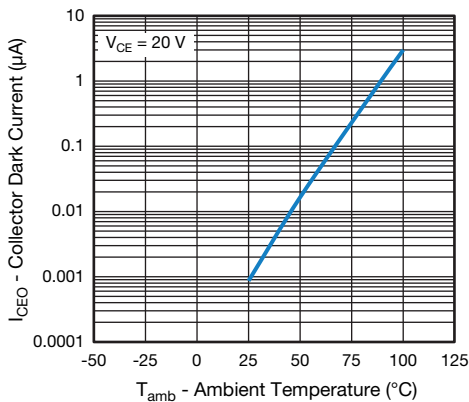


Fig. 6 - Collector Dark Current vs. Ambient Temperature

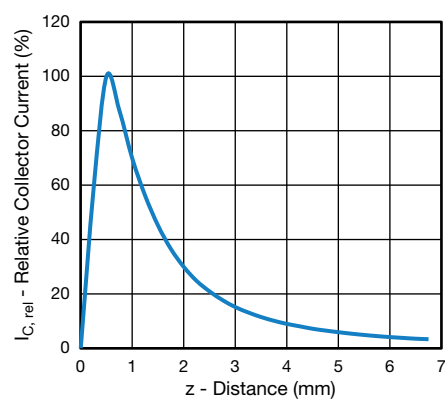


Fig. 9 - Relative Collector Current vs. Distance

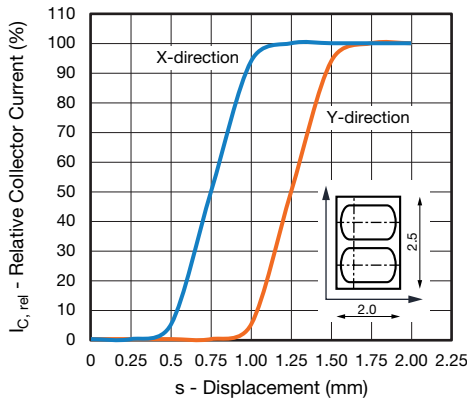


Fig. 10 - Relative Collector Current vs. Displacement

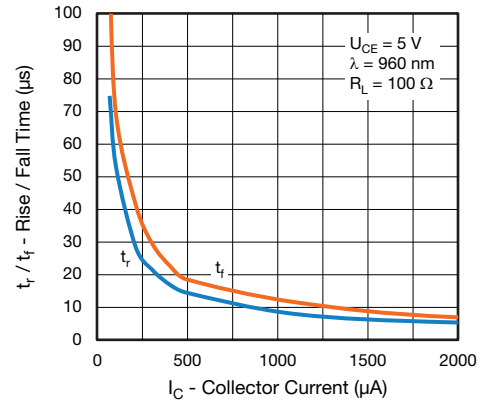


Fig. 11 - Rise / Fall Time vs. Collector Current

FLOOR LIFE

Time between soldering and removing from MBB must not exceed the time indicated in J-STD-020:

Moisture sensitivity: level 4

Floor life: 72 h

Conditions: $T_{amb} < 30\text{ }^{\circ}\text{C}$, RH < 60 %

DRYING

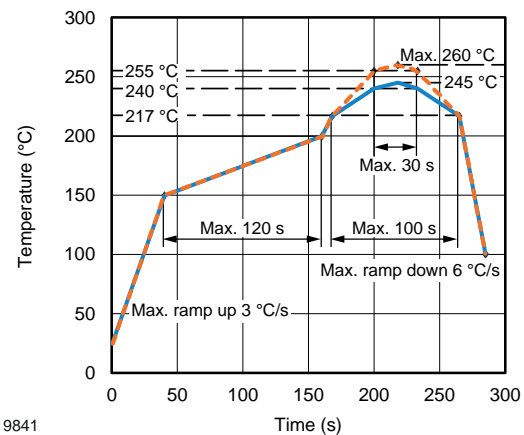
In case of moisture absorption devices should be baked before soldering. Conditions see J-STD-020 or recommended conditions:

192 h at 40 °C (+ 5 °C), RH < 5 %

or

96 h at 60 °C (+ 5 °C), RH < 5 %

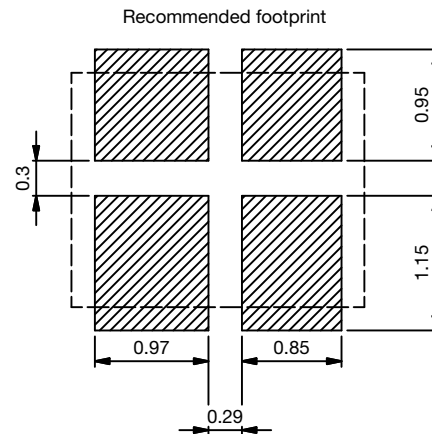
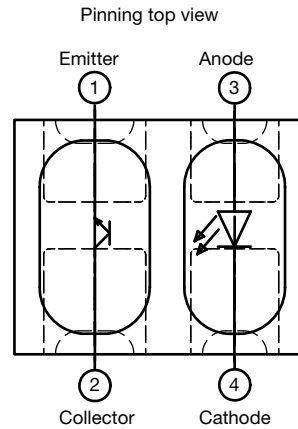
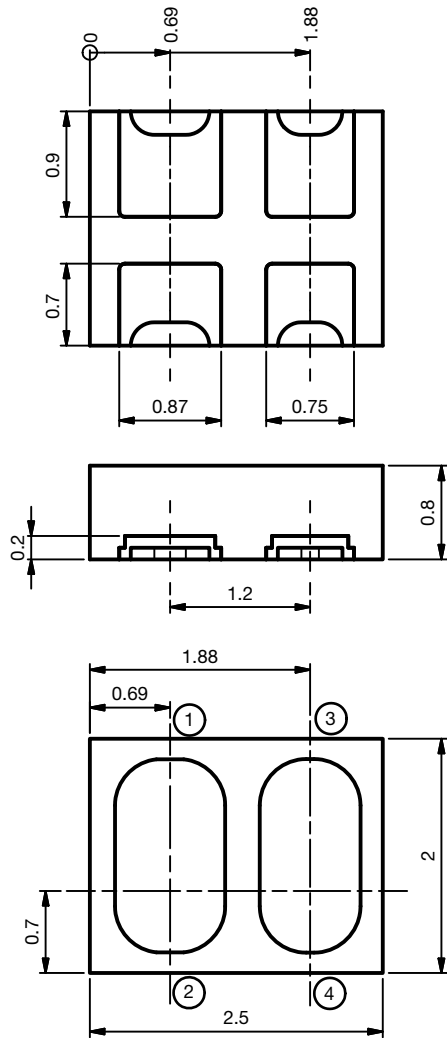
REFLOW SOLDER PROFILE



19841

Fig. 12 - Lead (Pb)-free Reflow Solder Profile According to J-STD-020

PACKAGE DIMENSIONS in millimeters



Drawing-No.: 6.550-5338.01-4
Issue: 1; 16.06.2016

Not indicated tolerances ± 0.1

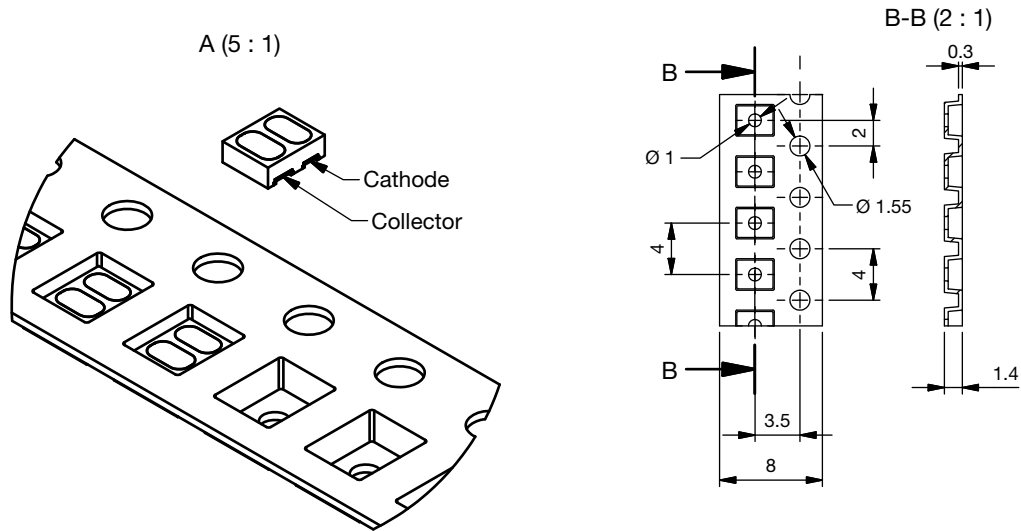
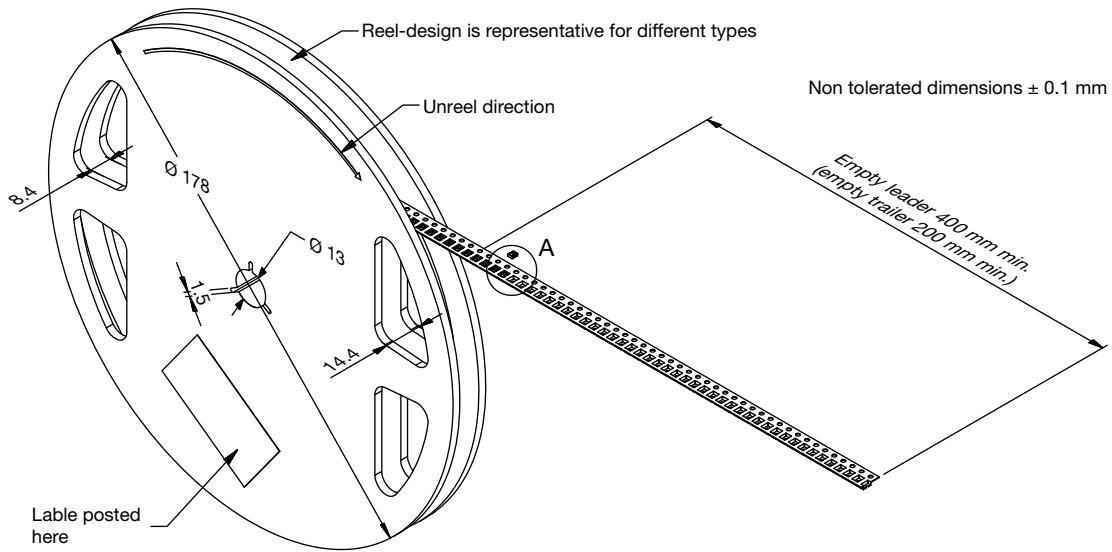


Technical drawings according to DIN specification



TAPE AND REEL DIMENSIONS in millimeters

3000 pcs/reel



Drawing refers to following Type: VCNT2020
 Drawing No.: 9.800-5132.01-4
 Issue: 1; 18.01.2018



Disclaimer

ALL PRODUCT, PRODUCT SPECIFICATIONS AND DATA ARE SUBJECT TO CHANGE WITHOUT NOTICE TO IMPROVE RELIABILITY, FUNCTION OR DESIGN OR OTHERWISE.

Vishay Intertechnology, Inc., its affiliates, agents, and employees, and all persons acting on its or their behalf (collectively, "Vishay"), disclaim any and all liability for any errors, inaccuracies or incompleteness contained in any datasheet or in any other disclosure relating to any product.

Vishay makes no warranty, representation or guarantee regarding the suitability of the products for any particular purpose or the continuing production of any product. To the maximum extent permitted by applicable law, Vishay disclaims (i) any and all liability arising out of the application or use of any product, (ii) any and all liability, including without limitation special, consequential or incidental damages, and (iii) any and all implied warranties, including warranties of fitness for particular purpose, non-infringement and merchantability.

Statements regarding the suitability of products for certain types of applications are based on Vishay's knowledge of typical requirements that are often placed on Vishay products in generic applications. Such statements are not binding statements about the suitability of products for a particular application. It is the customer's responsibility to validate that a particular product with the properties described in the product specification is suitable for use in a particular application. Parameters provided in datasheets and / or specifications may vary in different applications and performance may vary over time. All operating parameters, including typical parameters, must be validated for each customer application by the customer's technical experts. Product specifications do not expand or otherwise modify Vishay's terms and conditions of purchase, including but not limited to the warranty expressed therein.

Except as expressly indicated in writing, Vishay products are not designed for use in medical, life-saving, or life-sustaining applications or for any other application in which the failure of the Vishay product could result in personal injury or death. Customers using or selling Vishay products not expressly indicated for use in such applications do so at their own risk. Please contact authorized Vishay personnel to obtain written terms and conditions regarding products designed for such applications.

No license, express or implied, by estoppel or otherwise, to any intellectual property rights is granted by this document or by any conduct of Vishay. Product names and markings noted herein may be trademarks of their respective owners.