

Low Power Low Offset Voltage Dual Comparators

1. DESCRIPTION

The HT293 consists of two independent precision voltage comparators with an offset voltage specification as low as 2.0 mV max for two comparators which were designed specifically to operate from a single power supply over a wide range of voltages.

Application areas include limit comparators, simple analog to digital converters; pulse, square wave and time delay generators; wide range VCO; MOS clock timers; multi-vibrators and high voltage digital logic gates.

2. FEATURES

- Single or Split Supply Operation
- Low Input Bias Current
- Low Input Offset Current
- Input Common Mode Voltage Range to Gnd
- Low Output Saturation Voltage
- TTL and CMOS Compatible

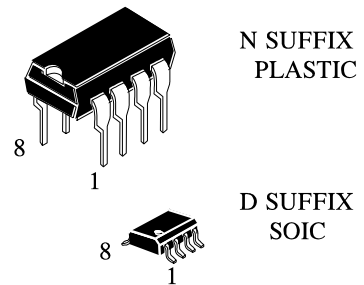

**ORDERING INFORMATION**  
 HT293N Plastic  
 HT293R SOIC  
 T<sub>A</sub> = -40° to 85° C for all packages.

LOGIC DIAGRAM

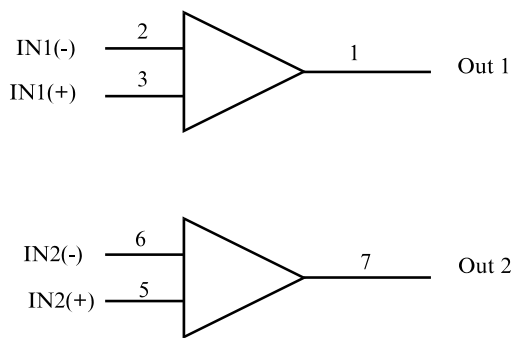

PIN 8 = V<sub>CC</sub>  
 PIN 4 = GND

PIN ASSIGNMENT

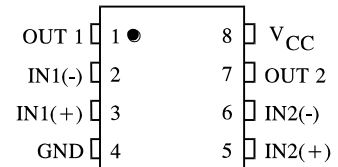

### 3. MAXIMUM RATINGS

Symbol	Parameter	Value	Unit
$V_{CC}$	Power Supply Voltages		
	Single Supply	36	V
	Split Supplies	$\pm 18$	
$V_{IDR}$	Input Differential Voltage Range	36	V
$V_{ICR}$	Input Common Mode Voltage Range (1)	$-0.3$ to $V_{CC}$	V
$I_{SC}$	Output Short Circuit to Ground	Continuous	
$I_{IN}$	Input Current, per pin (2)	50	mA
$T_J$	Junction Temperature		
	Plastic Packages	150	$^{\circ}\text{C}$
Tstg	Storage Temperature	$-65$ to $+150$	$^{\circ}\text{C}$
$T_L$	Lead Temperature, 1mm from Case for 10 Seconds	260	$^{\circ}\text{C}$
$P_D$	Power Dissipation @ $T_A=25^{\circ}\text{C}$		
	Plastic Package	570	$\mu\text{W}$
	Derate above $25^{\circ}\text{C}$	5.7	$\text{mW}/^{\circ}\text{C}$

\*Maximum Ratings are those values beyond which damage to the device may occur. Functional operation should be restricted to the Recommended Operating Conditions.

Notes:

1. Split Power Supplies.
2.  $V_{IN} < -0.3\text{V}$ . This input current will only exist when voltage at any of the input leads is driven negative.

### 4. RECOMMENDED OPERATING CONDITIONS

Symbol	Parameter	Min	Max	Unit
$V_{CC}$	DC Supply Voltage	$\pm 2.5$ or 5.0	$\pm 15$ or 30	V
$T_A$	Operating Temperature, All Package Types	-40	+85	$^{\circ}\text{C}$

This device contains protection circuitry to guard against damage due to high static voltages or electric fields. However, precautions must be taken to avoid applications of any voltage higher than maximum rated voltages to this high-impedance circuit. For proper operation,  $V_{IN}$  and  $V_{OUT}$  should be constrained to the range  $\text{GND} \leq (V_{IN} \text{ or } V_{OUT}) \leq V_{CC}$ .

Unused inputs must always be tied to an appropriate logic voltage level (e.g., either GND or  $V_{CC}$ ). Unused outputs must be left open.

**5. DC ELECTRICAL CHARACTERISTICS** ( $T_A=-40$  to  $+85^{\circ}\text{C}$ )

Symbol	Parameter	Test Conditions	Guaranteed Limit			Unit
			Min	Typ	Max	
$V_{IO}$	Input Offset Voltage	$V_0=1.4\text{V}$ $V_{CC}=5.0\text{-}30\text{V}; R_S \leq 100\Omega$ $V_{ICR}=0\text{V} - (V_{CC}-1.5)\text{V}$	-		9.0	mV
$I_{IB}$	Input Bias Current	$V_0=1.4\text{V}$ $V_{CC}=5.0\text{-}30\text{V}$ $V_{ICR}=0\text{V} - (V_{CC}-1.5)\text{V}$	-		400	nA
$I_{IO}$	Input Offset Current	$V_0=1.4\text{V}$ $V_{CC}=5.0\text{-}30\text{V}$ $V_{ICR}=0\text{V} - (V_{CC}-1.5)\text{V}$	-		$\pm 150$	nA
$V_{ICR}$	Input Common Mode Voltage Range	$V_{CC}=5.0\text{-}30\text{V}$	0		$V_{CC}-2.0$ V	V
$I_{CC}$	Supply Current	$R_L=\infty, V_{CC}=5.0$ $R_L=\infty, V_{CC}=30\text{V}$	-		1.0* 2.5*	mA
$A_{VOL}$	Voltage Gain	$V_{CC}=15\text{V}, R_L=15\text{K}\Omega$	-	200*	-	V/mV
$t_1$	Large Signal Response Time	$V_{IN}=\text{TTL Logic Swing}$ , $V_{ref}=1.4\text{V}, V_{CC}=5.0\text{V}$ , $R_L=5.1\text{K}\Omega, V_{RL}=5.0\text{V}$	-	300*	-	ns
$t_2$	Response Time (Note 6)	$V_{CC}=5.0\text{V}, R_L=5.1\text{K}\Omega$ , $V_{RL}=5.0\text{V}$	-	1.3*	-	$\mu\text{s}$
$I_{sink}$	Output Sink Current	$V_{I(-)}=1.0\text{V}, V_{I(+)}=0\text{V}$ , $V_0 \leq 1.5\text{V}, V_{CC}=5.0\text{V}$	6.0*	-	-	mA
$V_{sat}$	Saturation Voltage	$V_{I(-)}=1.0\text{V}, V_{I(+)}=0\text{V}$ , $I_{sink} \leq 4.0\text{mA}, V_{CC}=5.0\text{V}$	-	-	700	mV
$I_{OL}$	Output Leakage Current	$V_{I(+)}=1.0\text{V}, V_{I(-)}=0\text{V}$ , $V_0=5.0\text{V}$ $V_0=30\text{V}$		0.1*	1000	nA
$V_{IDR}$	Differential Input Voltage Range	All $V_{IN} \geq \text{GND}$ or V-Supply (if used)			$V_{CC}$	V

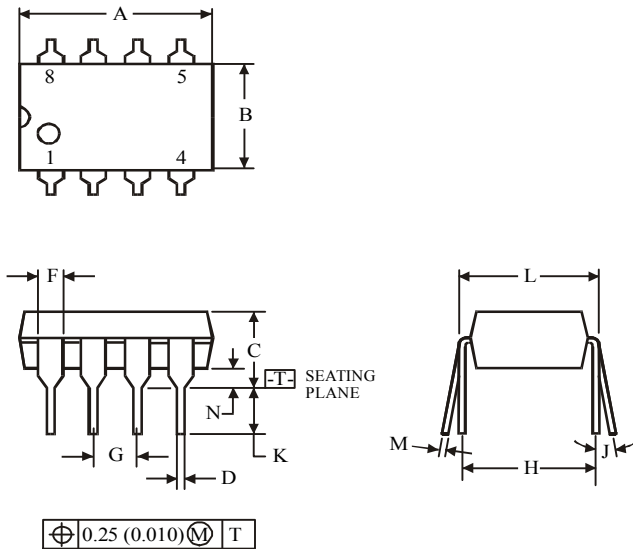
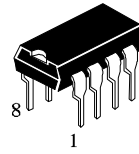
**(DIP8)**

Symbol	Dimension, mm	
	MIN	MAX
A	8.51	10.16
B	6.1	7.11
C		5.33
D	0.36	0.56
F	1.14	1.78
G	2.54	
H	7.62	
J	0°	10°
K	2.92	3.81
L	7.62	8.26
M	0.2	0.36
N	0.38	

**NOTES:**

- Dimensions "A", "B" do not include mold flash or protrusions.  
Maximum mold flash or protrusions 0.25 mm (0.010) per side.

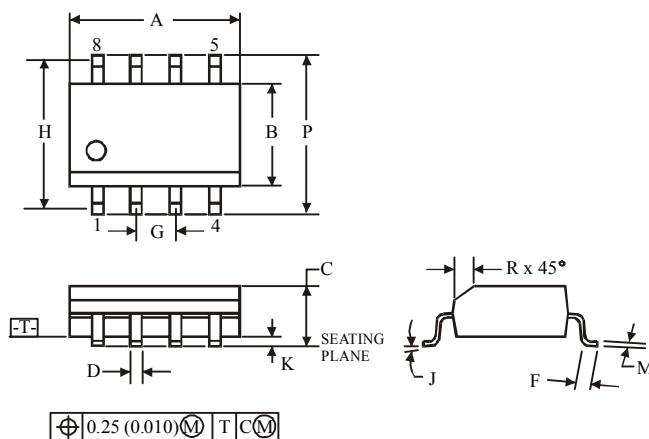
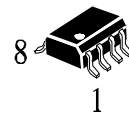
**(SOP8)**

Symbol	Dimension, mm	
	MIN	MAX
A	4.8	5
B	3.8	4
C	1.35	1.75
D	0.33	0.51
F	0.4	1.27
G	1.27	
H	5.72	
J	0°	8°
K	0.1	0.25
M	0.19	0.25
P	5.8	6.2
R	0.25	0.5

**NOTES:**

- Dimensions A and B do not include mold flash or protrusion.
- Maximum mold flash or protrusion 0.15 mm (0.006) per side for A; for B - 0.25 mm (0.010) per side.