

8CH Darlington Sink Driver

The HT62083A&HT62084A are high-voltage, high-current darlington drivers comprised of eight NPN darlington pairs.

All units feature integral clamp diodes for switching inductive loads.

Application include relay, hammer, lamp and display (LED) drivers.

Features

- Output current (single output)
500mA (Max)
- Output clamp diodes
- Inputs compatible with various types of logic

TYPE	INPUT BASE RESISTOR	DESIGNATION
HT62083AN/ARW	2.7k Ω	TTL, 5V CMOS
HT62084AN/ARW	10.5k Ω	6~15V PMOS, CMOS

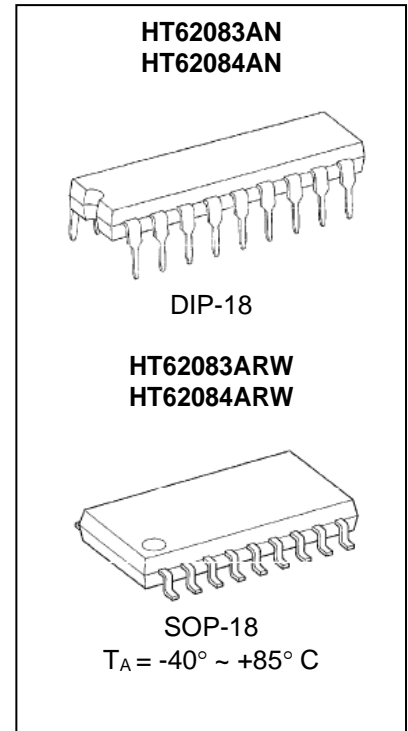

Pin Configuration (top view)

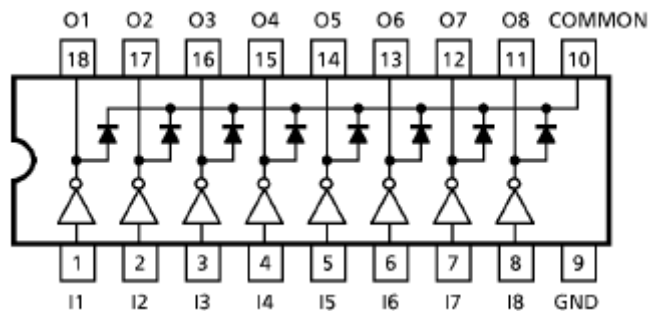

Block Schematics

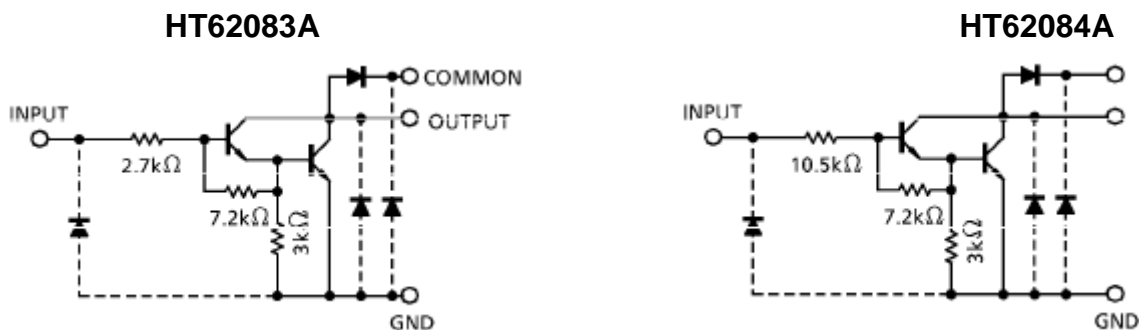

Note: The input and output parasitic diodes cannot be used as clamp diodes.

Maximum Ratings

Ta =25°C

Parameter	Symbol	Limit Values		Unit	
		min.	max.		
Output Sustaining Voltage	$V_{CE(SUS)}$	-0.5	50	V	
Output Current	I_{OUT}	500		mA/ch	
Input Voltage	V_{IN}	-0.5	30	V	
Clamp Diode Reverse Voltage	V_R	50		V	
Clamp Diode Forward Current	I_F	500		mA	
Power Dissipation	HT62083AN	P_D		1.47	W
	HT62083ADW			0.96	
Operating Temperature	T_{opr}	-40	85	°C	
Storage Temperature	T_{stg}	-55	150	°C	

* Stresses beyond those listed under “absolute maximum ratings” may cause permanent damage to the device. These are stress ratings only and functional operation of the device at these or any other conditions beyond those indicated under “recommended operating conditions” is not implied. Exposure to absolute-maximum-rated conditions for extended periods may affect device reliability.

Recommended Operating Conditions

(Ta=-40~85°C)

Parameter	Symbol	Test Condition	Limit Value			Unit	
			Min	Typ	Max		
Output Sustaining Voltage	$V_{CE(SUS)}$		0	-	50	V	
Output Current	N	I_{OUT}	$T_{pw}=25ms, Duty=10%, 8 Circuits$	0	-	347	mA/ch
			$T_{pw}=25ms, Duty=50%, 8 Circuits$	0	-	123	
	DW	$T_{pw}=25ms, Duty=10%, 8 Circuits$	0	-	268		
		$T_{pw}=25ms, Duty=50%, 8 Circuits$	0	-	90		
Input Voltage	V_{IN}		0	-	30	V	
Input Voltage (Output On)	HT62083A	$V_{IN(ON)}$		3.5	-	30	V
	HT62084A			8	-	30	
Clamp Diode Reverse Voltage	V_R		-	-	50	V	
Clamp Diode Forward Current	I_F		-	-	400	mA	
Power Dissipation	N	P_D		-	-	0.52	W
	DW			-	-	0.4	



Electrical Characteristics

Ta = 25°C

Parameter		Symbol	Test Circuit	Test Condition	Limit Values			Unit
					Min	Typ	Max	
Output Leakage Current	HT62083A	I _{CEX}	1	V _{CE} =50V, Ta=25°C	-	-	50	uA
				V _{CE} =50V, Ta=85°C	-	-	100	
	HT62084A			V _{CE} =50V, V _{IN} =1V	-	-	500	
Collector-Emitter Saturation Voltage		V _{CE(sat)}	2	I _{OUT} =350mA, I _{IN} =500um	-	1.3	1.6	V
				I _{OUT} =200mA, I _{IN} =350um	-	1.1	1.3	
				I _{OUT} =100mA, I _{IN} =250um	-	0.9	1.1	
Input Current	HT62083A	I _{IN(ON)}	2	V _{IN} =3.85V	-	0.93	1.35	mA
	HT62084A			V _{IN} =5V	-	0.35	0.5	
				V _{IN} =12V	-	1.0	1.45	
Input Voltage (Output On)	HT62083A	V _{IN(ON)}	5	V _{CE} =2V, I _{OUT} =200mA	-	-	2.4	V
				V _{CE} =2V, I _{OUT} =250mA	-	-	2.7	
				V _{CE} =2V, I _{OUT} =300mA	-	-	3.0	
	HT62084A			V _{CE} =2V, I _{OUT} =125mA	-	-	5.0	
	V _{CE} =2V, I _{OUT} =200mA			-	-	6.0		
	V _{CE} =2V, I _{OUT} =275mA			-	-	7.0		
	V _{CE} =2V, I _{OUT} =350mA			-	-	8.0		
DC Current Transfer Ratio		h _{FE}	2	V _{CE} =2V, I _{OUT} =350mA	1000	-	-	
Clamp Diode Reverse Current		I _R	6	Ta=25°C (Note)	-	-	50	uA
				Ta=85°C (Note)	-	-	100	
Clamp Diode Forward Voltage		V _F	7	I _F =350mA	-	-	2.0	V
Input Capacitance		C _{IN}	-		-	-	15	pF
Turn-On Delay		t _{ON}	8	R _L =125Ω, V _{OUT} =50V	-	0.1	-	us
Turn-Off Delay		t _{OFF}	8	R _L =125Ω, V _{OUT} =50V	-	0.21	-	us

Note : V_R=V_RMAX

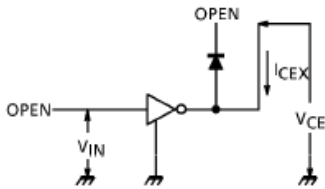
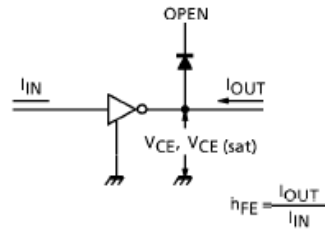
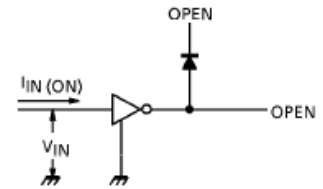
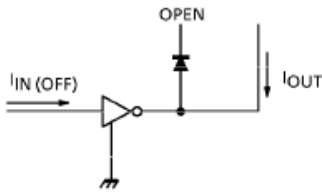
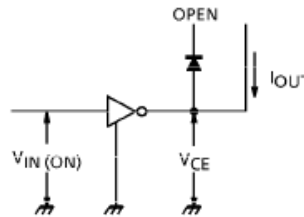
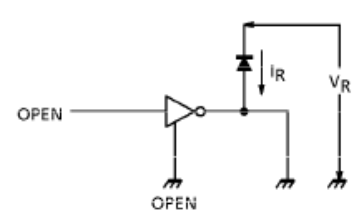
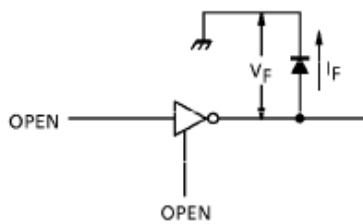
Test Circuit
1. I_{CEX}

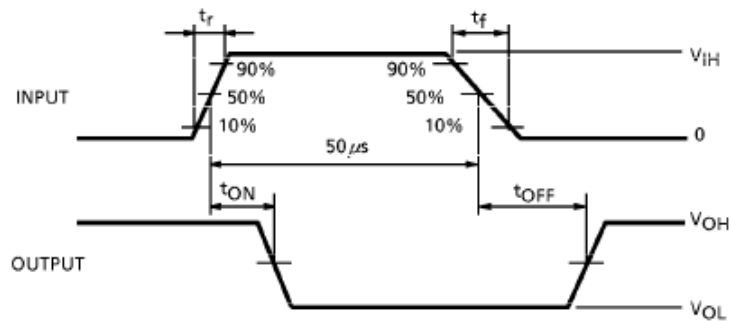
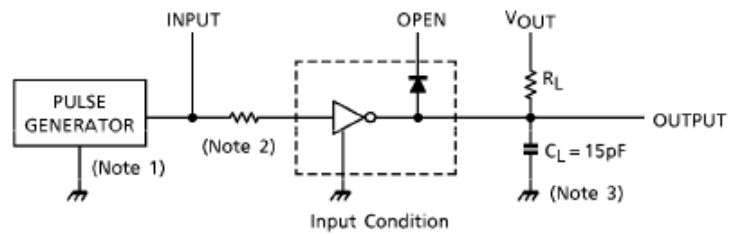
2. $V_{CE(sat)}$, h_{FE}

3. $I_{IN(ON)}$

4. $I_{IN(OFF)}$

5. $V_{IN(ON)}$

6. I_R

7. V_F

8. t_{ON} , t_{OFF}

Note 1 : Pulse Width 50us, Duty Cycle 10%
 Output Impedance 50Ω, $t_r \leq 5\text{ns}$, $t_f \leq 10\text{ns}$

Note 2 : See below.

Input Condition

Type number	R1	V_{IH}
HT62083A	0Ω	3V
HT62084A	0Ω	8V

Note 3 : C_L includes probe and jig capacitance

Precautions for Using

Utmost care is necessary in the design of output line, COMMON and GND line since IC may be destroyed due to short-circuit between outputs, air contaminaton fault, or fault by improper grounding.



HT62083AN

IIN vs VIN

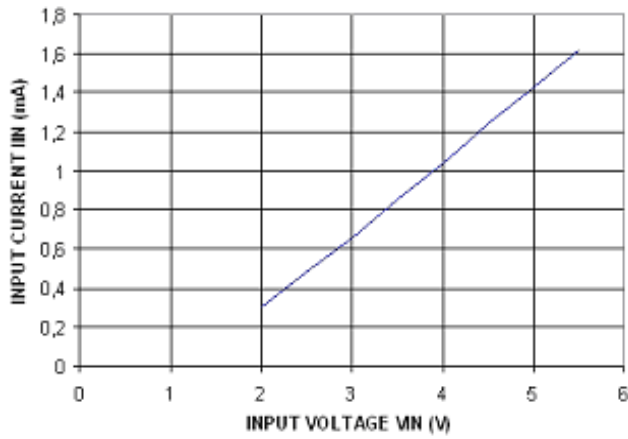

HT62084A

IIN vs VIN

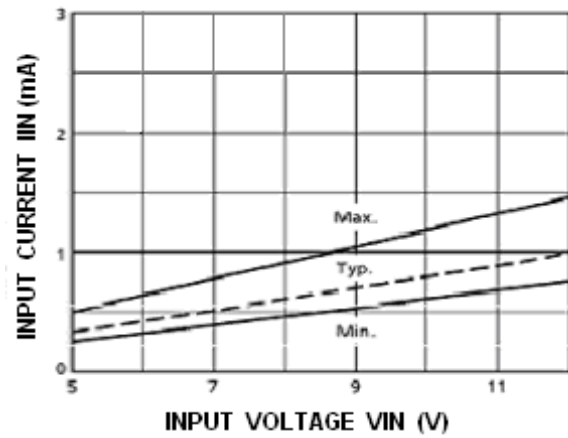

IOUT vs DUTY CYCLE

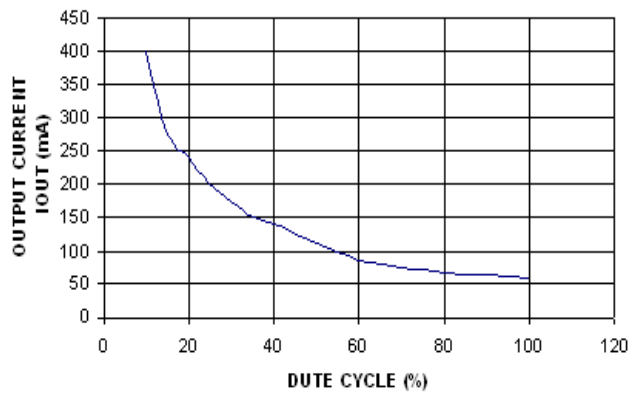

IOUT vs VCE (sat)

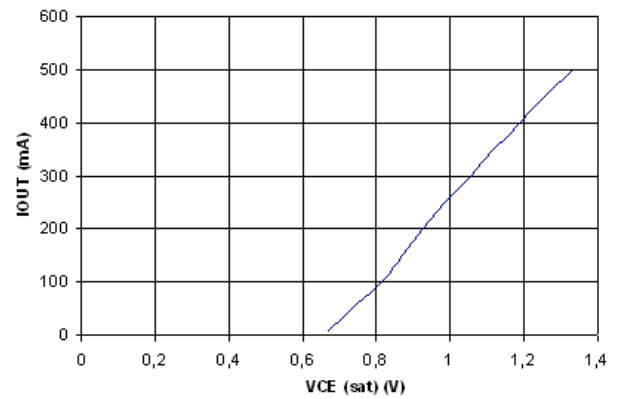

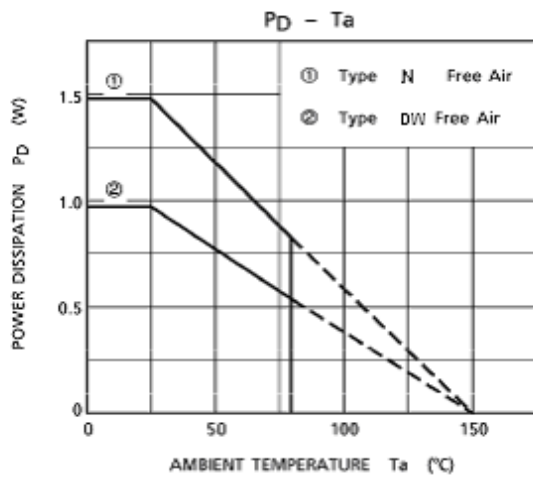
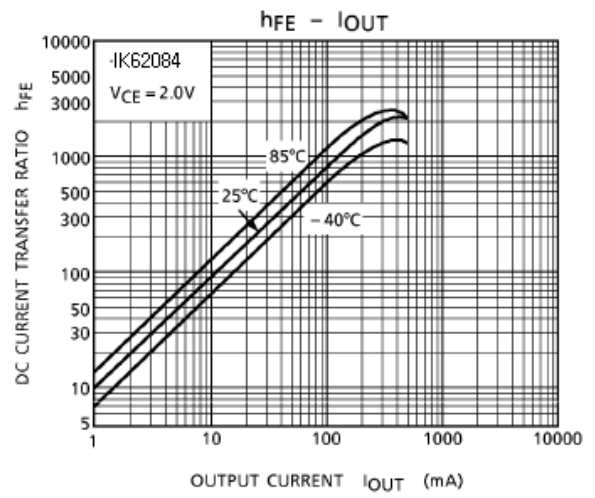
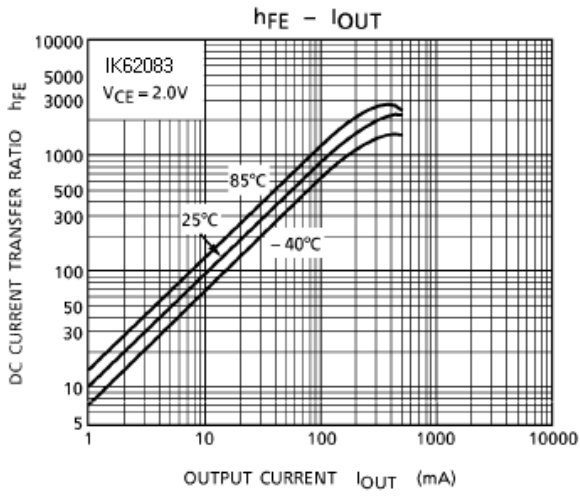



Package Dimensions

DIP-18

Unit: mm

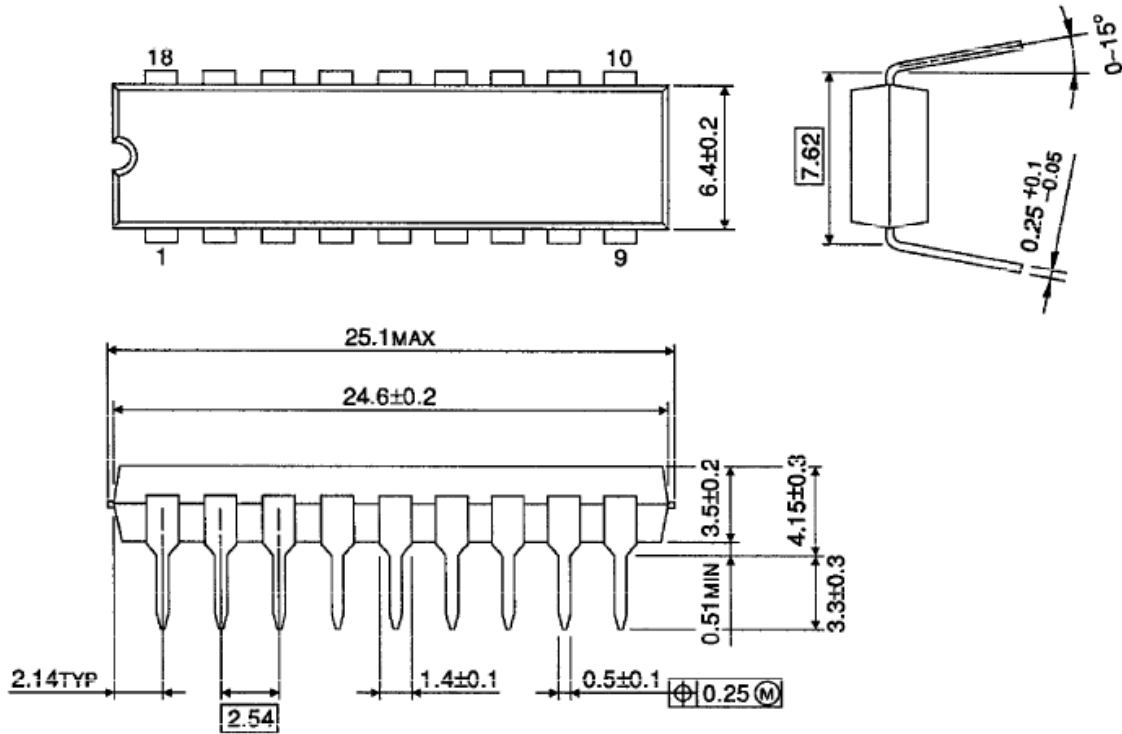

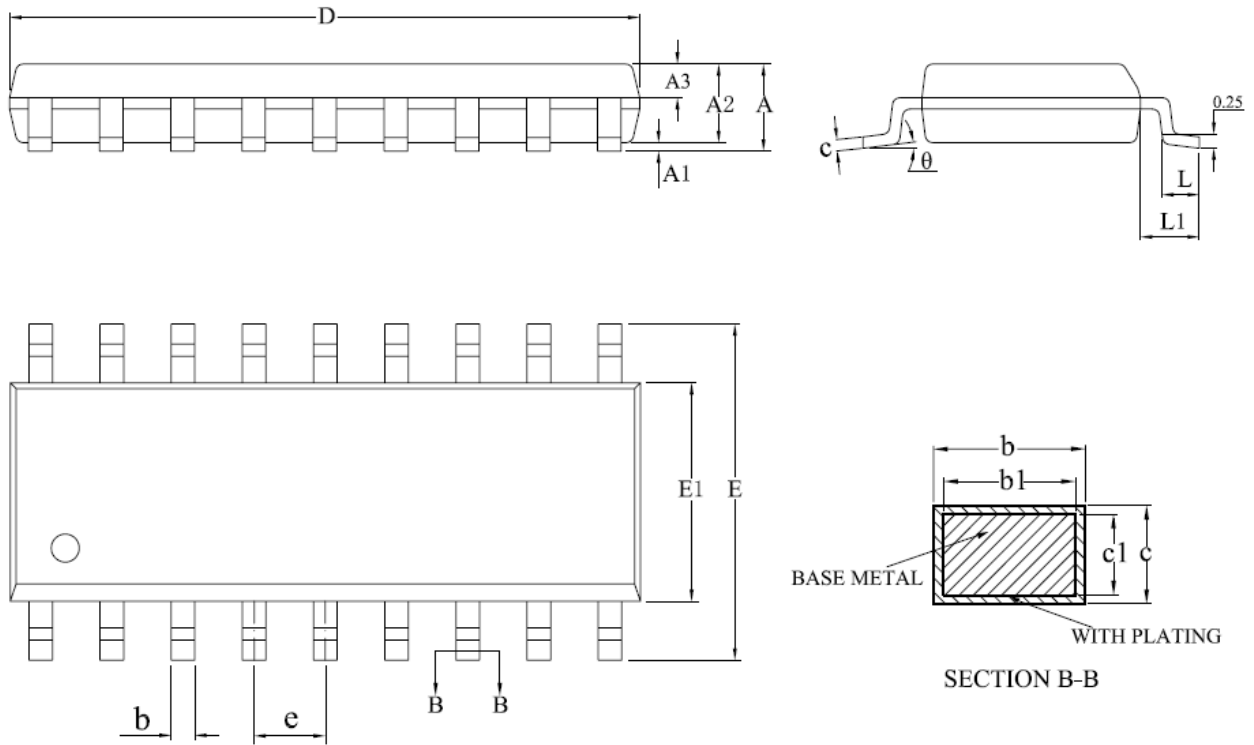
SOP-18

SYMBOL	MILLIMETER		
	MIN	NOM	MAX
A	—	—	2.70
A1	0.10	—	0.28
A2	2.25	2.30	2.35
A3	0.97	1.02	1.07
b	0.35	—	0.44
b1	0.34	0.37	0.39
c	0.26	—	0.31
c1	0.24	0.25	0.26
D	11.25	11.45	11.65
E	10.10	10.30	10.50
E1	7.30	7.50	7.70
e	1.27BSC		
L	0.70	—	1.00
L1	1.40BSC		
θ	0	—	8°
L/P载体尺寸 (mil)	140*160		