

Compact Video Driver Series for DSCs and Portable Devices



Compact, Low Current Consumption Single Output Video Drivers

BH76106HFV, BH76109HFV, BH76112HFV, BH76206HFV

No. 15064EBT03

●Description

This video amplifier with built-in LPF uses a full output swing type output stage to make low voltage operation at $V_{CC} = 2.6V$ possible.

In addition to advantages such as a tiny package and low power consumption, bands of the built-in LPF provide for 4.5 MHz products for DSC and other portable equipment and 6 MHz products for equipment such as DVD. Moreover, since it also can be used at $V_{CC} = 5V$, it is suited not only to portable equipment but also to equipment for stationary use.

●Features

- 1) Wide operating voltage range: $V_{CC} = 2.6V \sim 5.5V$
- 2) Built-in 8th order LPF
- 3) Built-in sync-tip clamp circuit
- 4) Compact HVSO6 package (3.0 mm × 1.6 mm × 0.75 mm)
- 5) Built-in standby function Standby current: 0 μA (typ.)
- 6) Selectable gain 6dB (BH76106HFV, BH76206HFV), 9dB (BH76109HFV), 12dB (BH76112HFV)
- 7) Selectable filter characteristics $f = 4.5MHz$ (BH761xxHFV), $f = 6.0MHz$ (BH76206HFV)

●Applications

Mobile phone, DSC, DVC, DVD, and other

●Line up matrix

Product Name	Amplifier Gain (dB)	LPF Frequency (MHz)
BH76106HFV	6	4.5
BH76109HFV	9	4.5
BH76112HFV	12	4.5
BH76206HFV	6	6.0

●Absolute Maximum Ratings

Parameter	Symbol	Rating	Unit
Power Supply Voltage	V_{CC}	7	V
Power Dissipation	P_d	410 *	mW
Operating Temperature Range	T_{opr}	-40~+85	°C
Storage Temperature Range	T_{stg}	-55~+125	°C

* When mounted on a 70 mm × 70 mm × 1.6 mm ROHM standard board, reduce by 4.1mW/°C above $T_a = +25^\circ C$

●Operating Range

Parameter	Symbol	Min.	Typ.	Max.	Unit
Power Supply Voltage	V_{CC}	2.6	3.0	5.5	V

* This product is not designed for protection against radio active rays.

●Electrical Characteristics (Unless otherwise noted, Typ.: Ta = 25 °C, VCC = 3.0 V)

Parameter	Symbol	Typical Values				Unit	Measurement Conditions
		BH76106HFV	BH76109HFV	BH76112HFV	BH76206HFV		
Circuit Current 1	Icc1	7			8	mA	With no signal
Circuit Current 2	Icc2	0.0				μA	In standby
Voltage Gain	Gv	6.0	9.0	12.0	6.0	dB	f=100kHz, Vin =1Vpp
Maximum Output Level	Vomv	2.6				Vpp	f=4.5MHz/100kHz(BH761xxHFV) f=6MHz/100kHz(BH76206HFV)
Frequency Characteristic 1	Gf1	0.1			-0.3	dB	f=4.5MHz/100kHz(BH761xxHFV) f=6MHz/100kHz(BH76206HFV)
Frequency Characteristic 2	Gf2	-4.0				dB	f=8.2MHz/100kHz(BH761xxHFV) f=12MHz/100kHz(BH76206HFV)
Frequency Characteristic 3	Gf3	-45.0			-40.0	dB	f=19MHz/100kHz(BH761xxHFV) f=27MHz/100kHz(BH76206HFV)
Y Channel output S/N	SNY	-67.0				dB	100kHz~500kHz band 75 Ω termination 100% white video signal
C Channel output S/N (AM)	SNCA	-77.0				dB	100kHz~500kHz band 75 Ω termination 100% chroma video signal
C Channel output S/N (PM)	SNCP	-65.0				dB	100kHz~500kHz band 75 Ω termination 100% chroma video signal
Differential Gain	DG	0.7			0.8	%	VIN = 1.0 Vp-p Standard stair-step signal
Differential Phase	DP	0.7			0.8	deg	VIN = 1.0 Vp-p Standard stair-step signal
Standby Switching Voltage High Level	VthH	1.2~Vcc				V	Standby OFF
Standby Switching Voltage Low Level	VthL	0~0.45				V	Standby ON
Standby Switch Input Current High Level	IthH	45			66	μA	Applying 3.0 V to Pin 6

●Control pin settings

Parameter	State	Function
Standby (Pin 6)	H	Active
	L	Standby
	OPEN	Standby

●Block Diagram

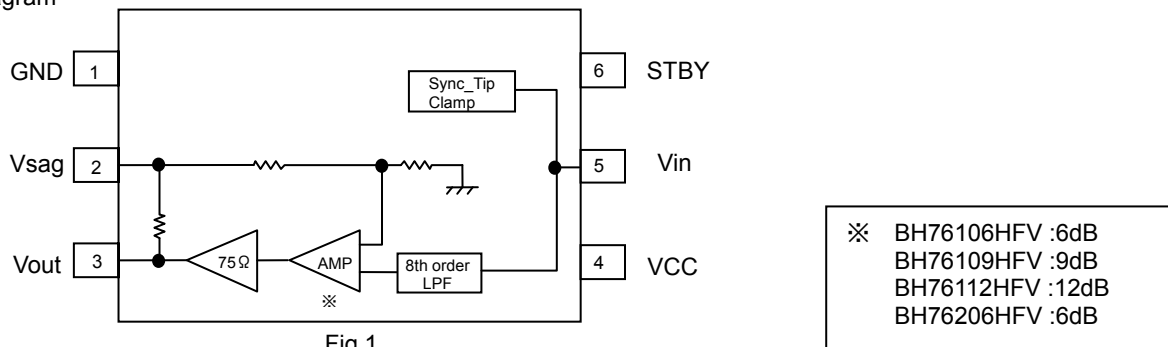
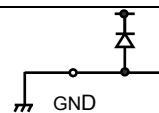
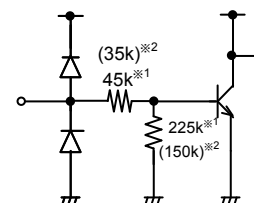
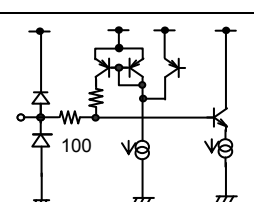
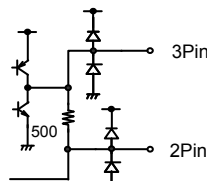

Fig.1

●Pin Descriptions

(Typical voltage is that when Vcc = 3.0 V, Ta = 25 °C)

Pin No.	Pin Name	IN	OUT	Typical voltage	Equivalent Circuit	Function
4	Vcc	-	-	3.0V		Power supply pin

Pin No.	Pin Name	IN	OUT	Typical voltage	Equivalent Circuit	Function
1	GND	-	-	0V		GND pin
6	Stnby	○	-	-		Standby pin HIGH: Active LOW: Standby ※1 BH76106HFV BH76109HFV BH76112HFV ※2 BH76206HFV
5	Vin	○	-	1.4V		Video signal input pin This is a sync-tip clamp format video signal input pin. For the coupling capacitor, 0.1 μF is recommended.
2 3	Vsag Vout	- ○	○ -	0.2V		Video signal output pin Video signal SAG correction pin

※The values show above (Voltage and resistance values) are reference values used for description, and are not guaranteed.

●Cautions on Use

- (1) Numeric values and data that are cited are representative design values and their values are not guaranteed.
- (2) Although we are confident recommending the application circuit example, carefully check the characteristics further in conjunction with its use. If using it after modifying externally attached component constants, try to determine adequate margins by including not just static characteristics but also transient characteristics to take into account variations in externally attached components and the ROHM LSI.
- (3) Absolute maximum ratings
If absolute maximum ratings such as applied voltage and operating temperature range are exceeded, the IC may be damaged. Do not apply voltages or temperatures that exceed the absolute maximum ratings. If you are considering circumstances in which an absolute maximum rating would be exceeded, implement physical safety measures such as fuses and investigate ways of not applying conditions exceeding absolute maximum ratings to the LSI.
- (4) GND potential
Even if the voltage of the GND pin is left in an operating state, make it the minimum voltage. Actually confirm that the voltage of each pin does not become a lower voltage than the GND pin, including for transient phenomena.
- (5) Thermal design
Perform thermal design in which there are adequate margins by taking into account the allowable dissipation under conditions of actual use.
- (6) Shorts between pins and mounting errors
When mounting the LSI on a board, be careful of the direction of the LSI and of misalignment. If mounted badly and current is passed through it, the LSI may be damaged. The LSI also may be damaged if shorted by a foreign substance getting in between LSI pins, between a pin and the power supply, or between a pin and GND.
- (7) Operation in a strong electromagnetic field
Since the LSI could malfunction if used in a strong electromagnetic field, evaluate this carefully.
- (8) Input termination resistor
Since there is a risk of oscillation at low temperatures (approximately -60 °C) if the termination resistor of the input pin is made high impedance, set it to no more than 700 Ω.

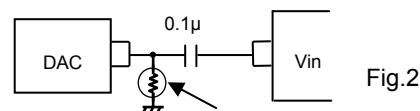

If the termination resistor of the input pin is greater than 700 Ω, connect it as shown in the figure below.

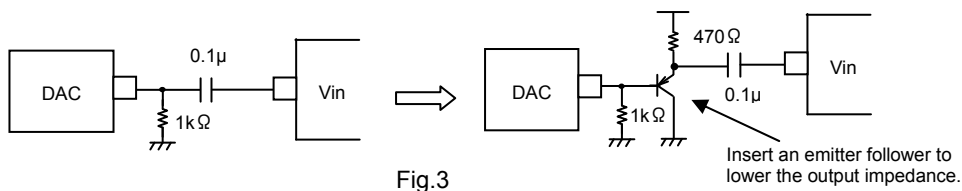

(9) Standby pin

When the standby pin is open, the LSI is in a standby state.

Since adding a voltage greater than V_{CC} at the standby pin turns a protective diode ON, make this at most $V_{CC}+0.2V$ (no greater than $V_{CC}+V_F$). (See Fig. 4) Applying a voltage to the standby pin when the voltage V_{CC} is not being applied also turns the protective diode ON, so do not apply a voltage.

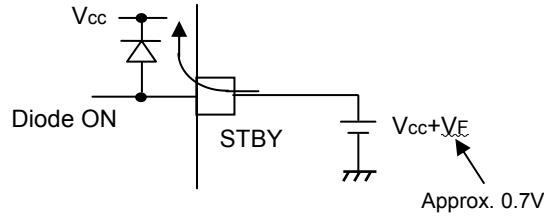

Fig.4

Responsiveness of Standby Control

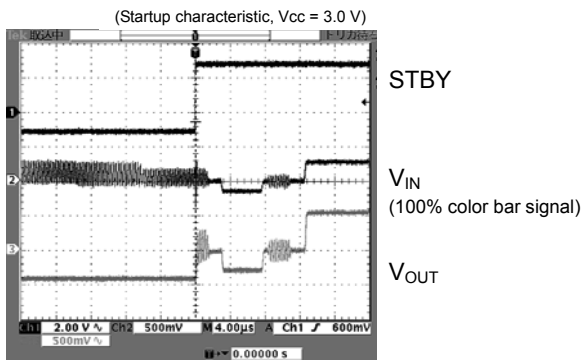

Fig.5 Standby Response Characteristic

※In relation to IC startup, this is practically 0 μ s.
Noise also does not occur when toggling the switch.

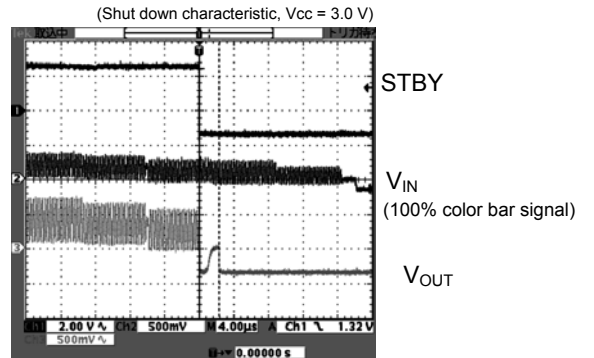

Fig.6 Standby Response Characteristic

※In relation to IC shutdown, this is after approximately 2 μ s.

(10) Input coupling capacitor

Making the input coupling capacitor a value less than 0.1 μ F (the recommended value) increases SAG. Determine the capacitance of the input capacitor used after taking into consideration the relationship of SAG to input coupling capacitor.

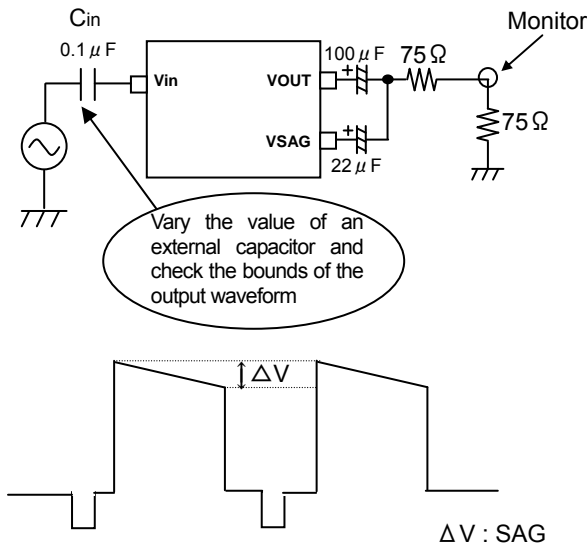
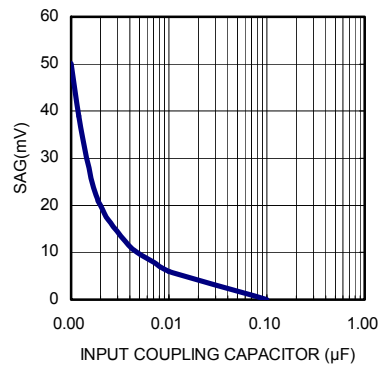

Fig.7



Relationship of SAG to Input Coupling Capacitor

Fig.8

Moreover, if you make the input coupling capacitor a value greater than 0.1 μ F (the recommended value), it may take time for the output waveform to stabilize. Decide the value of the coupling capacitor used by referring to the results shown in Fig. 10.

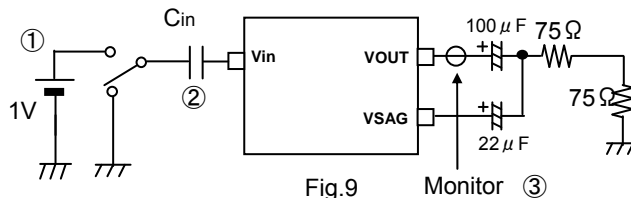
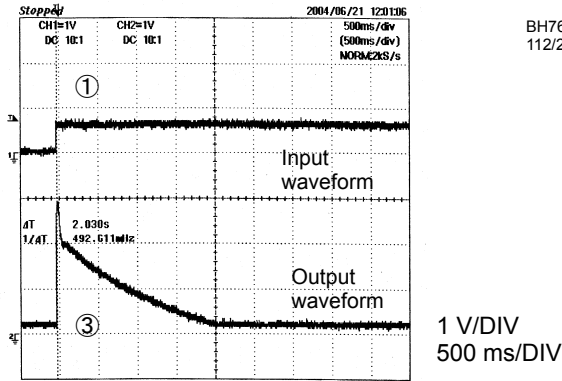

Fig.9



BH76106/109/
112/206HFV

1. When input coupling capacitor (②) is 0.1 μF
Time until output voltage stabilizes (③): 214 ms
2. When input coupling capacitor (②) is 0.56 μF
Time until output voltage stabilizes (③): 1.11 s
3. When input coupling capacitor (②) is 1 μF
Time until output voltage stabilizes (③): 2.03 s

Fig10 Relationship of Output Voltage to Input Voltage
(For BH76106HFV $C_{in}=1\mu\text{F}$)

(11) SAG correction

In order to make the SAG of the video signal as small as possible, we recommend the values of the application circuit diagram for output coupling capacitor capacitance.

If reducing capacitance due to the demands of miniaturization or the like, check the SAG characteristic for an alternating black and white bounce signal *1, Hbar signal *2, or other signal for which a SAG effect readily occurs and use a capacitance that satisfies the demands of the set being used.

As a reference, try the combinations shown below when reducing capacitance. As the capacitance of the V_{out} capacitor is made smaller, SAG becomes greater.

*1,*2: TG-7 U705 unit or other

V_{sag} Capacitor (C1)	33 μF	33 μF	33 μF
V_{out} Capacitor (C2)	68 μF	47 μF	33 μF

(12) Using after removing output coupling capacitor

An application circuit that is an example of use after removing the output coupling capacitor is shown in the figure below.

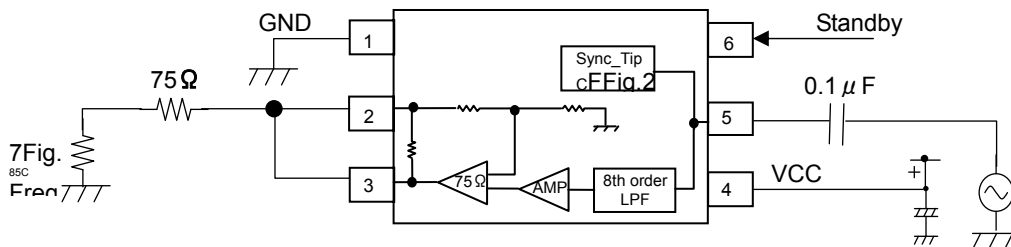

Fig.11

By eliminating the output coupling capacitor, not only can you reduce board space and product cost, but improvement of the SAG characteristic also can be realized due to the fact that the low-band frequency characteristic is improved. However, since direct current will flow in a set connected on the opposite side due to eliminating the output coupling capacitor, pay close attention to the specifications of what is connected in conjunction with using it.

Moreover, characteristics such as circuit current, differential gain, and differential phase differ as shown below.

Parameter	With Output Coupling Capacitor	Without Output Coupling Capacitor
Circuit Current (If no signal)	7.1 mA	7.8 mA
Circuit Current (If color bar signal output)	8.3 mA	14.3 mA
Differential Gain (DG)	0.7%	1.0%
Differential Phase (DP)	0.7°	0.3°

The values shown above are reference values. They are not guaranteed values.

(13) Output dynamic range

The output dynamic range depends on the power supply voltage.

Be careful when using the LSI at low voltage.

The relationship of dynamic range to V_{cc} is shown in Fig. 19.

(14) Bypass capacitor

Since there is a risk of high frequency oscillation, position the power supply bypass capacitor as close as possible to the Vcc pin.

(15) Metal part of back of package

The metal part of the back of the package of this IC also serves as a heat sink. Since it is connected to the GND of the IC, when mounting the IC, connect it to GND or make it NC. Moreover, since there is a risk of shorting, avoid passing a wire other than a GND under the IC.

(16) HVSO6 Reference mounting pattern

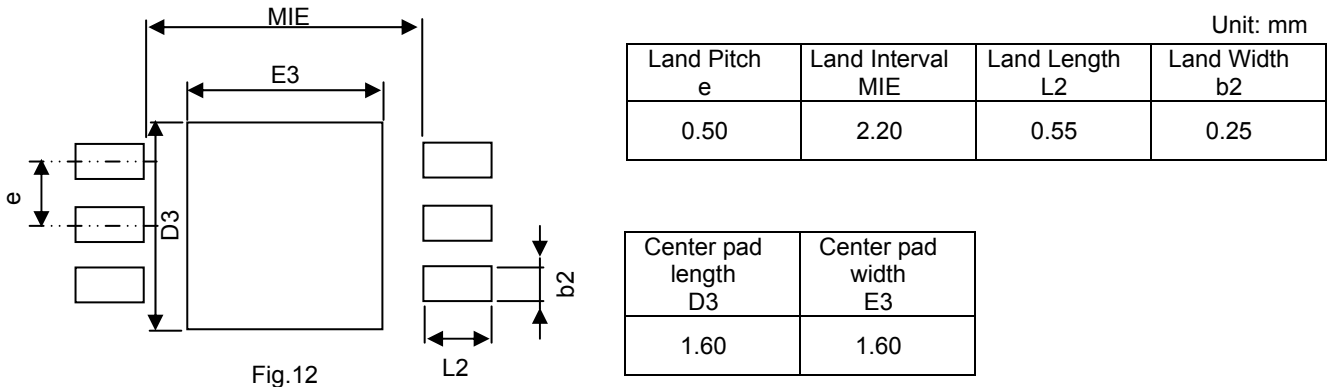

Fig.12

●Application Circuit Example

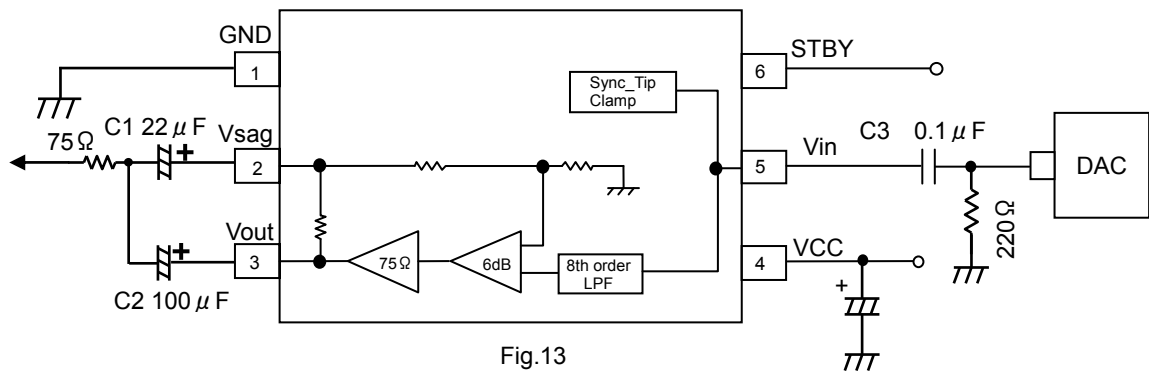

Fig.13

●Reference Data

※Values shown below are reference values. They are not guaranteed values.

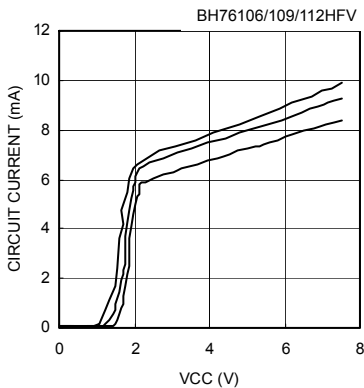

Fig.14 Supply Voltage-Circuit Current

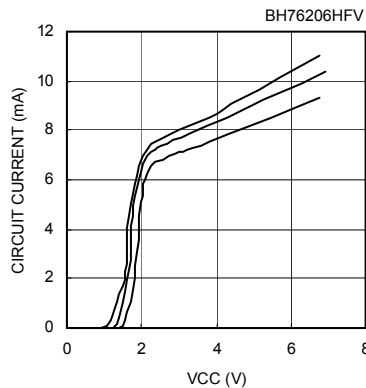

Fig.15 Supply Voltage-Circuit Current

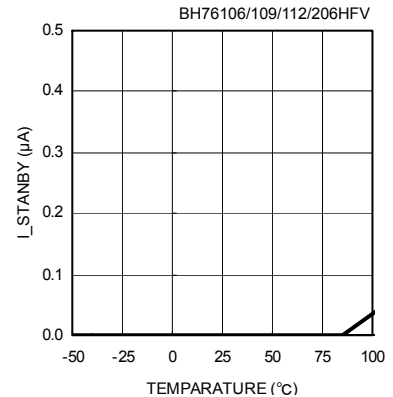

Fig.16 Temperature-Standby Circuit Current

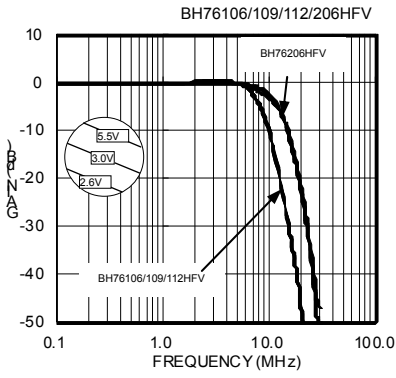

Fig.17 Frequency Characteristic (VCC Characteristic)

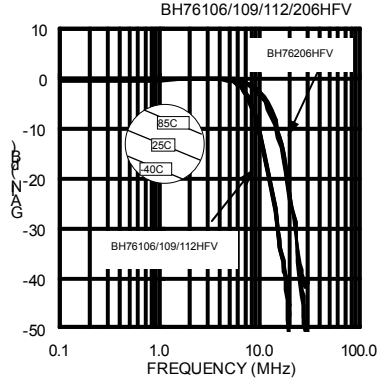

Fig.18 Frequency Characteristic (Temperature Characteristic)

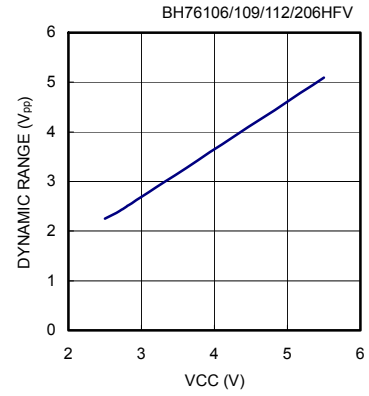

Fig.19 Dynamic Range Characteristic (VCC Characteristic)

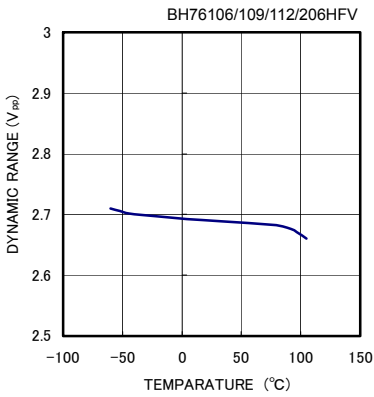

Fig.20 Dynamic Range Characteristic (Temperature Characteristic)

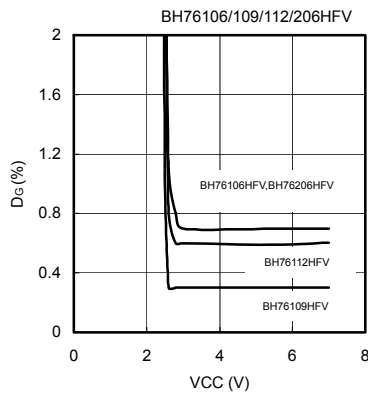

Fig.21 Supply Voltage-D_G

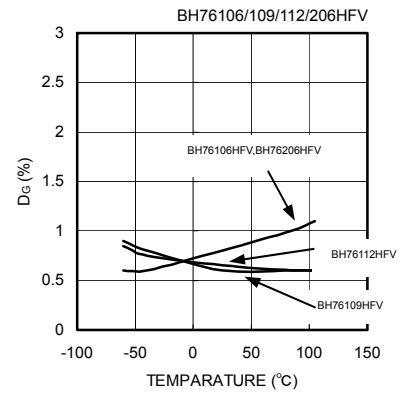

Fig.22 Temperature-D_G

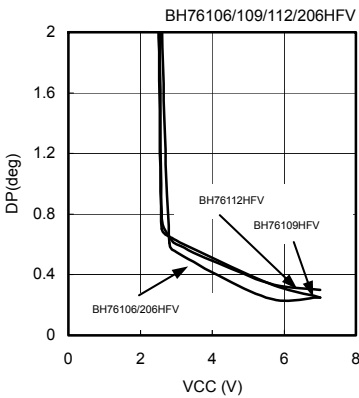

Fig.23 Supply Voltage-D_P

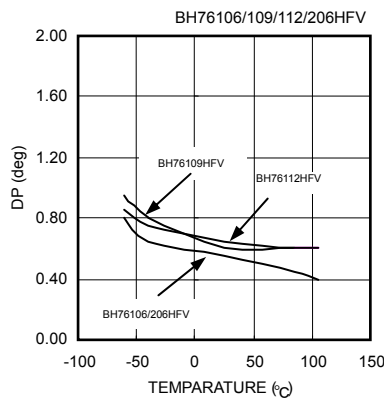

Fig.24 Temperature-D_P

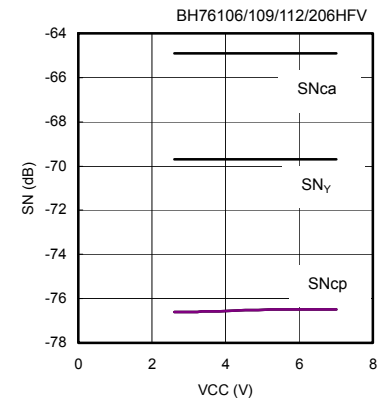

Fig.25 Supply Voltage-S/N

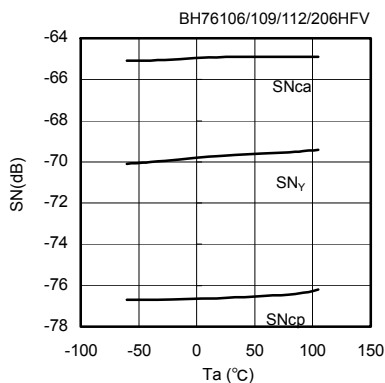

Fig.26 Temperature-S/N

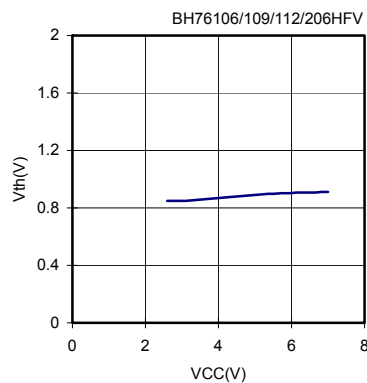

Fig.27 Supply Voltage-V_{th}

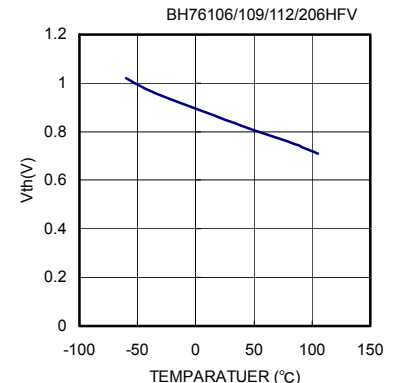
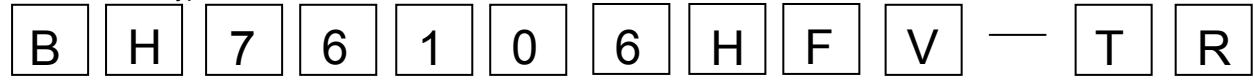

Fig.28 Temperature-V_{th}

● Selection of order type



Part No.

Tape and Reel information

- BH76106HFV
- BH76109HFV
- BH76112HFV
- BH76206HFV

HVSOF6

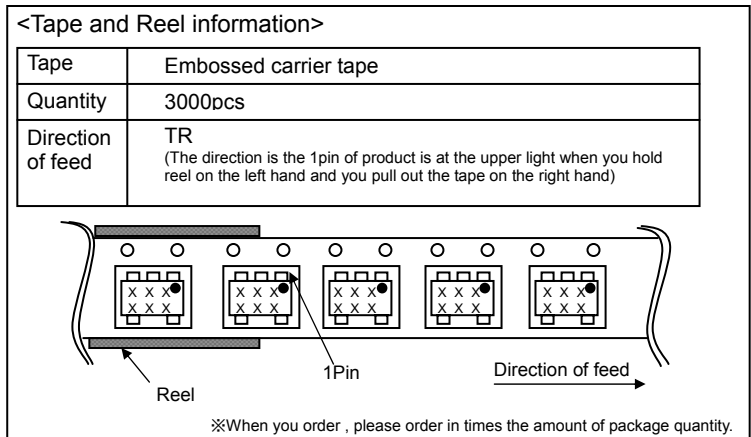
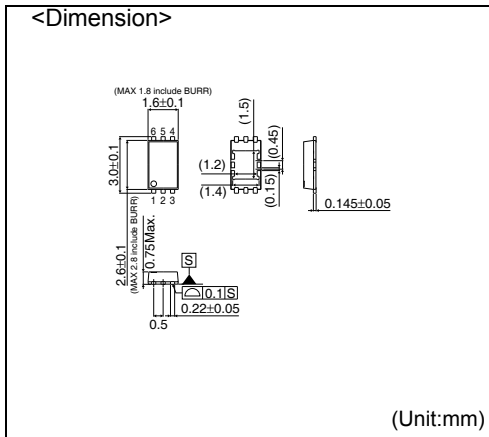

Notice

Precaution on using ROHM Products

- Our Products are designed and manufactured for application in ordinary electronic equipments (such as AV equipment, OA equipment, telecommunication equipment, home electronic appliances, amusement equipment, etc.). If you intend to use our Products in devices requiring extremely high reliability (such as medical equipment ^(Note 1), transport equipment, traffic equipment, aircraft/spacecraft, nuclear power controllers, fuel controllers, car equipment including car accessories, safety devices, etc.) and whose malfunction or failure may cause loss of human life, bodily injury or serious damage to property ("Specific Applications"), please consult with the ROHM sales representative in advance. Unless otherwise agreed in writing by ROHM in advance, ROHM shall not be in any way responsible or liable for any damages, expenses or losses incurred by you or third parties arising from the use of any ROHM's Products for Specific Applications.

(Note1) Medical Equipment Classification of the Specific Applications

JAPAN	USA	EU	CHINA
CLASS III	CLASS III	CLASS II b	CLASS III
CLASS IV		CLASS III	

- ROHM designs and manufactures its Products subject to strict quality control system. However, semiconductor products can fail or malfunction at a certain rate. Please be sure to implement, at your own responsibilities, adequate safety measures including but not limited to fail-safe design against the physical injury, damage to any property, which a failure or malfunction of our Products may cause. The following are examples of safety measures:
 - Installation of protection circuits or other protective devices to improve system safety
 - Installation of redundant circuits to reduce the impact of single or multiple circuit failure
- Our Products are designed and manufactured for use under standard conditions and not under any special or extraordinary environments or conditions, as exemplified below. Accordingly, ROHM shall not be in any way responsible or liable for any damages, expenses or losses arising from the use of any ROHM's Products under any special or extraordinary environments or conditions. If you intend to use our Products under any special or extraordinary environments or conditions (as exemplified below), your independent verification and confirmation of product performance, reliability, etc. prior to use, must be necessary:
 - Use of our Products in any types of liquid, including water, oils, chemicals, and organic solvents
 - Use of our Products outdoors or in places where the Products are exposed to direct sunlight or dust
 - Use of our Products in places where the Products are exposed to sea wind or corrosive gases, including Cl₂, H₂S, NH₃, SO₂, and NO₂
 - Use of our Products in places where the Products are exposed to static electricity or electromagnetic waves
 - Use of our Products in proximity to heat-producing components, plastic cords, or other flammable items
 - Sealing or coating our Products with resin or other coating materials
 - Use of our Products without cleaning residue of flux (even if you use no-clean type fluxes, cleaning residue of flux is recommended); or Washing our Products by using water or water-soluble cleaning agents for cleaning residue after soldering
 - Use of the Products in places subject to dew condensation
- The Products are not subject to radiation-proof design.
- Please verify and confirm characteristics of the final or mounted products in using the Products.
- In particular, if a transient load (a large amount of load applied in a short period of time, such as pulse. is applied, confirmation of performance characteristics after on-board mounting is strongly recommended. Avoid applying power exceeding normal rated power; exceeding the power rating under steady-state loading condition may negatively affect product performance and reliability.
- De-rate Power Dissipation (Pd) depending on Ambient temperature (Ta). When used in sealed area, confirm the actual ambient temperature.
- Confirm that operation temperature is within the specified range described in the product specification.
- ROHM shall not be in any way responsible or liable for failure induced under deviant condition from what is defined in this document.

Precaution for Mounting / Circuit board design

- When a highly active halogenous (chlorine, bromine, etc.) flux is used, the residue of flux may negatively affect product performance and reliability.
- In principle, the reflow soldering method must be used on a surface-mount products, the flow soldering method must be used on a through hole mount products. If the flow soldering method is preferred on a surface-mount products, please consult with the ROHM representative in advance.

For details, please refer to ROHM Mounting specification

Precautions Regarding Application Examples and External Circuits

1. If change is made to the constant of an external circuit, please allow a sufficient margin considering variations of the characteristics of the Products and external components, including transient characteristics, as well as static characteristics.
2. You agree that application notes, reference designs, and associated data and information contained in this document are presented only as guidance for Products use. Therefore, in case you use such information, you are solely responsible for it and you must exercise your own independent verification and judgment in the use of such information contained in this document. ROHM shall not be in any way responsible or liable for any damages, expenses or losses incurred by you or third parties arising from the use of such information.

Precaution for Electrostatic

This Product is electrostatic sensitive product, which may be damaged due to electrostatic discharge. Please take proper caution in your manufacturing process and storage so that voltage exceeding the Products maximum rating will not be applied to Products. Please take special care under dry condition (e.g. Grounding of human body / equipment / solder iron, isolation from charged objects, setting of Ionizer, friction prevention and temperature / humidity control).

Precaution for Storage / Transportation

1. Product performance and soldered connections may deteriorate if the Products are stored in the places where:
 - [a] the Products are exposed to sea winds or corrosive gases, including Cl₂, H₂S, NH₃, SO₂, and NO₂
 - [b] the temperature or humidity exceeds those recommended by ROHM
 - [c] the Products are exposed to direct sunshine or condensation
 - [d] the Products are exposed to high Electrostatic
2. Even under ROHM recommended storage condition, solderability of products out of recommended storage time period may be degraded. It is strongly recommended to confirm solderability before using Products of which storage time is exceeding the recommended storage time period.
3. Store / transport cartons in the correct direction, which is indicated on a carton with a symbol. Otherwise bent leads may occur due to excessive stress applied when dropping of a carton.
4. Use Products within the specified time after opening a humidity barrier bag. Baking is required before using Products of which storage time is exceeding the recommended storage time period.

Precaution for Product Label

QR code printed on ROHM Products label is for ROHM's internal use only.

Precaution for Disposition

When disposing Products please dispose them properly using an authorized industry waste company.

Precaution for Foreign Exchange and Foreign Trade act

Since concerned goods might be fallen under listed items of export control prescribed by Foreign exchange and Foreign trade act, please consult with ROHM in case of export.

Precaution Regarding Intellectual Property Rights

1. All information and data including but not limited to application example contained in this document is for reference only. ROHM does not warrant that foregoing information or data will not infringe any intellectual property rights or any other rights of any third party regarding such information or data.
2. ROHM shall not have any obligations where the claims, actions or demands arising from the combination of the Products with other articles such as components, circuits, systems or external equipment (including software).
3. No license, expressly or implied, is granted hereby under any intellectual property rights or other rights of ROHM or any third parties with respect to the Products or the information contained in this document. Provided, however, that ROHM will not assert its intellectual property rights or other rights against you or your customers to the extent necessary to manufacture or sell products containing the Products, subject to the terms and conditions herein.

Other Precaution

1. This document may not be reprinted or reproduced, in whole or in part, without prior written consent of ROHM.
2. The Products may not be disassembled, converted, modified, reproduced or otherwise changed without prior written consent of ROHM.
3. In no event shall you use in any way whatsoever the Products and the related technical information contained in the Products or this document for any military purposes, including but not limited to, the development of mass-destruction weapons.
4. The proper names of companies or products described in this document are trademarks or registered trademarks of ROHM, its affiliated companies or third parties.

General Precaution

1. Before you use our Products, you are requested to carefully read this document and fully understand its contents. ROHM shall not be in any way responsible or liable for failure, malfunction or accident arising from the use of any ROHM's Products against warning, caution or note contained in this document.
2. All information contained in this document is current as of the issuing date and subject to change without any prior notice. Before purchasing or using ROHM's Products, please confirm the latest information with a ROHM sales representative.
3. The information contained in this document is provided on an "as is" basis and ROHM does not warrant that all information contained in this document is accurate and/or error-free. ROHM shall not be in any way responsible or liable for any damages, expenses or losses incurred by you or third parties resulting from inaccuracy or errors of or concerning such information.