

● Feature 特性

- ◆体积小 Small Size
- ◆低功耗 Low power
- ◆频率范围宽 Wide frequency range

●Electrical specifications 电气参数

型号	Holder Type	Q38 3*8
频率范围	Frequency Toleranc (ΔF) at25°C	32KHz 32.768KHz 40KHz 75KHz 6MHZ~30MHZ
温度频差	Frequency rift	±10ppm~±50ppm
工作温度范围	Operating Temperature Range	-20°C~+70°C to -40°C~+85°C
储存温度范围	Storage Temperature Range	-20°C~+60°C to -55°C~+125°C
老化	Aging 25°C	±3ppm/year Maximum
静电容	Shunt Capacitance (C0)	5pf Maxmum
激励功率	Drive Level	1uw Max
绝缘阻抗	Insulaton Resistance	500Mohms at DC 100V
负载电容	Load Capacitance (CL)	6pf~12.5pf



●Mechanical Dimensions 外型尺寸

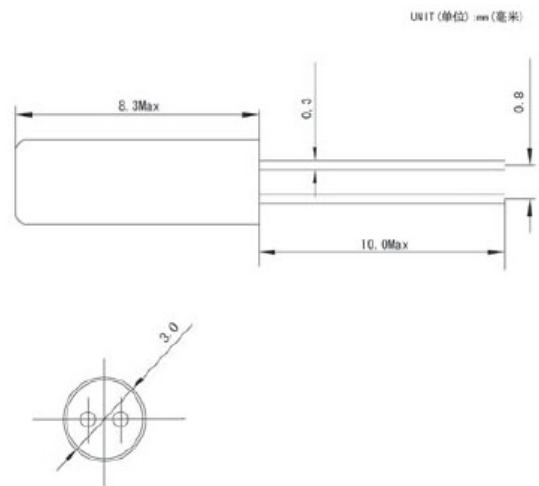

●Equivalent Series Resistance and Mode of Operation
等效电阻和振荡模式

Frequency Range 频率范围	ESR (ohm) 等效阻抗	Mode 振荡模式
30.000-40.000 KHz	40Kohm Max	Fundamental
40.000-75.000 KHz	35Kohm Max	Fundamental

●Reflow condition 回流焊条件

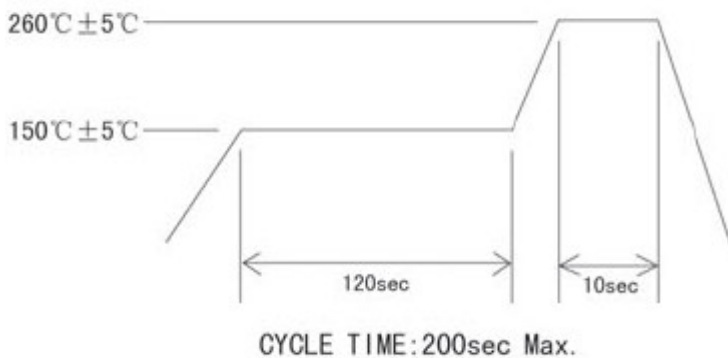

●Frequency VS. Temperature Curne

