

**2, 000 V AC  
breakdown voltage,  
2 Form C and 2 A relays**

# TX RELAYS

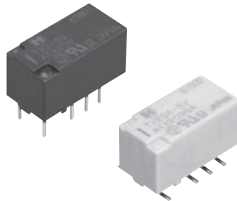

## FEATURES

- 2,000 V breakdown voltage between contact and coil**
- Outstanding surge resistance.**  
1,500 V 10×160μ sec. (FCC part 68) (open contacts)  
2,500 V 2×10μ sec. (Telcordia) (contact and coil)
- Nominal operating power: High sensitivity of 140mW**
- High contact capacity: 2 A 30 V DC**
- Compact size**  
15.0 (L) × 7.4 (W) × 8.2 (H) mm  
.591 (L) × .291 (W) × .323 (H) inch
- High contact reliability**  
High contact reliability is achieved by the use of gold-clad twin crossbar contacts, low-gas formation materials, mold sealing the coil section, and by controlling organic gas in the coil.  
**\*We also offer a range of products with AgPd contacts suitable for use in low level load analog circuits**

## TYPICAL APPLICATIONS

1. Communications (xDSL, Transmission)
2. Measurement
3. Security
4. Home appliances, and audio/visual equipment
5. Medical equipment

## ORDERING INFORMATION

TX **2** - - - - -

Contact arrangement  
2: 2 Form C

Surface-mount availability  
Nil: Standard PC board terminal type  
SA: SA type  
SS: SS type

Operating function  
Nil: Single side stable  
L : 1 coil latching  
L2: 2 coil latching (SET = 1,6 Pin)<sup>2</sup>  
LT: 2 coil latching (SET = 1,12 Pin)

Terminal shape  
Nil: Standard PC board terminal or surface-mount terminal

Nominal coil voltage (DC)<sup>\*1</sup>  
1.5, 3, 4.5, 5, 6, 9, 12, 24, 48V (48V coil type: Single side stable only)

Contact material  
Nil: Standard contact (Ag+Au clad)  
1: AgPd contact (low level load); AgPd+Au clad (stationary), AgPd (movable)

Packing style  
Nil: Tube packing  
X: Tape and reel (picked from 1/3/4/5-pin side)  
W: Tape and reel packing (picked from the 1/3/4/5-pin side)  
    With humidity indicator and silica gel in moisture proof bag  
Z: Tape and reel packing (picked from the 8/9/10/12-pin side)  
Y: Tape and reel packing (picked from the 8/9/10/12-pin side)  
    With humidity indicator and silica gel in moisture proof bag

Note 1) In case of 5 V transistor drive circuit, it is recommended to use 4.5 V type relay  
Note 2) Please contact our sales representative for detailed specifications.

## TYPES

### 1. Standard PC board terminal

Contact arrangement	Nominal coil voltage	Single side stable		2 coil latching	
		Part No.		Part No.	
2 Form C	3 V DC	TX2-3V		TX2-LT-3V	
	4.5 V DC	TX2-4.5V		TX2-LT-4.5V	
	5 V DC	TX2-5V		TX2-LT-5V	
	6 V DC	TX2-6V		TX2-LT-6V	
	9 V DC	TX2-9V		TX2-LT-9V	
	12 V DC	TX2-12V		TX2-LT-12V	
	24 V DC	TX2-24V		TX2-LT-24V	

Standard packing: Tube: 40 pcs.; Case: 1,000 pcs.

Note: Please add "-1" to the end of the part number for AgPd contacts (low level load).

### 2. Surface-mount terminal

#### 1) Tube packing

Contact arrangement	Nominal coil voltage	Single side stable		2 coil latching	
		Part No.		Part No.	
2 Form C	3 V DC	TX2SA-3V		TX2SA-LT-3V	
	4.5 V DC	TX2SA-4.5V		TX2SA-LT-4.5V	
	5 V DC	TX2SA-5V		TX2SA-LT-5V	
	6 V DC	TX2SA-6V		TX2SA-LT-6V	
	9 V DC	TX2SA-9V		TX2SA-LT-9V	
	12 V DC	TX2SA-12V		TX2SA-LT-12V	
	24 V DC	TX2SA-24V		TX2SA-LT-24V	

Standard packing: Tube: 40 pcs.; Case: 1,000 pcs.

Note: Please add "-1" to the end of the part number for AgPd contacts (low level load).

#### 2) Tape and reel packing

Contact arrangement	Nominal coil voltage	Single side stable		2 coil latching	
		Part No.		Part No.	
2 Form C	3 V DC	TX2SA-3V-Z		TX2SA-LT-3V-Z	
	4.5 V DC	TX2SA-4.5V-Z		TX2SA-LT-4.5V-Z	
	5 V DC	TX2SA-5V-Z		TX2SA-LT-5V-Z	
	6 V DC	TX2SA-6V-Z		TX2SA-LT-6V-Z	
	9 V DC	TX2SA-9V-Z		TX2SA-LT-9V-Z	
	12 V DC	TX2SA-12V-Z		TX2SA-LT-12V-Z	
	24 V DC	TX2SA-24V-Z		TX2SA-LT-24V-Z	

Standard packing: Tape and reel: 500 pcs.; Case: 1,000 pcs.

Notes: 1. Tape and reel packing symbol "-Z" is not marked on the relay. "X" type tape and reel packing (picked from 1/3/4/5-pin side) is also available.

2. Tape and reel packing symbol "-Y" is not marked on the relay. "W" type tape and reel packing (picked from 1/3/4/5-pin side) is also available.

3. Please add "-1" to the end of the part number for AgPd contacts (low level load).

4. If you need 1 coil latching or 2 coil latching (L2) for both standard PC board terminal and surface-mount terminal, please contact our sales representative.

## RATING

### 1. Coil data

• Operating characteristics such as 'Operate voltage' and 'Release voltage' are influenced by mounting conditions, ambient temperature, etc.

Therefore, please use the relay within  $\pm 5\%$  of rated coil voltage.

• 'Initial' means the condition of products at the time of delivery.

#### 1) Single side stable

Nominal coil voltage	Pick-up voltage (at 20°C 68°F)	Drop-out voltage (at 20°C 68°F)	Nominal operating current [ $\pm 10\%$ ] (at 20°C 68°F)	Coil resistance [ $\pm 10\%$ ] (at 20°C 68°F)	Nominal operating power	Max. applied voltage (at 20°C 68°F)
3 V DC	75%V or less of nominal voltage* (Initial)	10%V or more of nominal voltage* (Initial)	46.7 mA	64.3 $\Omega$	140 mW	150%V of nominal voltage
4.5 V DC			31 mA	145 $\Omega$		
5 V DC			28.1 mA	178 $\Omega$		
6 V DC			23.3 mA	257 $\Omega$		
9 V DC			15.5 mA	579 $\Omega$		
12 V DC			11.7 mA	1,028 $\Omega$		
24 V DC			5.8 mA	4,114 $\Omega$		

#### 2) 1 coil latching

Nominal coil voltage	Set voltage (at 20°C 68°F)	Reset voltage (at 20°C 68°F)	Nominal operating current [ $\pm 10\%$ ] (at 20°C 68°F)		Coil resistance [ $\pm 10\%$ ] (at 20°C 68°F)		Nominal operating power		Max. applied voltage (at 20°C 68°F)
			Set coil	Reset coil	Set coil	Reset coil	Set coil	Reset coil	
3 V DC	75%V or less of nominal voltage* (Initial)	75%V or less of nominal voltage* (Initial)	66.7 mA	66.7 mA	45 $\Omega$	45 $\Omega$	200 mW	200 mW	150%V of nominal voltage
4.5 V DC			44.5 mA	44.5 mA	101.2 $\Omega$	101.2 $\Omega$			
5 V DC			40 mA	40 mA	125 $\Omega$	125 $\Omega$			
6 V DC			33.3 mA	33.3 mA	180 $\Omega$	180 $\Omega$			
9 V DC			22.2 mA	22.2 mA	405 $\Omega$	405 $\Omega$			
12 V DC			16.7 mA	16.7 mA	720 $\Omega$	720 $\Omega$			
24 V DC			8.3 mA	8.3 mA	2,880 $\Omega$	2,880 $\Omega$			

\*Pulse drive (JIS C 5442-1986)

2. Specifications

Characteristics	Item	Specifications	
Contact	Arrangement	2 Form C	
	Initial contact resistance, max.	Max. 100 mΩ (By voltage drop 6 V DC 1A)	
	Contact material	Standard contact: Ag+Au clad, AgPd contact (low level load): AgPd+Au clad (stationary), AgPd (movable)	
Rating	Nominal switching capacity	Standard contact: 2 A 30 V DC, AgPd contact: 1 A 30 V DC (resistive load)	
	Max. switching power	Standard contact: 60 W (DC), AgPd contact: 30 W (DC) (resistive load)	
	Max. switching voltage	220V DC	
	Max. switching current	Standard contact: 2 A, AgPd contact: 1 A	
	Min. switching capacity (Reference value)*1	10μA 10mV DC	
	Nominal operating power	Single side stable 2 coil latching	140 mW (3 to 24 V DC) 200 mW (3 to 24 V DC)
Electrical characteristics	Insulation resistance (Initial)	Min. 1,000MΩ (at 500V DC) Measurement at same location as "Initial breakdown voltage" section.	
	Breakdown voltage (Initial)	Between open contacts	1,000 Vrms for 1min. (Detection current: 10mA)
		Between contact and coil	2,000 Vrms for 1min. (Detection current: 10mA)
		Between contact sets	1,000 Vrms for 1min. (Detection current: 10mA)
	Surge breakdown voltage (Initial)	Between open contacts	1,500 V (10×160μs) (FCC Part 68)
		Between contacts and coil	2,500 V (2×10μs) (Telcordia)
	Temperature rise (at 20°C 68°F)		Max. 50°C (By resistive method, nominal coil voltage applied to the coil; contact carrying current: 2A.)
	Operate time [Set time] (at 20°C 68°F)		Max. 4 ms [Max. 4 ms] (Nominal coil voltage applied to the coil, excluding contact bounce time.)
Release time [Reset time] (at 20°C 68°F)		Max. 4 ms [Max. 4 ms] (Nominal coil voltage applied to the coil, excluding contact bounce time.) (without diode)	
Mechanical characteristics	Shock resistance	Functional	Min. 750 m/s <sup>2</sup> (Half-wave pulse of sine wave: 6 ms; detection time: 10μs.)
		Destructive	Min. 1,000 m/s <sup>2</sup> (Half-wave pulse of sine wave: 6 ms.)
	Vibration resistance	Functional	10 to 55 Hz at double amplitude of 3.3 mm (Detection time: 10μs.)
		Destructive	10 to 55 Hz at double amplitude of 5 mm
Expected life	Mechanical	Min. 10 <sup>8</sup> (at 180 cpm)	
	Electrical (Standard contact)	Min. 10 <sup>5</sup> (2 A 30 V DC resistive), 5×10 <sup>5</sup> (1 A 30 V DC resistive) (at 20 cpm)	
Conditions	Conditions for operation, transport and storage*2	Ambient temperature: -40°C to +85°C (up to 24 V coil) -40°F to +185°F (up to 24 V coil) [-40°C to +70°C (48 V coil) -40°F to +158°F (48 V coil)]; Humidity: 5 to 85% R.H. (Not freezing and condensing at low temperature)	
	Max. operating speed (at rated load)	20 cpm	
Unit weight		Approx. 2 g .071 oz	

Notes: \*1 This value can change due to the switching frequency, environmental conditions, and desired reliability level, therefore it is recommended to check this with the actual load. (AgPd contact type is available for low level load switching [10V DC, 10mA max. level]).

\*2 Refer to "AMBIENT ENVIRONMENT" in GENERAL APPLICATION GUIDELINES.

REFERENCE DATA

1. Maximum switching capacity

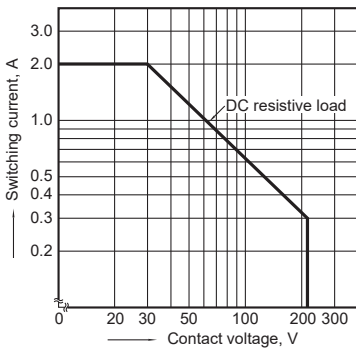

2. Life curve

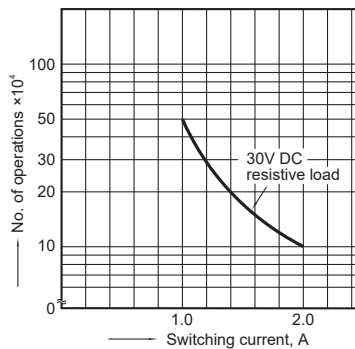

3. Mechanical life

Tested sample: TX2-5V, 10 pcs.  
Operating speed: 180 cpm

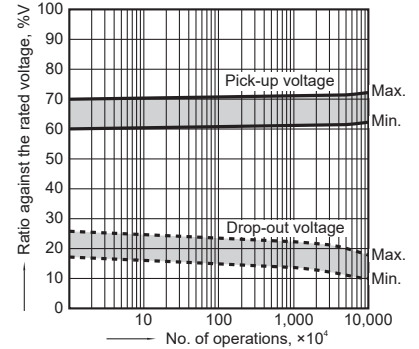

4. Electrical life (2A 30V DC resistive load)

Tested sample: TX2-5V, 6 pcs.  
Operating speed: 20 cpm

Change of pick-up and drop-out voltage

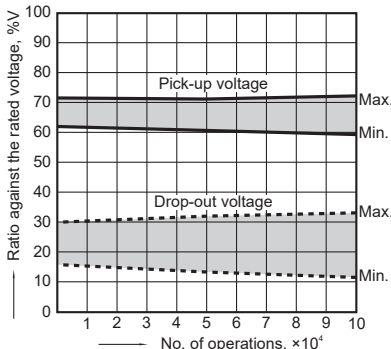

Change of contact resistance

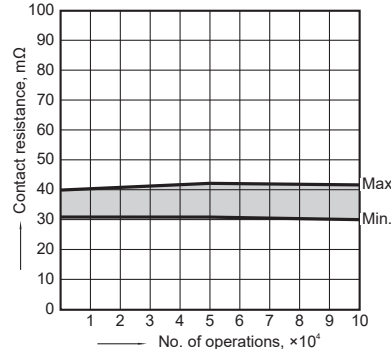

5. Coil temperature rise

Tested sample: TX2-5V, 6 pcs.  
Point measured: Inside the coil  
Ambient temperature: 25°C 77°F, 85°C 185°F

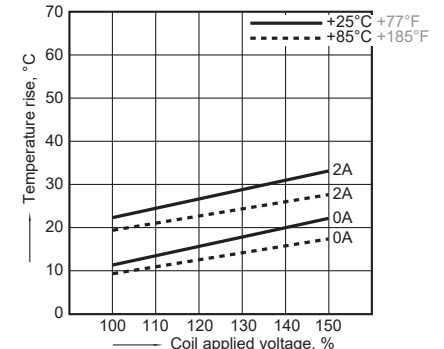

6-(1). Operate and release time (with diode)

Tested sample: TX2-5V, 10 pcs.

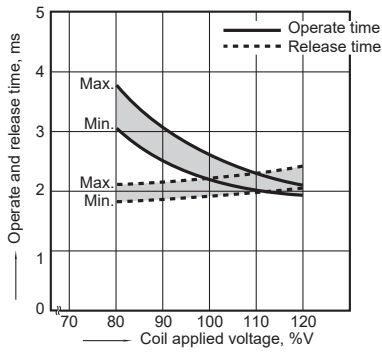

6-(2). Operate and release time (without diode)

Tested sample: TX2-5V, 10 pcs.

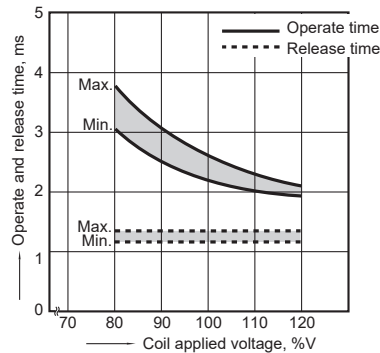

7. Ambient temperature characteristics

Tested sample: TX2-5V, 5 pcs.

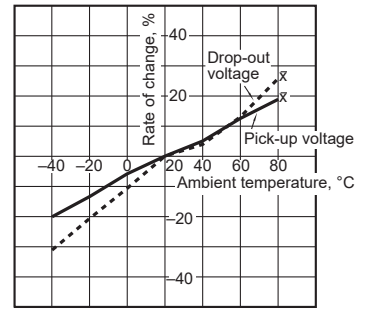

8-(1). High frequency characteristics (Isolation)

Tested sample: TX2-12V, 2 pcs.

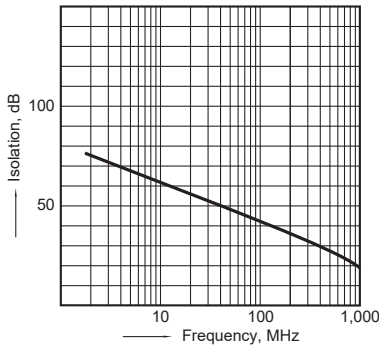

8-(2). High frequency characteristics (Insertion loss)

Tested sample: TX2-12V, 2 pcs.

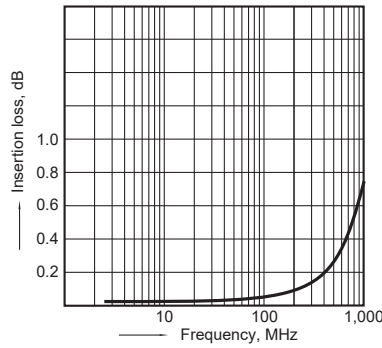

9. Malfunctional shock (single side stable)

Tested sample: TX2-5V, 6 pcs.

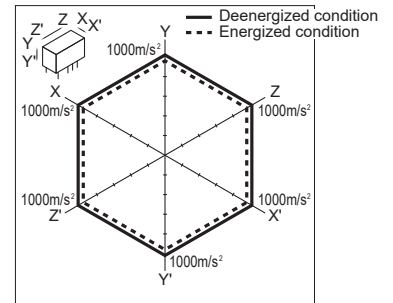

10-(1). Influence of adjacent mounting

Tested sample: TX2-12V, 6 pcs.

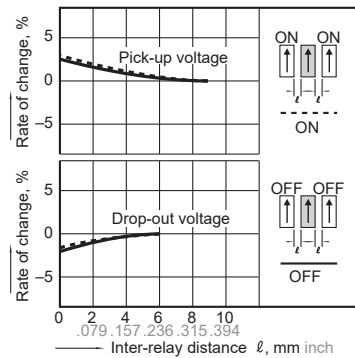

10-(2). Influence of adjacent mounting

Tested sample: TX2-12V, 6 pcs.

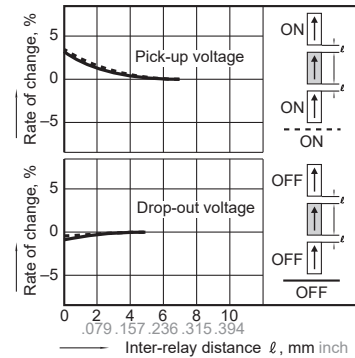

11. Pulse dialing test

Tested sample: TX2-5V, 6 pcs.  
(35 mA 48 V DC wire spring relay load)

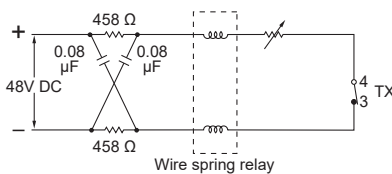

Change of pick-up and drop-out voltage

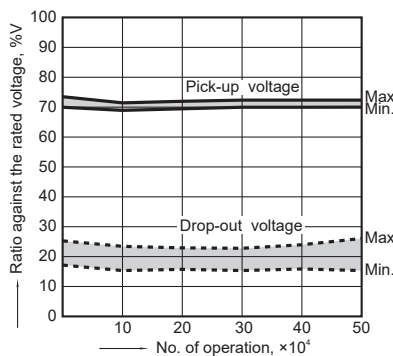

Change of contact resistance

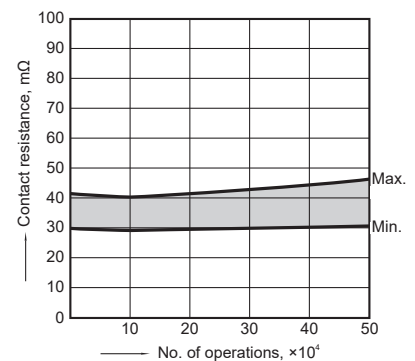

Note: Data of surface-mount type are the same as those of PC board terminal type.

# DIMENSIONS (mm inch)

The CAD data of the products with a **CAD Data** mark can be downloaded from <https://industrial.panasonic.com/ac/e/>

## 1. Standard PC board terminal

**CAD Data**

**Single side stable type**  
External dimensions  
Standard PC board terminal

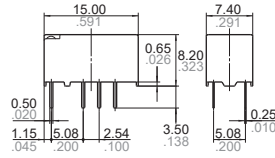

General tolerance:  $\pm 0.3 \pm 0.12$

**2 coil latching type**  
External dimensions  
Standard PC board terminal

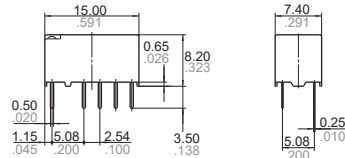

General tolerance:  $\pm 0.3 \pm 0.12$

PC board pattern (Bottom view)

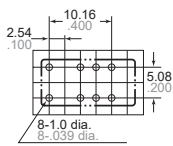

Tolerance:  $\pm 0.1 \pm 0.04$

Schematic (Bottom view) Single side stable

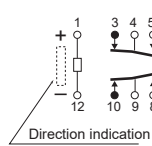

(Deenergized condition)

PC board pattern (Bottom view)

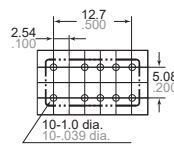

Tolerance:  $\pm 0.1 \pm 0.04$

Schematic 2 coil latching (Bottom view)

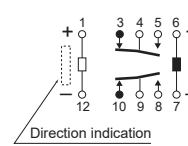

(Operating function LT)

(Reset condition)

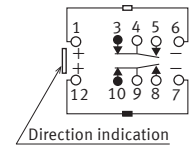

(Operating function L2)

(Reset condition)

Note: If you need PC board pattern or schematic, please contact our sales representative.

## 2. Surface-mount terminal

**CAD Data**



Type	External dimensions (General tolerance: $\pm 0.3 \pm 0.12$ )		Suggested mounting pad (Top view) (Tolerance: $\pm 0.1 \pm 0.04$ )	
	Single side stable type	2 coil latching type	Single side stable type	2 coil latching type
SA type				

Schematic (Top view)

Single side stable

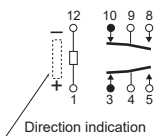

(Deenergized condition)

2 coil latching

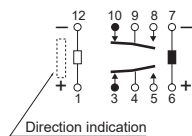

(Operating function LT)

(Reset condition)

2 coil latching

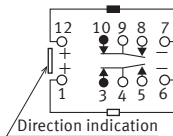

(Operating function L2)

(Reset condition)

Note: If you need PC board pattern or schematic, please contact our sales representative.

## NOTES

### 1. Packing style

1) The relay is packed in a tube with the relay orientation mark on the left side, as shown in the figure below.

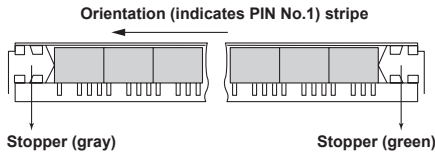

2) Tape and reel packing  
(Surface-mount terminal type)  
(1) Tape dimensions

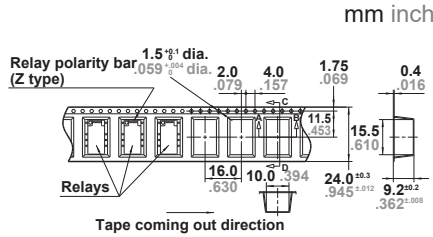

### 2. Automatic insertion

To maintain the internal function of the relay, the chucking pressure should not exceed the values below.

Chucking pressure in the direction A:

4.9 N {500gf} or less

Chucking pressure in the direction B:

9.8 N {1 kgf} or less

Chucking pressure in the direction C:

9.8 N {1 kgf} or less

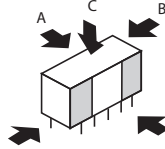

Please chuck the  portion.  
Avoid chucking the center of the relay.  
In addition, excessive chucking pressure to the pinpoint of the relay should be avoided.

(2) Dimensions of plastic reel

mm inch

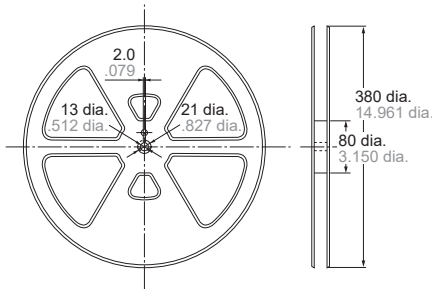

## Ambient Environment

### Usage, Transport, and Storage Conditions

During usage, storage, or transportation, avoid locations subjected to direct sunlight and maintain normal temperature, humidity and pressure conditions.

### Temperature/Humidity

When transporting or storing relays while they are tube packaged, there are cases the temperature may differ from the allowable range. In this case be sure to check the individual specifications.

Also allowable humidity level is influenced by temperature, please check charts shown below and use relays within mentioned conditions. (Allowable temperature values)

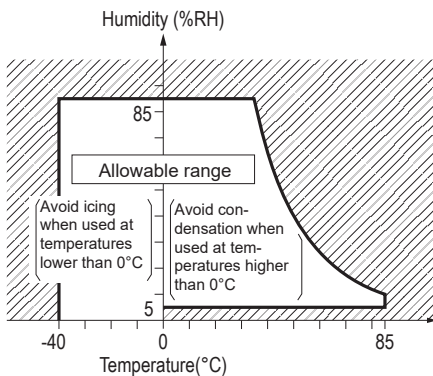

Please refer to "the latest product specifications" when designing your product.

• Requests to customers :

<https://industrial.panasonic.com/ac/e/salespolicies/>

# GUIDELINES FOR SIGNAL RELAYS USAGE

For cautions for use, please read “GUIDELINES FOR RELAY USAGE”.  
[https://industrial.panasonic.com/ac/e/control/relay/cautions\\_use/index.jsp](https://industrial.panasonic.com/ac/e/control/relay/cautions_use/index.jsp)

## Precautions for Coil Input

### ■ Long term current carrying

A circuit that will be carrying a current continuously for long periods without relay switching operation. (circuits for emergency lamps, alarm devices and error inspection that, for example, revert only during malfunction and output warnings with form B contacts) Continuous, long-term current to the coil will facilitate deterioration of coil insulation and characteristics due to heating of the coil itself.

For circuits such as these, please use a magnetic-hold type latching relay. If you need to use a single stable relay, use a sealed type relay that is not easily affected by ambient conditions and make a failsafe circuit design that considers the possibility of contact failure or disconnection.

### ■ DC Coil operating power

Steady state DC current should be applied to the coil. The wave form should be rectangular. If it includes ripple, the ripple factor should be less than 5%.

However, please check with the actual circuit since the electrical characteristics may vary. The rated coil voltage should be applied to the coil and the set/reset pulse time of latching type relay differs for each relays, please refer to the relay's individual specifications.

### ■ Coil connection

When connecting coils of polarized relays, please check coil polarity (+,-) at the internal connection diagram (Schematic). If any wrong connection is made, it may cause unexpected malfunction, like abnormal heat, fire and so on, and circuit do not work. Avoid impressing voltages to the set coil and reset coil at the same time.

### ■ Maximum allowable voltage and temperature rise

Proper usage requires that the rated coil voltage be impressed on the coil. Note, however, that if a voltage greater than or equal to the maximum continuous voltage is impressed on the coil, the coil may burn or its layers short due to the temperature rise. Furthermore, do not exceed the usable ambient temperature range listed in the catalog.

### ● Maximum allowable voltage for coil

In addition to being a requirement for relay operation stability, the maximum continuous impressed coil voltage is an important constraint for the prevention of such problems as thermal deterioration or deformity of the insulation material, or the occurrence of fire hazards.

### ● Temperature rise due to pulse voltage

When a pulse voltage with ON time of less than 2 minutes is used, the coil temperature rise bears no relationship to the ON time. This varies with the ratio of ON time to OFF time, and compared with continuous current passage, it is rather small. The various relays are essentially the same in this respect.

Current passage time	(%)
For continuous passage	Temperature rise value is 100%
ON : OFF = 3 : 1	About 80%
ON : OFF = 1 : 1	About 50%
ON : OFF = 1 : 3	About 35%

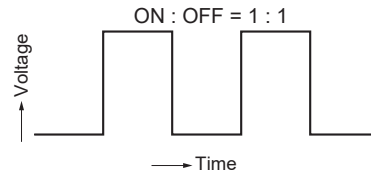

### ■ Operate voltage change due to coil temperature rise (Hot start)

In DC relays, after continuous passage of current in the coil, if the current is turned OFF, then immediately turned ON again, due to the temperature rise in the coil, the pick-up voltage will become somewhat higher. Also, it will be the same as using it in a higher temperature atmosphere. The resistance/temperature relationship for copper wire is about 0.4% for 1°C, and with this ratio the coil resistance increases. That is, in order to operate of the relay, it is necessary that the voltage be higher than the pick-up voltage and the pick-up voltage rises in accordance with the increase in the resistance value. However, for some polarized relays, this rate of change is considerably smaller.

## Ambient Environment

### •Dew condensation

Condensation occurs when the ambient temperature drops suddenly from a high temperature and humidity, or the relay and microwave device is suddenly transferred from a low ambient temperature to a high temperature and humidity. Condensation causes the failures like insulation deterioration, wire disconnection and rust etc.

Panasonic Corporation does not guarantee the failures caused by condensation.

The heat conduction by the equipment may accelerate the cooling of device itself, and the condensation may occur.

Please conduct product evaluations in the worst condition of the actual usage. (Special attention should be paid when high temperature heating parts are close to the device. Also please consider the condensation may occur inside of the device.)

### •Icing

Condensation or other moisture may freeze on relays when the temperature become lower than 0°C. This icing causes the sticking of movable portion, the operation delay and the contact conduction failure etc. Panasonic Corporation does not guarantee the failures caused by the icing.

The heat conduction by the equipment may accelerate the cooling of relay itself and the icing may occur. Please conduct product evaluations in the worst condition of the actual usage.

### •Low temperature and low humidity

The plastic becomes brittle if the switch is exposed to a low temperature, low humidity environment for long periods of time.

### •High temperature and high humidity

Storage for extended periods of time (including transportation periods) at high temperature or high humidity levels or in atmospheres with organic gases or sulfide gases may cause a sulfide film or oxide film to form on the surfaces of the contacts and/or it may interfere with the functions. Check out the atmosphere in which the units are to be stored and transported.

### •Package

In terms of the packing format used, make every effort to keep the effects of moisture, organic gases and sulfide gases to the absolute minimum.

### •Storage requirements

Since the SMD type is sensitive to humidity it is packaged with tightly sealed anti-humidity packaging. However, when storing, please be careful of the following.

- 1) Please use promptly once the anti-humidity pack is opened. (Signal relay: within 72 hours, Max. 30°C/70% RH). If left with the pack open, the relay will absorb moisture which will cause thermal stress when reflow mounting and thus cause the case to expand. As a result, the seal may break.

- 2) If relays will not be used within 72 hours, please store relays in a humidity controlled desiccator or in an anti-humidity bag to which silica gel has been added.

\*If the relay is to be soldered after it has been exposed to excessive humidity atmosphere, cracks and leaks can occur. Be sure to mount the relay under the required mounting conditions

- 3) The following cautionary label is affixed to the anti-humidity pack.

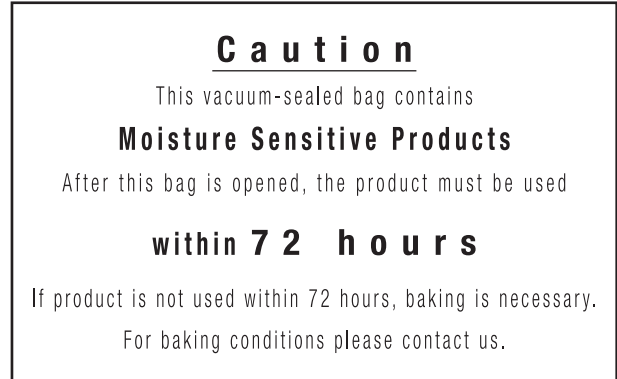

### •Silicon

When a source of silicone substances (silicone rubber, silicone oil, silicone coating materials and silicone filling materials etc.) is used around the relay, the silicone gas (low molecular siloxane etc.) may be produced.

This silicone gas may penetrate into the inside of the relay. When the relay is kept and used in this condition, silicone compound may adhere to the relay contacts which may cause the contact failure. Do not use any sources of silicone gas around the relay (Including plastic seal types).

### •NOx Generation

When relay is used in an atmosphere high in humidity to switch a load which easily produces an arc, the NOx created by the arc and the water absorbed from outside the relay combine to produce nitric acid. This corrodes the internal metal parts and adversely affects operation. Avoid use at an ambient humidity of 85% RH or higher (at 20°C). If use at high humidity is unavoidable, please contact our sales representative.

## Others

### ■ Cleaning

- 1) Although the environmentally sealed type relay (plastic sealed type, etc.) can be cleaned, avoid immersing the relay into cold liquid (such as cleaning solvent) immediately after soldering. Doing so may deteriorate the sealing performance.
- 2) Surface mount terminal type relay is sealed type and it can be cleaned by immersion. Use pure water or alcohol-based cleaning solvent.

- 3) Cleaning with the boiling method is recommended (The temperature of cleaning liquid should be 40°C or lower).

Avoid ultrasonic cleaning on relays. Use of ultrasonic cleaning may cause breaks in the coil or slight sticking of the contacts due to the ultrasonic energy.

Please refer to "**the latest product specifications**" when designing your product.

•Requests to customers:

<https://industrial.panasonic.com/ac/e/salespolicies/>



---

Please contact .....

**Panasonic Corporation**

Electromechanical Control Business Division

■ 1006, Oaza Kadoma, Kadoma-shi, Osaka 571-8506, Japan  
[industrial.panasonic.com/ac/e/](http://industrial.panasonic.com/ac/e/)

**Panasonic**<sup>®</sup>

©Panasonic Corporation 2020