

Features

- 6~36VDC wide input range
- Pin-out compatible with LM78xx linear regulators
- High Efficiency up to 92%
- Output Short Circuit Protection:
Hiccup & Auto Recovery
- Over Temperature Protection
- Lead Free Design, RoHS Compliant
- Meet Safety Standard / Approval: IEC / EN60950-1

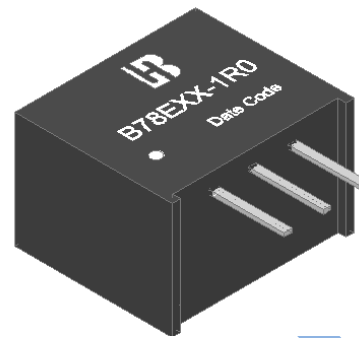

Description

The B78EXX-1R0 Series are non-isolated DC/DC converters suited to replace 1.0 Amp LM78xx linear regulators. Designed with highly efficiency, allow the operating temperature range of these units to be -40°C to +85°C in a 11 .6x7.5x10.2mm non-conducted black plastic case. Further features include wide 6~36VDC input voltage range, short-circuits protection and over temperature protection.

Technical Specification

All specifications are typical at nominal input, full load and 25°C unless otherwise stated.

Model Number	Input Voltage Range	Output Voltage (V)	Output Current (mA)		Eff. ⁽²⁾ (%)		Capacitive Load, max. ⁽³⁾ (uF)
			Min. Load ⁽¹⁾	Full. Load	Vin_min	Vin_max	
B78E03-1R0	6-36V Nominal:24V	3.3	0	1000	88	78	1000
B78E05-1R0	7-36V Nominal:24V	5	0	1000	92	84	1000
B78E12-1R0	15-36V Nominal:24V	12	0	1000	96	92	1000

Input Specifications

Input voltage	B78E03-1R0	24V nominal input	6~36V
	B78E05-1R0	24V nominal input	7~36V
	B78E12-1R0	24V nominal input	15~36V

Input filter Capacitor type

Environmental Specifications

Operating ambient temperature	-40°C to +85°C (with derating)
Maximum case temperature	+105°C
Storage temperature range	-50°C to +125°C
Relative humidity	95% RH max.
Temperature coefficient	±0.03% / °C max.

Output Specifications

Output current		1A max.
Voltage accuracy	0 -100% load and 24Vin	±1.5% typ. 3.3V ±4% max >=5V ±3% max.
Minimum load		0mA
Line regulation	Full load	±0.75% max.
Load Regulation	10 -100% load	±1.5% max.
Ripple and Noise (20MHz Bandwidth)		85mVp-p max.
Capacitive load		See table
Short Circuit Protection(SCP)		Hiccup, automatic recovery
Over Temperature Protection(OTP)	The IC Thermal Shutdown Temperature	150°C typ

General Specifications

Efficiency		See table
Switching frequency (Fixed)	Pulse width modulation (PWM)	520kHz
Reliability, calculated MTBF		10 × 10 ⁵ Hrs

Physical Specifications

Case material		Plastic (UL94 V-0)
Dimensions		0.46 × 0.295 × 0.4 Inch (11.6 × 7.5 × 10.2 mm)
Weight		1.6g (0.057oz) typ.

Attention: Please don't use it in overload condition.

Power Derating Curve

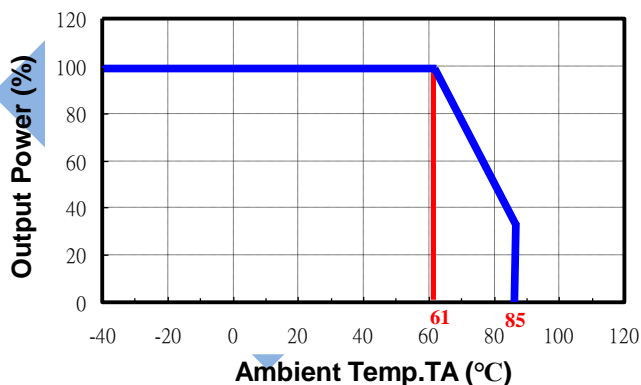

Note

1. Io below this value will not damage these converters, however, they may not meet all listed specifications.
2. Typical value, tested at nominal input and full load.
3. Specifications subject to change without notice.
4. This power module is not internally fused. The input line fuse must always be used.

Mechanical Dimensions

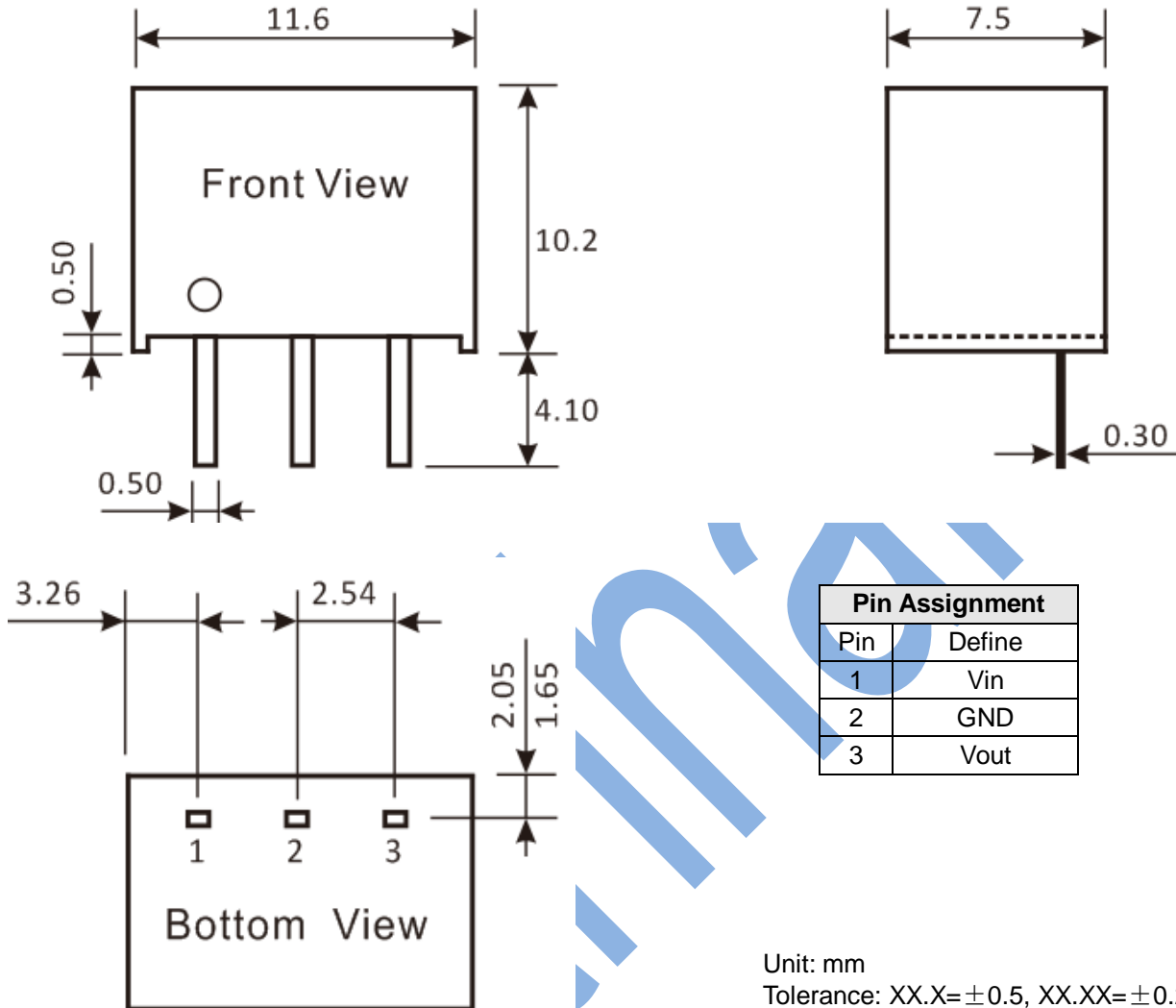

Test Configurations

All specifications are typical at nominal input, full load and 25°C unless otherwise stated.

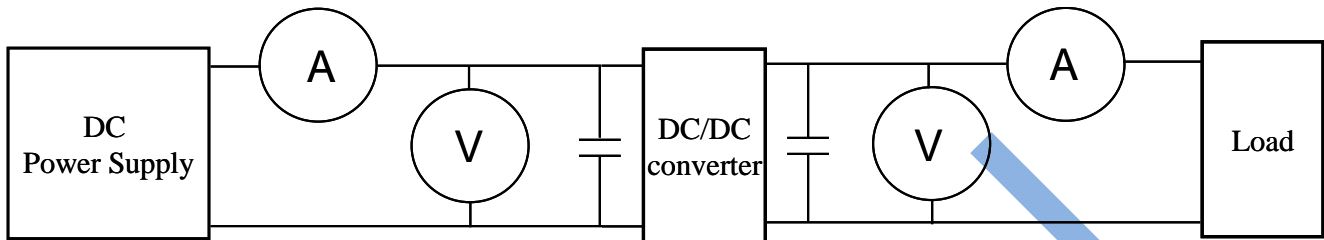

- ⊙DC Power Supply: It offers a wide voltage and current range precisely.
- ⊙Current meter (A): Accuracy → 200μA ~ 200mA 4 ranges $\pm(0.2\% \text{ rdg} + 2 \text{ digits})$
2000mA ~ 20A 2 ranges $\pm(0.3\% \text{ rdg} + 2 \text{ digits})$.
- ⊙Voltage meter (V): Accuracy → $\pm(0.03\% \text{ rdg} + 4 \text{ digits})$.
- ⊙Load: At full load.
- ⊙Wires: The resistance of the wires must be small.

1. Ripple and Noise: as shown below. The bandwidth is 0-20MHz.

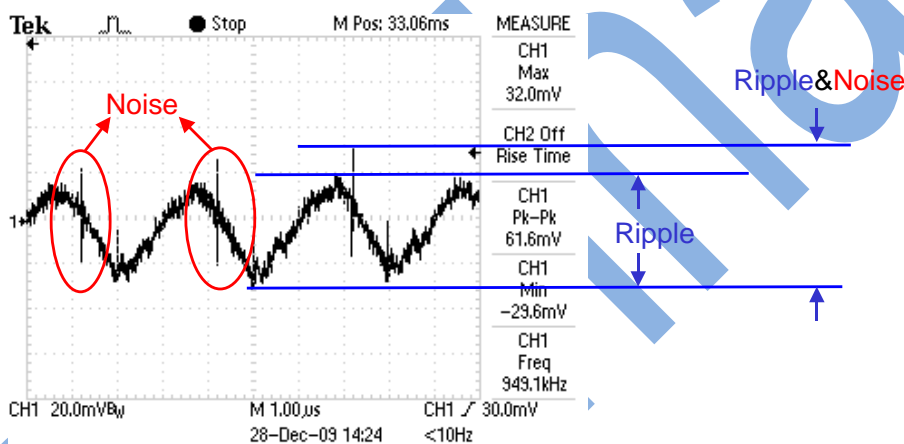

Output Ripple&Noise measurement test circuit: as shown below.

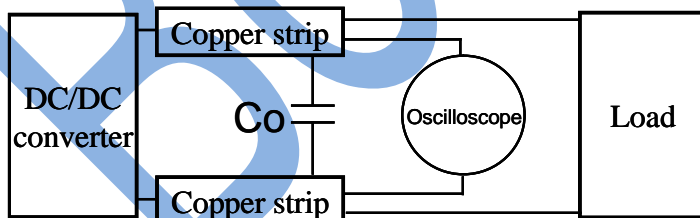

Co: usually 1uF MLCC and 10uF tantalum capacitor.

2. **Temperature derating curve:** The DC-DC converter will operate over a wider temperature range if less power is drawn from the output and the device is already running. The temperature derating curve shows the operating power-temperature range. As shown below.

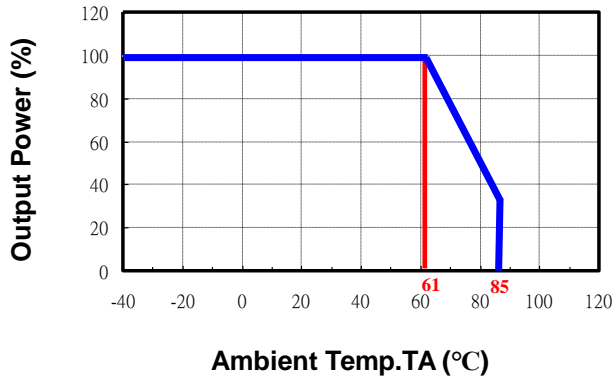

3. **Application circuit:** as shown below. C1=10uF/50V MLCC, C2 =22uF/25V MLCC.

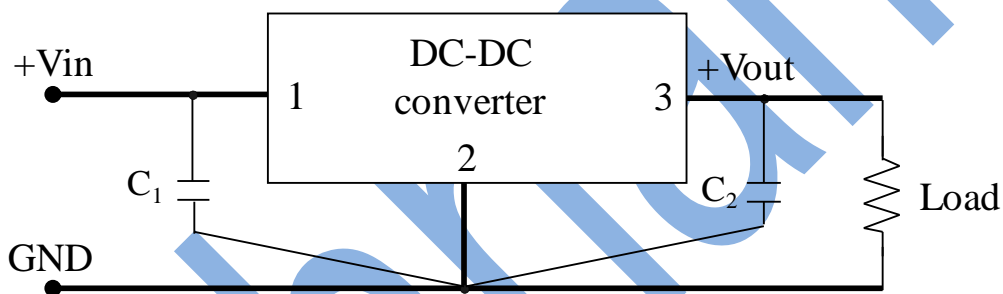

4. EMC Filter Suggestion according to EN55032 CLASSB:

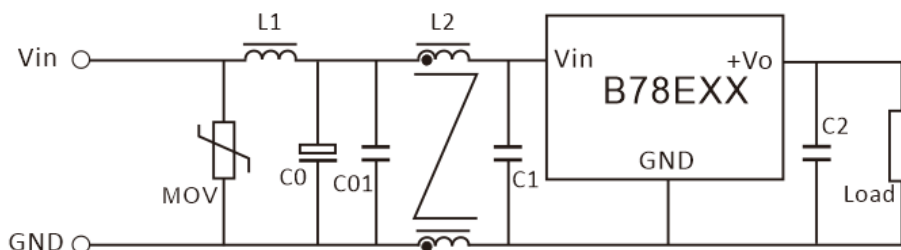

MOV	L1	C0	C01	L2	C1	C2
20D470K	300uH	470uF/50V	4.7uF/50V MLCC	5mH	10uF/50V MLCC	22uF/10V MLCC