

SPECIFICATION FOR APPROVAL

規 格 書

Customer (客戶名稱): _____

Customer P/N(客戶番號): _____

Our P/N (本廠番號): FS28DS0430-H15.3-BV (烤黑)

Approval Date(日期): 2020.9.11

Environment Request(環境標準):

Non-RoHS (非 RoHS 標準)

RoHS (RoHS 標準)

REACH (REACH 標準)

Others (其他)

CUSTOMER'S APPROVED SIGNATURE		



泰州福聲電子科技有限公司

Taizhou Fusheng Electronic Technology Co.,Ltd.

Adds: No168 of FengHuang Road West,Hailing District ,Taizhou .

地址: 江蘇省泰州市海陵區鳳凰西路168號

Tel: +86-523-86219066

Fax: +86-523- 81601108

[Http://www.tzfsdz.com](http://www.tzfsdz.com)

E-mail: sales@electronic-tech.cn

	DESINGER	CHECKED	APPROVED
SIGNATURE			
DATE			

Speaker Specification

Part No.	Customer No 顧客型號		Customer code 顧客編號	
	Our Part No 本廠編號	FS28DS0430-H15.3-BV (烤黑)		Revision 版本 A
No.	Item 項目	Specification 規格	Testing Condition 測試條件	
1.	Rated Imp 共稱阻抗	4ohm±15%	At 1kHz	
2.	Resonance Freq 最低共振周波數	280Hz±20%	Without Baffle	
3.	Output S.P.L. 出力音壓	83±3dB	At 0.1m 0.1w 0.6,1.0,1.5,2.0KHz Average	
4.	Rated Power 定格入力	at 3.0W	at 3.46 Vrms	
5.	Max Power 最大入力	at 5.0W	at 4.47Vrms	
6.	Frequency Range 實效頻寬	FO----20kHz		
7.	Operation 可靠性試驗	Must Be Normal at Rated Frequency Range	Program Source 3.0 W FO~10kHz	
8.	Buzzes & Rattles 異常音試驗	Should not be audible buzz and rattle at Rated Frequency Range 無異常聲	Sine Wave Between (正弦波入力) at 4.90Vrms / FO---- 10kHz	
9.	T H D 失真	10% Max	Rated Power Input 1000Hz	
10.	Magnet 磁鐵	NdFeB		
11.	Operating Temperature 動作溫度	-20°C to +50°C		
12.	Storage Temperature 儲存溫度	-30°C to +60°C		
13.	Weight 重量	5.1g/PC		

14.	Cold Test 耐寒試驗	Must be normal after having been in a test chamber for 96 hours at the condition of $-20^{\circ}\text{C} \pm 2^{\circ}\text{C}$ and then left 2 hours in a room. ($-20^{\circ}\text{C} \pm 2^{\circ}\text{C}$, 96 小時試驗室溫兩小時後, 無異常)
15.	Heat Test 耐熱試驗	Must be normal after having been in a test chamber for 96 hours at the condition of $+50^{\circ}\text{C} \pm 2^{\circ}\text{C}$ 90~95% R.H and then left 2 hours in a room. ($+50^{\circ}\text{C} \pm 2^{\circ}\text{C}$ 90~95% R.H 96 小時試驗常溫 2 小時後, 無異常的不良)
16.	Load Test 連續負荷試驗	Must be normal after load test :white noise 3.0W 96 hours. At rated frequency range (白噪音 3.0 W 連續 96 小時試驗後無異常的不良)
17	Short Term Maximum Power test 瞬間最大功率測試	Test for 1 hour under maximum power. Input shall be white noise in rated frequency response. And the signal will be 1 second on, 59 seconds off, total 60 cycles at rated frequency range, Must be normal after the test (白噪音 5.0W, 1 秒開 59 秒關, 連續 60 迴圈, 試驗後無異常之不良)
18.	Polarity 極性	When a DC source ' s "+" polarity is attached to speaker's "+" polarity, "-" polarity is attached speaker's "-" polarity, the membrane will move forward. Red wire is "+" and the black wire is "-". (接線板由側為正極, 左側為負極)
19.	Drop Test 跌落試驗	Drop the speakers contained in normal box onto a board 5mm thick 2 times from a height of 1.0m . Must be normal after the test (在厚 5mm 的木板上從 1.0m 的高度跌落 2 次, 無異常不良)
20.	Terminal strength 端子強度	A static load of 5.0N shall be applied to the terminals for 10s in any direction between terminal block and frame and between terminal block and fasten terminal. Must be normal after the test (端子板和支架或焊片任一方向上 5.0N 的力 10s 無異常)

Temperature Cycle Test(5 cycle)

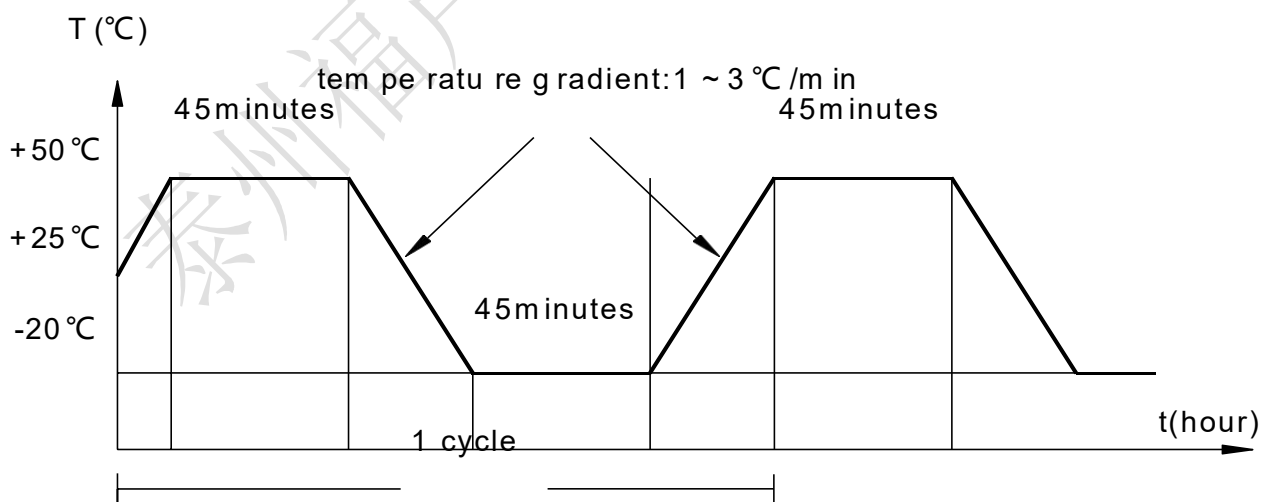

Frequency Response

频响曲线

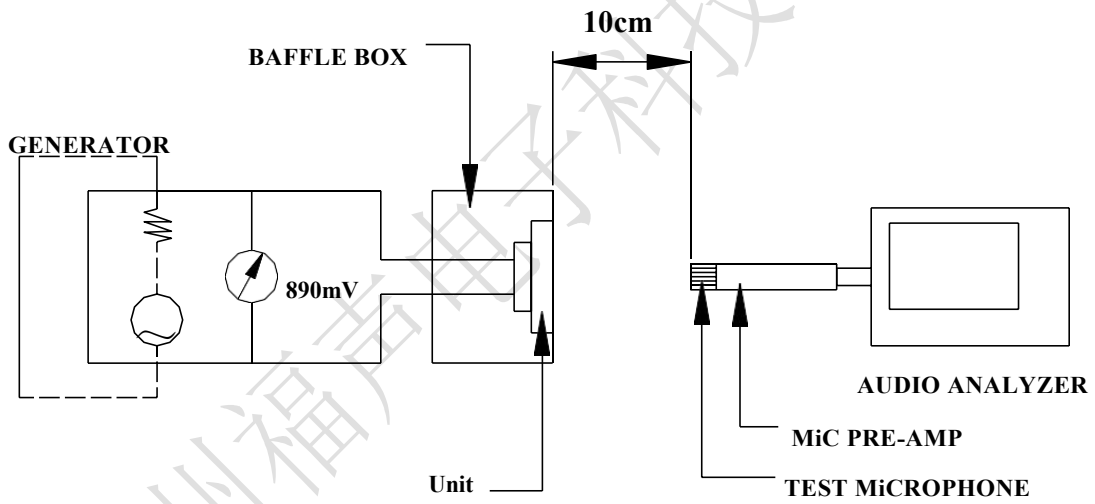
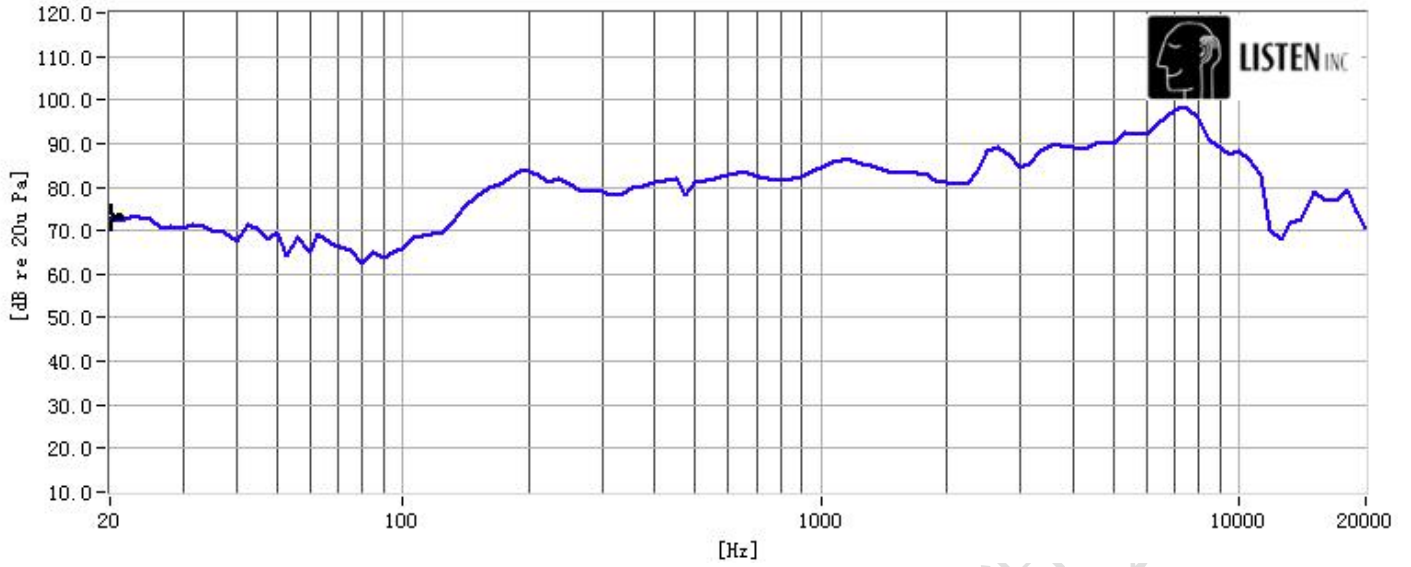

Product Outside View

