

XC5012 1mA~200mA Linear Li-Ion Battery Charger

GENERAL DESCRIPTION

The XC5012 is a complete constant current & constant voltage linear charger for single cell lithium-ion batteries. Its SOT package and low external component count make the XC5012 ideally suited for portable applications. Furthermore, the XC5012 is specifically designed to work within USB power specifications.

No external sense resistor is needed, and no blocking diode is required due to the internal MOSFET architecture. Thermal feedback regulates the charge current to limit the die temperature during high power operation or high ambient temperature. The charge voltage is fixed at 4.35V, and the charge current can be programmed externally with a single resistor. The XC5012 automatically terminates the charge cycle when the charge current drops to 1/10th the programmed value after the final float voltage is reached.

When the input supply (wall adapter or USB supply) is removed, the XC5012 automatically enters a low current state, dropping the battery drain current to less than 2uA. The XC5012 can be put into shutdown mode, reducing the supply current to 50uA.

Other features include under-voltage lockout, automatic recharge and one status pin to indicate charge and charge termination.

FEATURES

- Programmable Charge Current Up to 200mA
- No MOSFET, Sense Resistor or Blocking Diode Required
- Complete Linear Charger in SOT Package for single Cell Lithium-Ion Batteries
- Constant-Current/Constant-Voltage Operation with Thermal Regulation to Maximize Charge Rate Without Risk of Overheating
- Charges Single Cell Li-Ion Batteries Directly from USB Port
- Preset 4.35V Charge Voltage with $\pm 1\%$ Accuracy
- Charge Current Monitor Output for Gas Gauging
- Automatic Recharge
- C/10 Charge Termination
- 50uA Supply Current in Shutdown
- 2.9V Trickle Charge Threshold
- Soft-Start Limits Inrush Current
- ESD HBM 8KV
- Available in SOT23-5 Package

APPLICATIONS

- Wearable device
- Small capacity battery charger application
- Bluetooth 、 GPS Applications

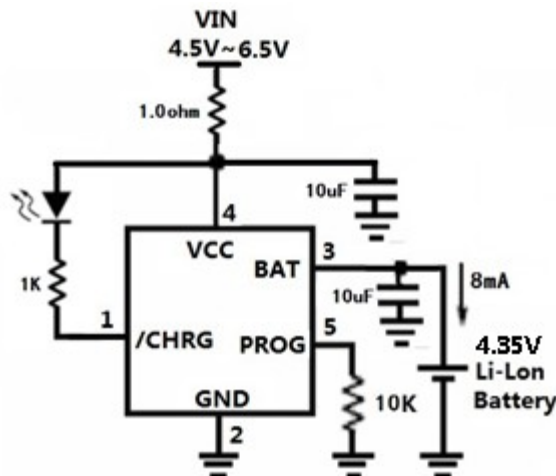

Figure1 . Typical Application Circuit

ORDERING INFORMATION

PART NUMBER	TEMP RANGE	VIN	VBAT	CHARGE CURRENT	PACKAGE	PINS
XC5012	-40°C to 85°C	4.5~6V	4.35V	1mA~200mA	SOT23	5

PIN CONFIGURATION

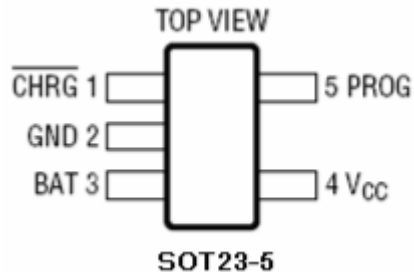

Figure 2. PIN Configuration

PIN DESCRIPTION

PIN NUMBER	PIN NAME	PIN DESCRIPTION
1,	/CHRG	Open-Drain Charge Status Output.
2	GND	Ground
3	BAT	Charge Current Output.
4	VCC	Positive Input Supply Voltage.
5	PROG	Charge Current Program, Charge Current Monitor and Shutdown Pin.

ABSOLUTE MAXIMUM RATINGS

(Note: Do not exceed these limits to prevent damage to the device. Exposure to absolute maximum rating conditions for long periods may affect device reliability.)

PARAMETER	VALUE	UNIT
Input Supply Voltage VCC	VSS-0.3 ~ VSS+7	V
PROG pin Voltage Vprog	VSS-0.3 ~ Vcc+0.3	V
BAT pin Voltage Vbat	Vss-0.3 ~ 7	V

CHAG pin Voltage Vchrg	VSS-0.3 ~ VSS+7	V
BAT pin Current Ibat	0.25	A
PROG pin Current Iprog	2.5	mA
Operating Ambient Temperature	-40 to 85	°C
Maximum Junction Temperature	150	°C
Storage Temperature	-55 to 150	°C
Lead Temperature (Soldering, 10 sec)	260	°C

ELECTRICAL CHARACTERISTICS

(V_{CC} = 5.0V, V_{bat}=3.5V T_A= 25°C unless otherwise specified)

PARAMETER	SYMBOL	TEST CONDITIONS	MIN	TYP	MAX	UNIT
Input Voltage Range	VCC		4.5		6.5	V
Input supply current	I _{cc}	Charge mode, R _{PROG} =1K		350	2000	uA
		Standby mode		150	500	uA
		Shutdown mode(R _{PROG} not connected, V _{cc} <V _{bat} or V _{cc} <V _{uv})		50	100	uA
BAT pin Current	I _{bat}	R _{PROG} =1k, Current mode	79	88	97	mA
		R _{PROG} =2k, Current mode	39	44	49	mA
		R _{PROG} =10k, Current mode	7	8	9	mA
		Standby mode, V _{bat} =4.35V	0	-2.5	-6	uA
		Shutdown mode		1	2.5	uA
		Sleep mode, V _{cc} =0V		0.3	2.5	uA
Regulated Charge Voltage	V _{float}	0°C ≤ T _A ≤ 85°C, I _{charge} = 4mA	4.305	4.35	4.395	V
PROG pin Voltage	V _{prog}	R _{PROG} =10k, Current mode	0.93	1.0	1.07	V
Trickle charge current	I _{trikl}	V _{bat} <V _{trikl} , R _{prog} =2k	3	4	5	mA
Trickle charge Threshold Voltage	V _{trikl}	R _{PROG} =10K , V _{bat} Rising	2.8	2.9	3.0	V
Trickle voltage hysteresis voltage	V _{trhys}	R _{PROG} =10K	60	80	110	mV
Recharge Battery threshold Voltage	ΔV _{recg}	V _{FLOAT} - V _{RECHRG}		150	300	mV
CHRG pin Output low voltage	V _{chrg}	I _{chrg} =5mA		0.35	0.6	V

PIN FUNCTION

CHRG (PIN 1): Open-Drain Charge Status Output.

When the battery is charging, the CHRG pin is pulled low by an internal N-channel MOSFET. When the charge cycle is completed, CHRG pin will be in a high-impedance state.

GND (PIN 2): Ground.

BAT (PIN 3): Charge Current Output.

Provides charge current to the battery and regulates the final float voltage to 4.35V. An internal precision resistor divider from this pin sets the float voltage which is disconnected in shutdown mode.

VCC (PIN 4): Positive Input Supply Voltage.

Provides power to the charger, VCC can range from 4.5V to 6.5V and should be bypassed with at least a 10uF capacitor. When VCC drops to within 30mV of the BAT pin voltage, the XC5012 enters shutdown mode, dropping IBAT to less than 2uA.

PROG (PIN 5): Charge Current Program, Charge Current Monitor and Shutdown Pin.

The charge current is programmed by connecting a 1% resistor, RPROG, to ground. When charging in constant-current mode, this pin serves to 1V. In all modes, the voltage on this pin can be used to measure the charge current using the following formula:

$$IBAT = (VPROG/RPROG) \times 88.$$

The PROG pin can also be used to shut down the charger. Disconnecting the program resistor from ground allows a 0.05uA current to pull the PROG pin high. When it reaches the 1.21V shutdown threshold voltage, the charger enters shutdown mode, charging stops and the input supply current drops to 50uA. This pin is also clamped to approximately 2.4V. Driving this pin to voltages beyond the clamp voltage will draw currents as high as 1.5mA. Reconnecting RPROG to ground will return the charger to normal operation.

TYPICAL PERFORMANCE CHARACTERISTICS

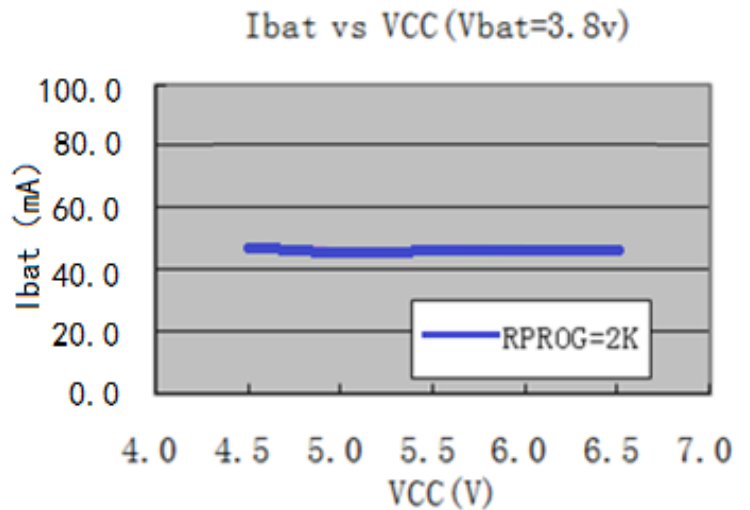
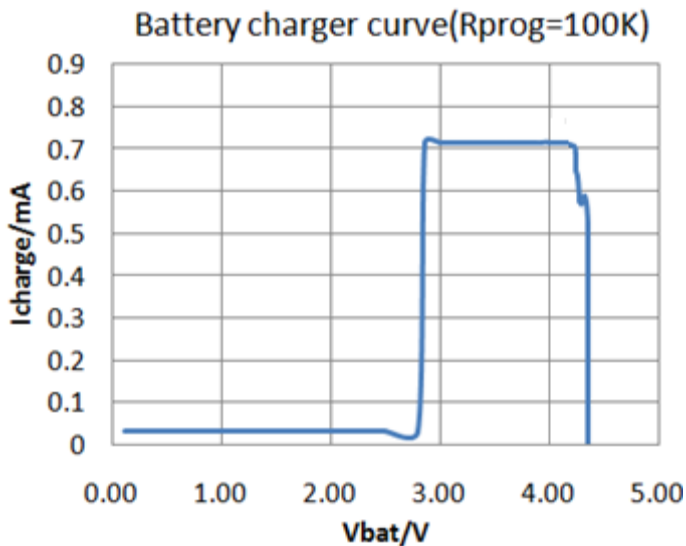
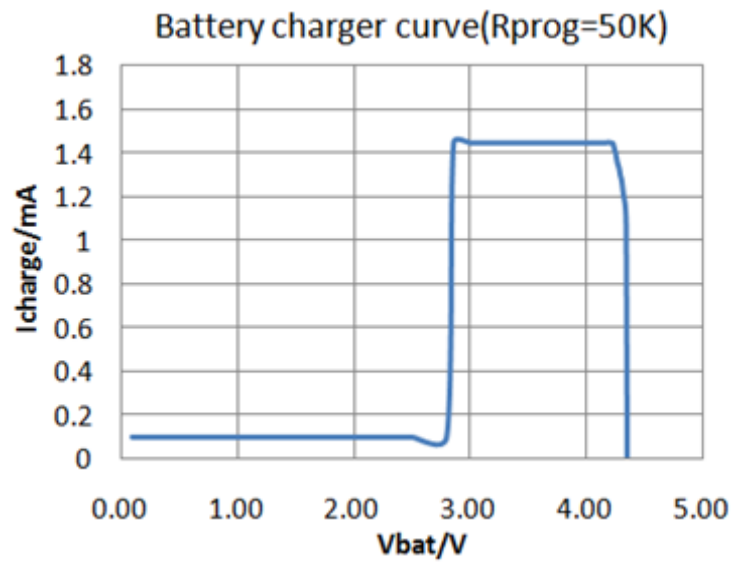
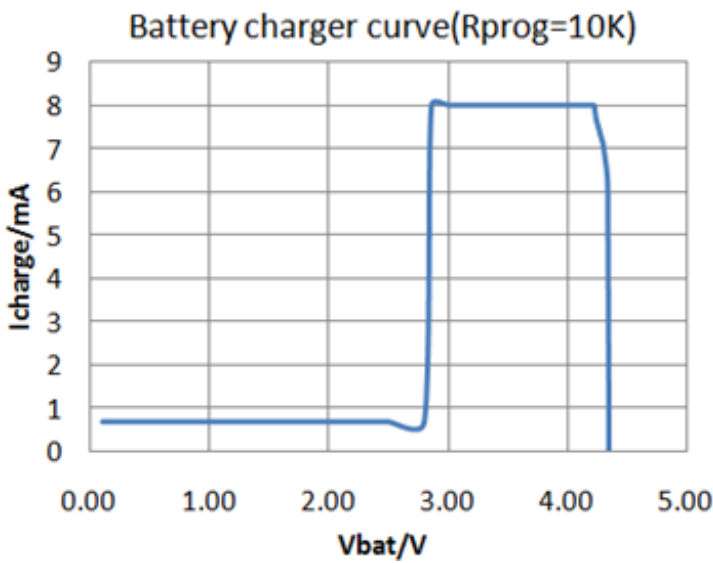
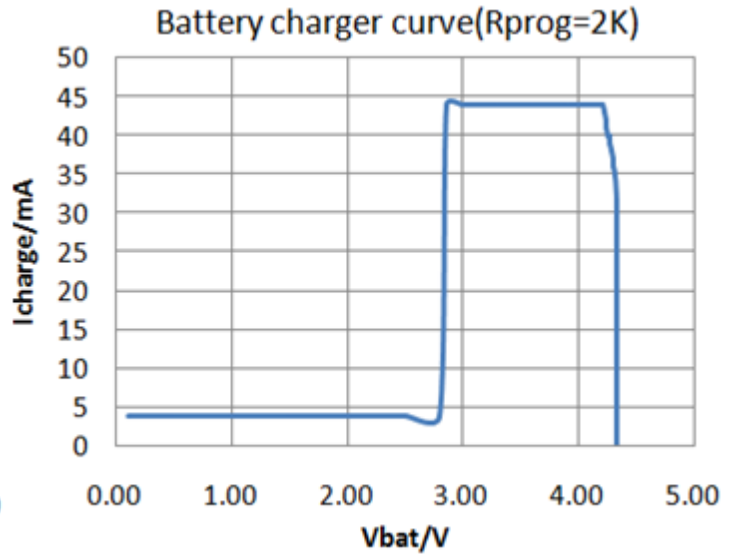
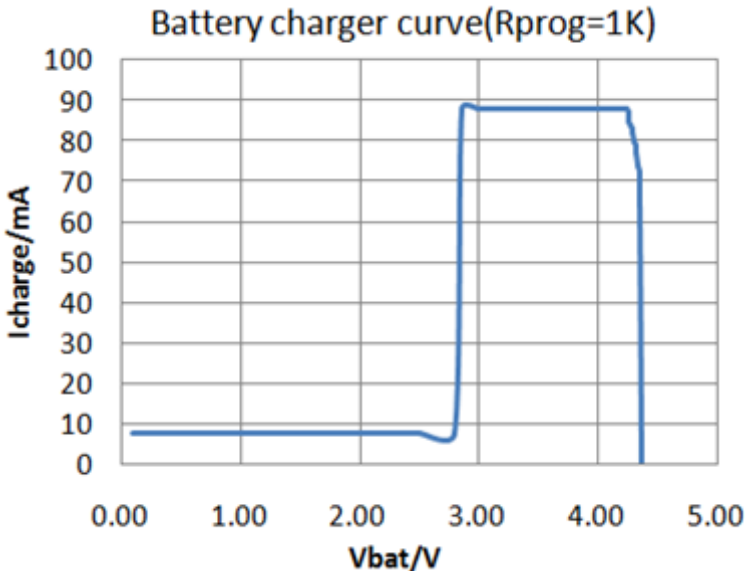

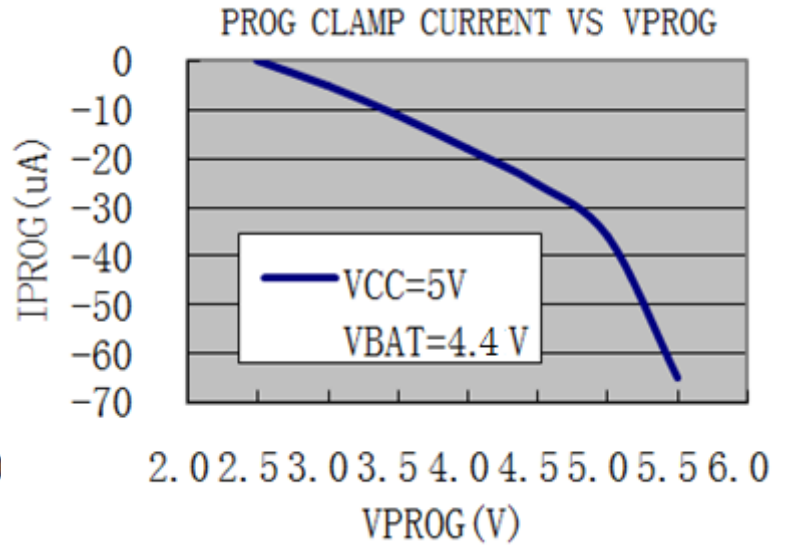
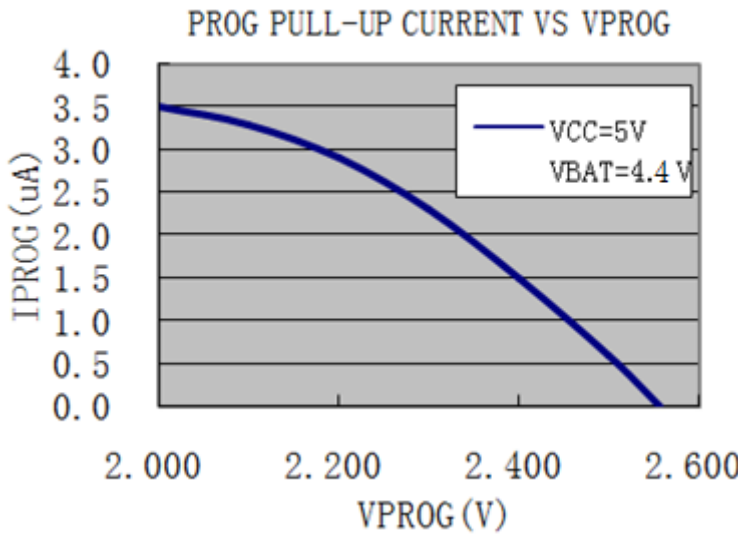
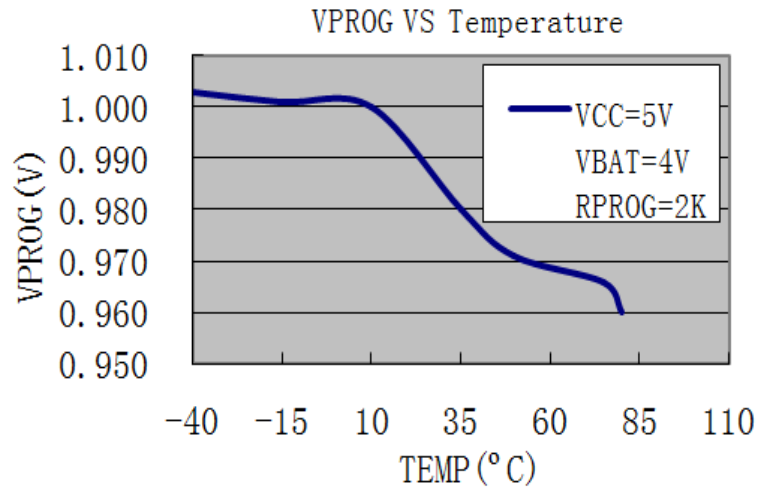
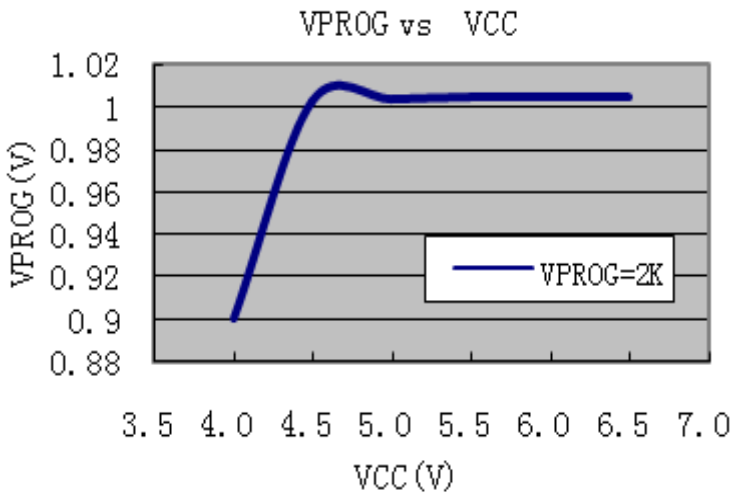

PACKAGE OUTLINE

SOT23-5 PACKAGE OUTLINE AND DIMENSIONS

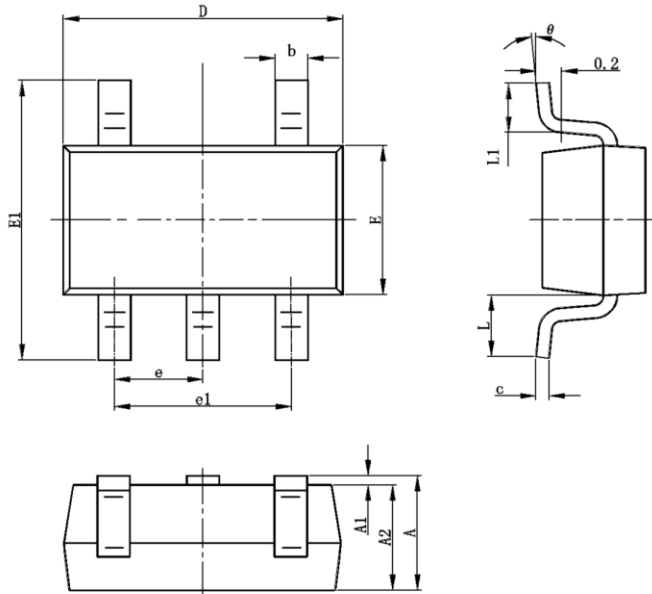

SYMBOL	DIMENSION IN MILIMETERS		DIMENSION IN INCHES	
	MIN	MAX	MIN	MAX
A	1.050	1.250	0.041	0.049
A1	0.000	0.100	0.000	0.004
A2	1.050	1.150	0.041	0.045
b	0.300	0.400	0.012	0.016
c	0.100	0.200	0.004	0.008
D	2.820	3.020	0.111	0.119
E	1.500	1.700	0.059	0.067
E1	2.650	2.950	0.104	0.116
e	0.950 TYP		0.037 TYP	
e1	1.800	2.000	0.071	0.079
L	0.700 REF		0.028 REF	
L1	0.300	0.600	0.012	0.024
θ	0°	8°	0°	8°