

1W Isolated DC-DC converter
Fixed input voltage, unregulated dual output



Continuous Short
Circuit Protection

UL **CE** **CB** Patent Protection **RoHS**



FEATURES

- Continuous short-circuit protection
- No-load input current as low as 8mA
- Operating ambient temperature range: -40°C to +105°C
- High efficiency up to 85%
- Compact SMD package
- I/O isolation test voltage: 1.5k VDC
- Industry standard pin-out
- IEC62368, UL62368, EN62368 approved

A_XT-1WR3 series are specially designed for applications where two isolated voltage is required in a distributed power supply system. They are suitable for: pure digital circuits, low frequency analog circuits, relay-driven circuits and data switching circuits.

Selection Guide

Certification	Part No.	Input Voltage (VDC)	Output		Full Load Efficiency (%) Min./Typ.	Capacitive Load(μF) Max.*
		Nominal (Range)	Voltage (VDC)	Current (mA) Max./Min.		
UL/CE/CB	A1205XT-1WR3	12 (10.8-13.2)	±5	±100/±10	78/82	1200
--	A12Y7XT-1WR3		±7.5	±67/±7	78/82	470
UL/CE/CB	A1209XT-1WR3		±9	±56/±6	79/83	470
	A1212XT-1WR3		±12	±42/±5	79/83	220
	A1215XT-1WR3		±15	±34/±4	79/83	220
	A1224XT-1WR3	±24	±21/±3	81/85	100	
	A1515XT-1WR3	15 (13.5-16.5)	±15	±34/±4	79/83	220
UL/CE/CB	A2405XT-1WR3	24 (21.6-26.4)	±5	±100/±10	76/82	1200
	A2409XT-1WR3		±9	±56/±6	77/83	470
	A2412XT-1WR3		±12	±42/±5	77/83	220
	A2415XT-1WR3		±15	±34/±4	77/83	220
	A2424XT-1WR3		±24	±21/±3	79/85	100

Note: * The specified maximum capacitive load for positive and negative output is identical.

Input Specifications

Item	Operating Conditions		Min.	Typ.	Max.	Unit
Input Current (full load / no-load)	12V input	±5VDC/±7.5VDC output	--	102/8	107/--	mA
		±9VDC/±12VDC/±15VDC output	--	101/8	106/--	
		±24VDC output	--	99/8	103/--	
	15V input		--	81/8	85/--	
	24V input	±5VDC/±9VDC/±12VDC/±15VDC output	--	51/8	55/--	
±24VDC output		--	50/8	53/--		
Reflected Ripple Current*			--	15	--	
Surge Voltage(1sec. max.)	12VDC input		-0.7	--	18	VDC
	15VDC input		-0.7	--	21	
	24VDC input		-0.7	--	30	
Input Filter			Capacitance filter			
Hot Plug			Unavailable			

Note: * Reflected ripple current testing method please see DC-DC Converter Application Notes for specific operation.

Output Specifications

Item	Operating Conditions	Min.	Typ.	Max.	Unit	
Voltage Accuracy		See output regulation curves (Fig. 1)				
Linear Regulation	Input voltage change: $\pm 1\%$	--	--	1.2	--	
Load Regulation	10%-100% load	$\pm 5\text{VDC}$ output	--	5	15	%
		$\pm 7.5\text{VDC}$ output	--	5	15	
		$\pm 9\text{VDC}$ output	--	3	10	
		$\pm 12\text{VDC}$ output	--	3	10	
		$\pm 15\text{VDC}$ output	--	3	10	
		$\pm 24\text{VDC}$ output	--	2	10	
Ripple & Noise*	20MHz bandwidth	$\pm 5\text{VDC}/\pm 7.5\text{VDC}/\pm 9\text{VDC}/$ $\pm 12\text{VDC}/\pm 15\text{VDC}$ output	--	30	75	mVp-p
		$\pm 24\text{VDC}$ output	--	50	100	
			--			
Temperature Coefficient	Full load	--	± 0.02	--	$\%/^{\circ}\text{C}$	
Short-Circuit Protection		Continuous, self-recovery				

Note: * The "parallel cable" method is used for ripple and noise test, please refer to *DC-DC Converter Application Notes* for specific information.

General Specifications

Item	Operating Conditions	Min.	Typ.	Max.	Unit
Isolation	Input-output electric strength test for 1 minute with a leakage current of 1mA max.	1500	--	--	VDC
Insulation Resistance	Input-output resistance at 500VDC	1000	--	--	$\text{M}\Omega$
Isolation Capacitance	Input-output capacitance at 100kHz/0.1V	--	20	--	pF
Operating Temperature	Derating when operating temperature $\geq 100^{\circ}\text{C}$, (see Fig. 2)	-40	--	105	$^{\circ}\text{C}$
Storage Temperature		-55	--	125	
Case Temperature Rise	$T_a=25^{\circ}\text{C}$	--	25	--	
Storage Humidity	Non-condensing	5	--	95	%RH
Reflow Soldering Temperature*		Peak temp. $\leq 245^{\circ}\text{C}$, maximum duration time $\leq 60\text{s}$ over 217°C			
Vibration		10-150Hz, 5G, 0.75mm. along X, Y and Z			
Switching Frequency	Full load, nominal input voltage	--	260	--	kHz
MTBF	MIL-HDBK-217F@ 25°C	3500	--	--	k hours
Moisture Sensitivity Level (MSL)	IPC/JEDEC J-STD-020D.1	Level 1			

Note: * For actual application, please refer to IPC/JEDEC J-STD-020D.1.

Mechanical Specifications

Case Material	Black plastic; flame-retardant and heat-resistant (UL94 V-0)
Dimensions	15.24 x 11.40 x 7.25 mm
Weight	1.4g(Typ.)
Cooling Method	Free air convection

Electromagnetic Compatibility (EMC)

Emissions	CE	CISPR32/EN55032 CLASS B
	RE	CISPR32/EN55032 CLASS B
Immunity	ESD	IEC/EN61000-4-2 Air $\pm 8\text{kV}$, Contact $\pm 6\text{kV}$ perf. Criteria B

Note: Refer to Fig.4 for recommended circuit test.

Typical Performance Curves

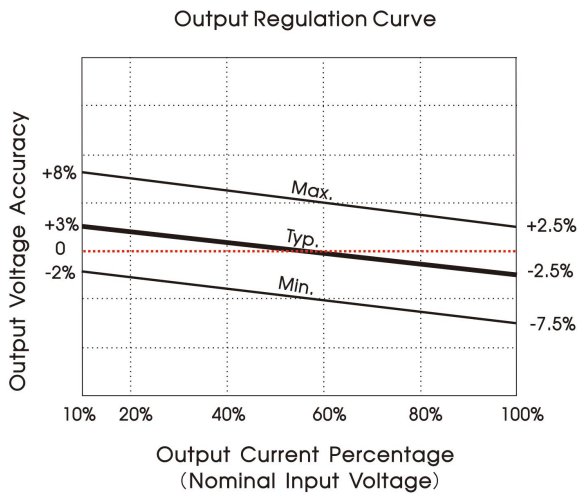

Fig. 1

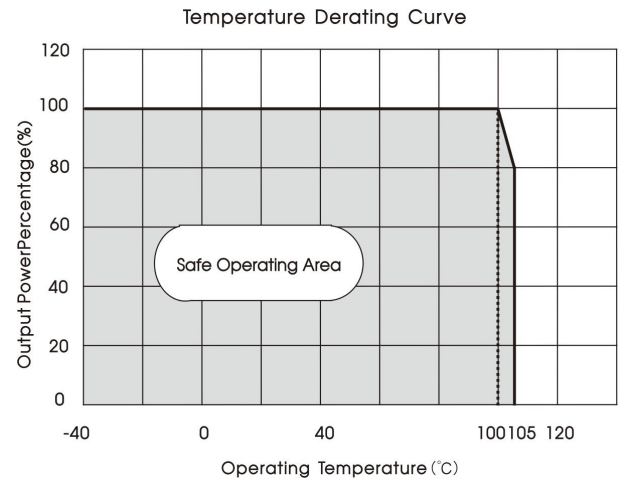
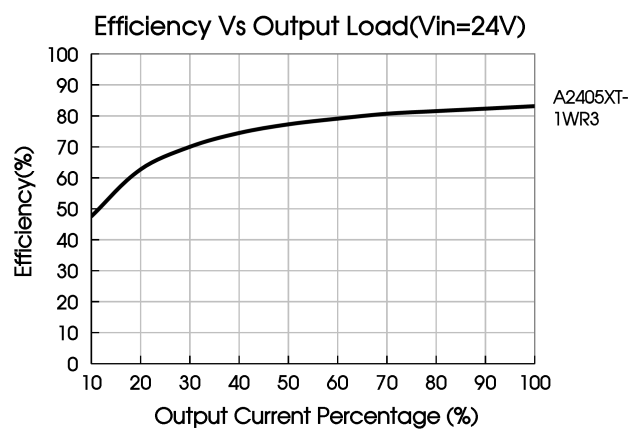
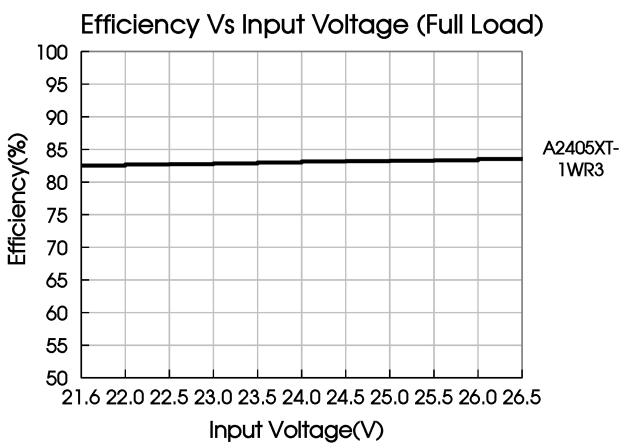
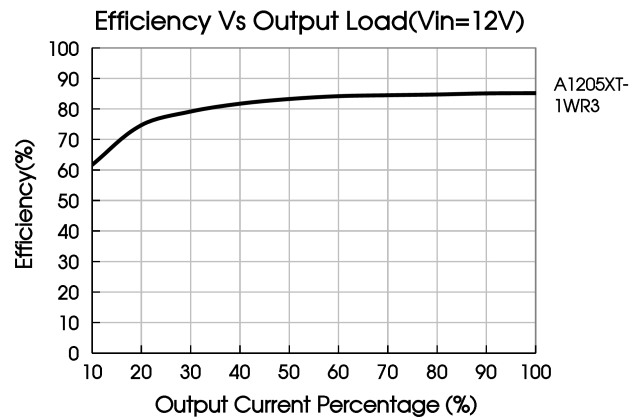
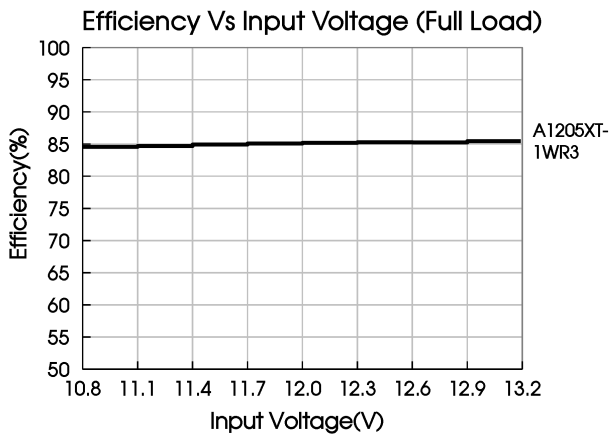

Fig. 2



Design Reference

1. Typical application

Input and/or output ripple can be further reduced, by connecting a filter capacitor from the input and/or output terminals to ground as shown in Fig.3.

Choosing suitable filter capacitor values is very important for a smooth operation of the modules, particularly to avoid start-up problems caused by capacitor values that are too high. For recommended input and output capacitor values refer to Table 1.



Fig.3

Table 1: Recommended input and output capacitor values

Vin	Cin	Vo	Cout
12VDC	2.2μF/25V	±5VDC	4.7μF/16V
15VDC	2.2μF/25V	±7.5VDC	1μF/16V
24VDC	1μF/50V	±9VDC	1μF/16V
--	--	±12VDC	1μF/25V
--	--	±15VDC	0.47μF/25V
--	--	±24VDC	0.47μF/50V

2. EMC compliance circuit

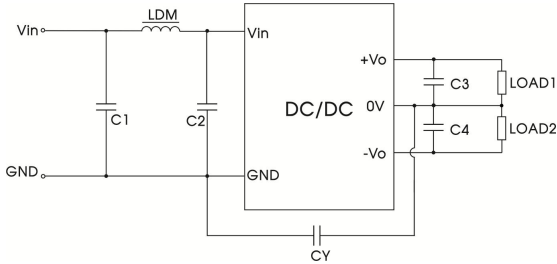

Fig.4

Table 2: EMC recommended circuit value table

Emissions	Component	Value
	C1	4.7μF/50V
	C2	4.7μF/50V
	CY	270pF/2kV
	C3	Refer to the Cout in table 1
	C4	Refer to the Cout in table 1
	LDM	6.8μH

3. For additional information, please refer to DC-DC converter application notes on www.mornsun-power.com

Dimensions and Recommended Layout

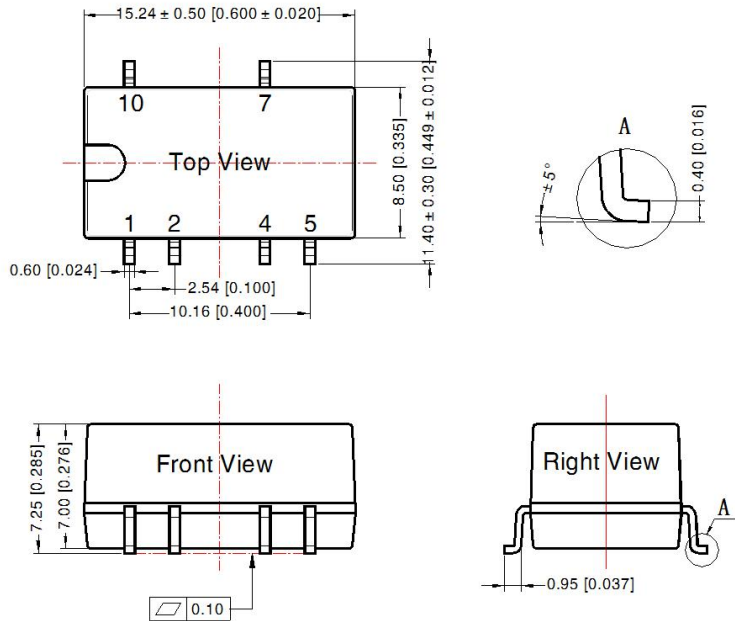

Note:
Unit: mm[inch]
Pin section tolerances: ± 0.10[± 0.004]
General tolerances: ± 0.25[± 0.010]

THIRD ANGLE PROJECTION

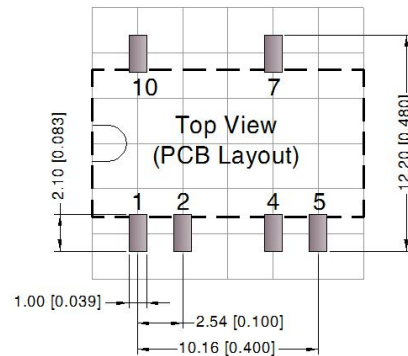

Note: Grid 2.54*2.54mm

Pin-Out	
Pin	Mark
1	GND
2	Vin
4	0V
5	-Vo
7	+Vo
10	NC

NC: Pin to be isolated from circuitry

Tape and Reel Info

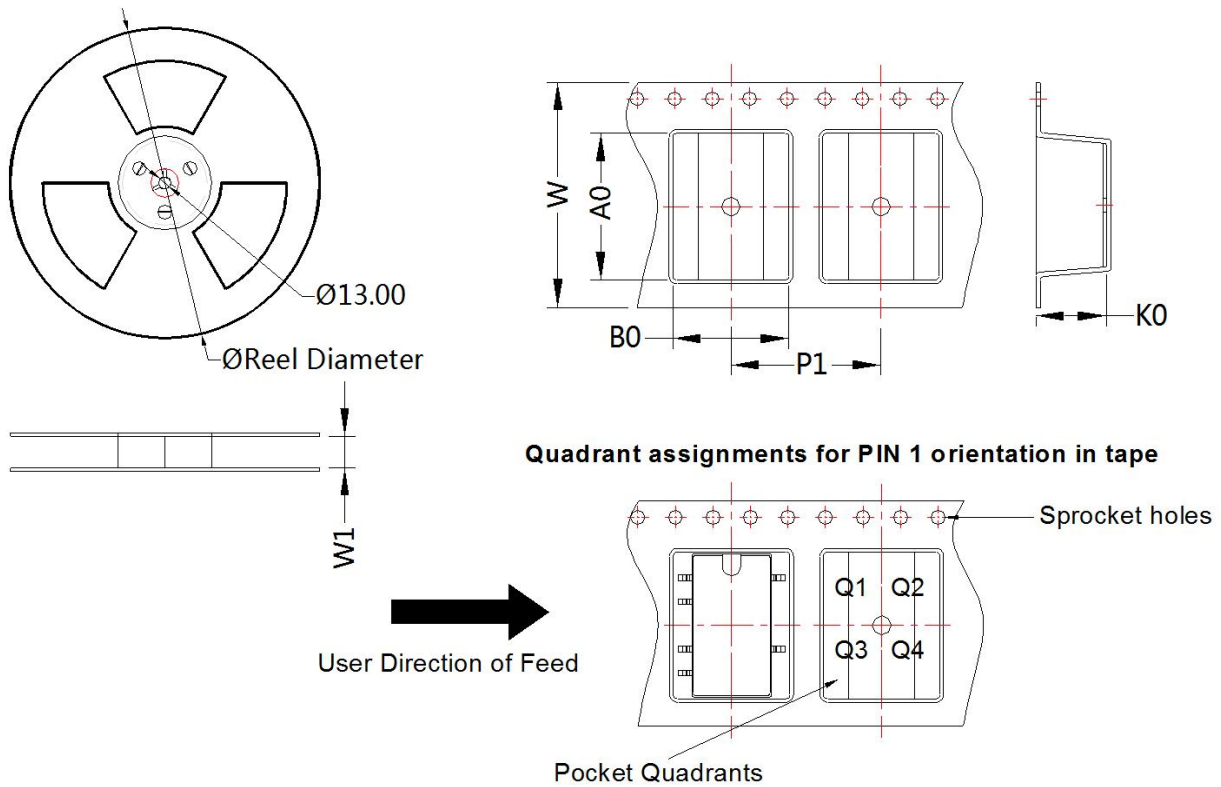

Device	Package Type	Pin	SPQ	Reel Diameter (mm)	Reel Width W1 (mm)	A0 (mm)	B0 (mm)	K0 (mm)	P1 (mm)	W (mm)	Pin1 Quadrant
A_XT-1WR3	SMD	6	500	330.0	24.5	15.64	12.4	7.45	16.0	24.0	Q1

Notes:

1. For additional information on Product Packaging please refer to www.mornsun-power.com. Tube Packaging bag number: 58210023, Roll Packaging bag number: 58210034;
2. If the product is not operated within the required load range, the product performance cannot be guaranteed to comply with all parameters in the datasheet;
3. The maximum capacitive load offered were tested at input voltage range and full load;
4. Unless otherwise specified, parameters in this datasheet were measured under the conditions of Ta=25°C, humidity<75%RH with nominal input voltage and rated output load;
5. All index testing methods in this datasheet are based on our company corporate standards;
6. We can provide product customization service, please contact our technicians directly for specific information;
7. Products are related to laws and regulations: see "Features" and "EMC";
8. Our products shall be classified according to ISO14001 and related environmental laws and regulations, and shall be handled by qualified units.

MORNSUN Guangzhou Science & Technology Co., Ltd.

Address: No. 5, Kehui St. 1, Kehui Development Center, Science Ave., Guangzhou Science City, Huangpu District, Guangzhou, P. R. China
 Tel: 86-20-38601850 Fax: 86-20-38601272 E-mail: info@mornsun.cn www.mornsun-power.com