

Y TSA016C0254004B

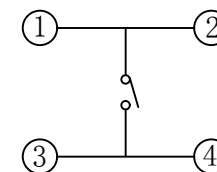

电路图
CIRCUIT DIAGRAM

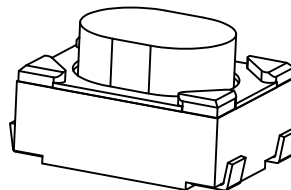
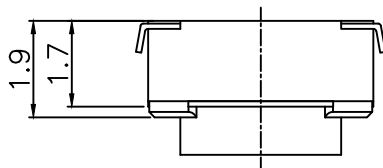
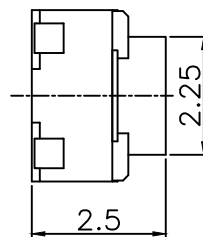
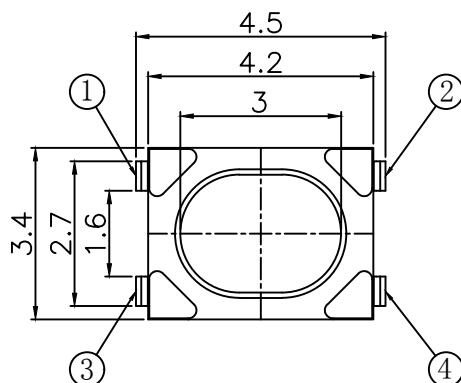
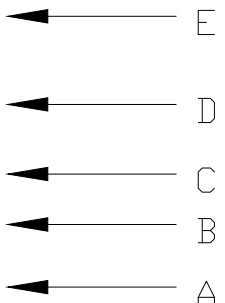
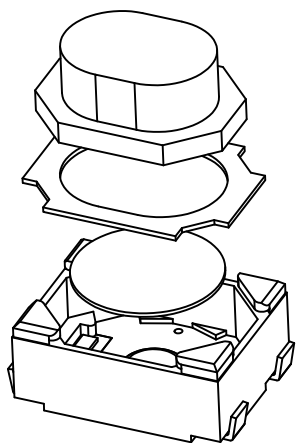
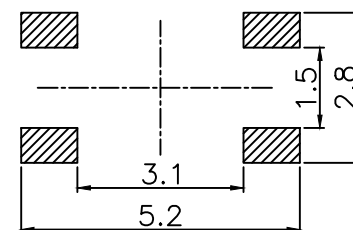

PCB. 焊接图
PCB. WELDING DRAWING

主要技术参数、性能

The Main Thchnology Performance

额定电流、电压 Rate voltage, current	50mA DC12V
接触电阻 Contact resistance	≤100mΩ
按力 Operating force	400±50gf
行程 travel	0.20±0.10mm
绝缘电阻 Insulated resistance	≥100MΩ
介电强度 Dielectric strength	≥250VAC/1min
寿命 Endurance	≥50000次

E	按钮	PPA	1	黑色
D	盖板	磷铜	1	镀铜锡
C	弹片	不锈钢	2	镀银
B	本体	LCP	1	白色
A	卡件	磷铜	1	镀银
项目 ITEM	名称 DESCRIPTION	材质 MATERIAL	数量 QTY	表面处理/颜色 FINISH/COLOR

					第一视角 FIRST VIEW		名称/NAME: 轻触开关 TACTILE SWITCH	
							型号/MODEL: Y TSA016C0254004B	
标记 SING	处数 FREQUENCY	更改文件号 REVISION	签名 APPROVED	日期 DATE	比例 SCALE	1:1	一般公差 GENERAL TOLERANCE	
设计 DESIGN	赵晓峰		2017.05.17		单位 UNIT	mm	0.5~2	±0.10
审核 CHECKED	陈乐峰		2017.05.17		重量 WEIGHT		2~5	±0.15
批准 APPROVED	朱旭静		2017.05.17				5~10	±0.20
							角度 ANGLE	±0.5°

名称/NAME:
轻触开关
TACTILE SWITCH

型号/MODEL:
Y TSA016C0254004B

博众电气 东莞博众电气有限公司
DONGGUAN BOZHONG ELECTRONIC CO., LTD.