

MSKSEMI

SEMICONDUCTOR



ESD



TVS



TSS



MOV



GDT



PLED

Product data sheet

Features

- Ultra-Low capacitance:0.35pF(typ.)
- Reverse stand-off voltage:5V
- IEC 61000-4-2 (Air): ±15KV
IEC 61000-4-2 (Contact): ±10KV

Pin Description



Applications

- USB 3.0, USB 2.0
- HDMI 1.3/1.4, Display Port 1.3, eSATA
- Unified Display Interface (UDI)
- Digital Visual Interface (DVI)
- High speed serial interfaces

Schematic Diagram

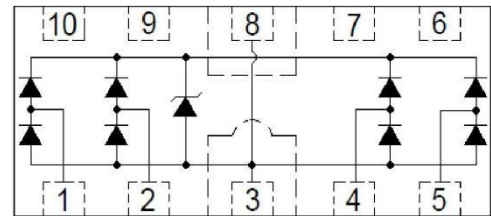

Top View

Limiting Values(T_A = 25 °C, unless otherwise specified)

Symbol	Parameter	Conditions	Min	Max	Unit
V _{ESD}	Electrostatic Discharge Voltage	IEC 61000-4-2; Contact Discharge	-	±10	kV
		IEC 61000-4-2; Air Discharge	-	±15	kV
I _{PPM}	Rated Peak Pulse Current	t _p = 8/20 μs	-	2.5	A
T _A	Ambient Temperature Range	-	-55	125	°C
T _{stg}	Storage Temperature Range	-	-55	150	°C

Electrical Characteristics(T_A = 25 °C unless otherwise specified)

Symbol	Parameter	Conditions	Min	Typ.	Max	Unit
V _{RWM}	Reverse Working Voltage	T _A = 25 °C	-	-	5	V
V _{BR}	Breakdown Voltage	I _R = 1 mA	6	7.2	9.5	V
I _R	Reverse Leakage Current	V _{RWM} = 5V	-	0.01	1	μA
V _C	Clamping Voltage	I _{PP} =2.5A, T _P =8/20μs	-	10	-	V
		V _{ESD} =+8kV	-	20	-	V
V _T	Trigger Voltage	V _{ESD} =+8kV	-	135	-	V
C _J	Junction Capacitance	V _R = 0V, f = 1 MHz, I/O to I/O	-	0.15	-	pF
		V _R = 0V, f = 1 MHz, I/O to GND	-	0.35	-	pF

Typical Characteristics

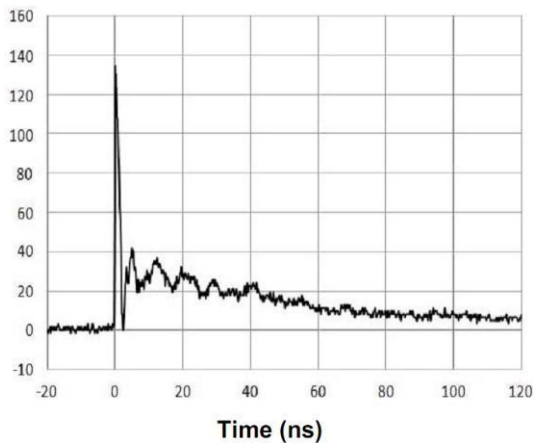

Fig.1 IEC61000-4-2 +8kV Contact ESD Clamping Waveform

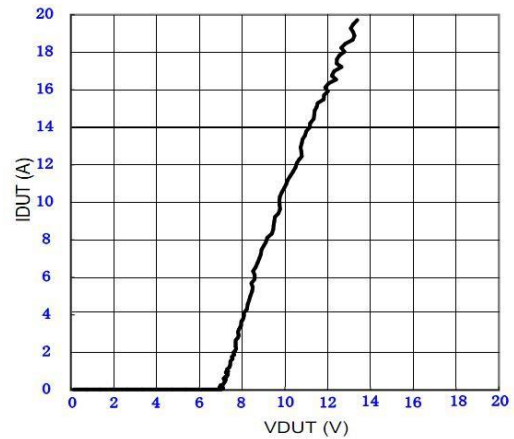

Fig.2 Transmission Line Pulse (t_p=100ns)

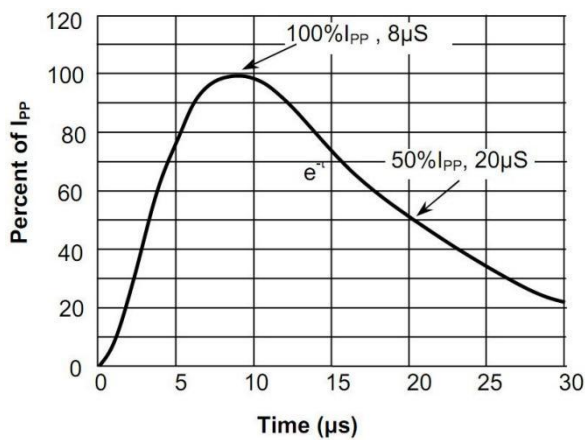

Fig.3 Pulse Waveform-8/20μs

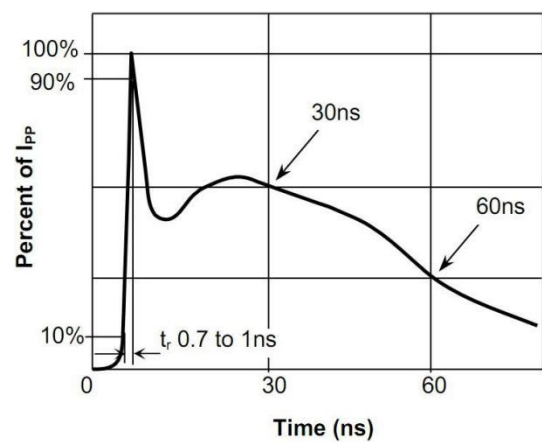
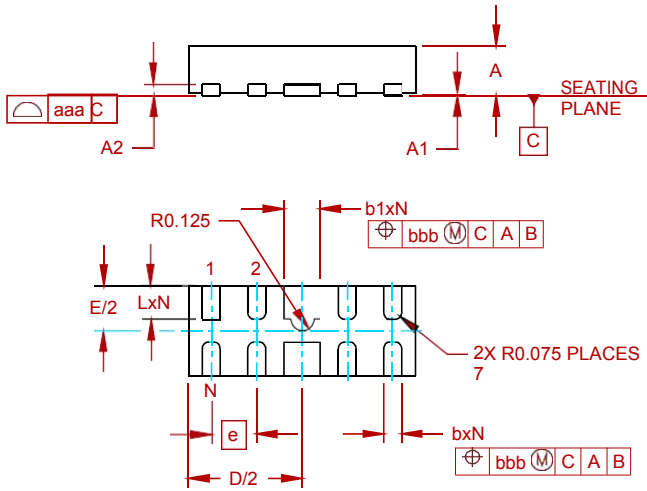
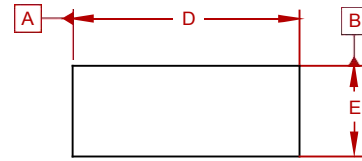

Fig.4 Pulse Waveform-ESD(IEC61000-4-2)

PACKAGE MECHANICAL DATA



Dimensions in millimeters



DIM	INCHES			MILLIMETERS		
	MIN	NOM	MAX	MIN	NOM	MAX
A	.020	.023	.026	0.50	0.58	0.65
A1	0.00	.001	.002	0.00	0.03	0.05
A2	(.005)			(0.13)		
b	.006	.008	.010	0.15	0.20	0.25
b1	.014	.016	.018	0.35	0.40	0.45
D	.094	.098	.102	2.40	2.50	2.60
E	.035	.039	.043	0.90	1.00	1.10
e	.020 BSC			0.50 BSC		
L	.012	.015	.017	0.30	0.38	0.425
N	8			8		
aaa	.003			0.08		
bbb	.004			0.10		

Suggested Pad Layout

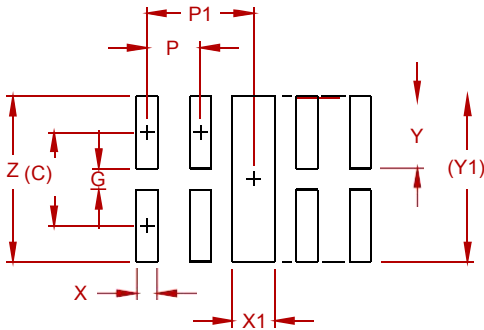

DIM	DIMENSIONS	
	INCHES	MILLIMETERS
C	(.034)	(0.875)
G	.008	0.20
P	.020	0.50
P1	.039	1.00
X	.008	0.20
X1	.016	0.40
Y	.027	0.675
Y1	(.061)	(1.55)
Z	.061	1.55

NOTES:

CONTROLLING DIMENSIONS ARE IN MILLIMETERS (ANGLES IN DEGREES).
THIS LAND PATTERN IS FOR REFERENCE PURPOSES ONLY.
CONSULT YOUR MANUFACTURING GROUP TO ENSURE YOUR COMPANY'S MANUFACTURING GUIDELINES ARE MET.

REEL SPECIFICATION

P/N	PKG	QTY
PESDALC10N5VU-MS	DFN-10	3000

Attention

- Any and all MSKSEMI Semiconductor products described or contained herein do not have specifications that can handle applications that require extremely high levels of reliability, such as life-support systems, aircraft's control systems, or other applications whose failure can be reasonably expected to result in serious physical and/or material damage. Consult with your MSKSEMI Semiconductor representative nearest you before using any MSKSEMI Semiconductor products described or contained herein in such applications.
- MSKSEMI Semiconductor assumes no responsibility for equipment failures that result from using products at values that exceed, even momentarily, rated values (such as maximum ratings, operating condition ranges, or other parameters) listed in products specifications of any and all MSKSEMI Semiconductor products described or contained herein.
- Specifications of any and all MSKSEMI Semiconductor products described or contained herein stipulate the performance, characteristics, and functions of the described products in the independent state, and are not guarantees of the performance, characteristics, and functions of the described products as mounted in the customer's products or equipment. To verify symptoms and states that cannot be evaluated in an independent device, the customer should always evaluate and test devices mounted in the customer's products or equipment.
- MSKSEMI Semiconductor strives to supply high-quality high-reliability products. However, any and all semiconductor products fail with some probability. It is possible that these probabilistic failures could give rise to accidents or events that could endanger human lives, that could give rise to smoke or fire, or that could cause damage to other property. When designing equipment, adopt safety measures so that these kinds of accidents or events cannot occur. Such measures include but are not limited to protective circuits and error prevention circuits for safe design, redundant design, and structural design.
- In the event that any or all MSKSEMI Semiconductor products (including technical data, services) described or contained herein are controlled under any of applicable local export control laws and regulations, such products must not be exported without obtaining the export license from the authorities concerned in accordance with the above law.
- No part of this publication may be reproduced or transmitted in any form or by any means, electronic or mechanical, including photocopying and recording, or any information storage or retrieval system, or otherwise, without the prior written permission of MSKSEMI Semiconductor.
- Information (including circuit diagrams and circuit parameters) herein is for example only ; it is not guaranteed for volume production. MSKSEMI Semiconductor believes information herein is accurate and reliable, but no guarantees are made or implied regarding its use or any infringements of intellectual property rights or other rights of third parties.
- Any and all information described or contained herein are subject to change without notice due to product/technology improvement, etc. When designing equipment, refer to the "Delivery Specification" for the MSKSEMI Semiconductor product that you intend to use.