

Features

- Ultra low leakage: nA level
- Operating voltage: 33V
- Low clamping voltage
- Complies with following standards:
 - IEC 61000-4-2 (ESD) immunity test
 - Air discharge: $\pm 30\text{kV}$
 - Contact discharge: $\pm 30\text{kV}$
 - IEC61000-4-4 (EFT) 40A (5/50ns)
 - IEC61000-4-5 (Lightning) 9.3A (8/20 μs)
- RoHS Compliant

Dimensions SOD-323



Applications

- USB 2.0 power and data line
- Set-top box and digital TV
- Digital video interface (DVI)
- Notebook Computers
- SIM Ports
- 10/100 Ethernet

Pin Configuration

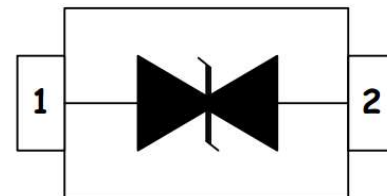

Mechanical Characteristics

- Package: SOD-323
- Lead Finish: Lead Free
- UL Flammability Classification Rating 94V-0
- Quantity Per Reel: 3,000 pcs
- Reel Size: 7 inch

Absolute Maximum Ratings (T_{amb}=25°C unless otherwise specified)

Parameter	Symbol	Value	Unit
Peak Pulse Power (8/20 μs)	P _{pp}	600	W
ESD per IEC 61000-4-2 (Air)	V _{ESD}	± 30	Kv
ESD per IEC 61000-4-2 (Contact)		± 30	
Operating Temperature Range	T _J	-55 to +125	°C
Storage Temperature Range	T _{STJ}	-55 to +150	°C

Electrical Characteristics (TA=25°C unless otherwise specified)

Part Number	Device Marking	V _{RWM} (V)	V _{BR} (V)	I _T (mA)	V _C @1A	V _C		I _R μA (Max)	C (Pf) (Typ.)
						(Max)	(@A)		
SD33CW	30C	33	36.7	1	53.1	71	8.5	1	38

Characteristic Curves

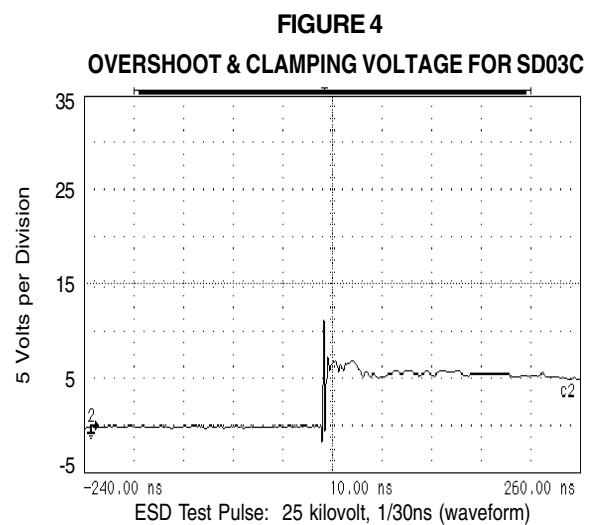
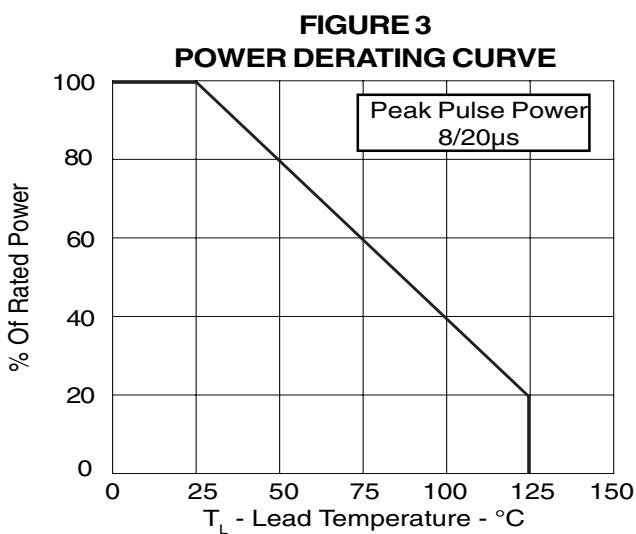
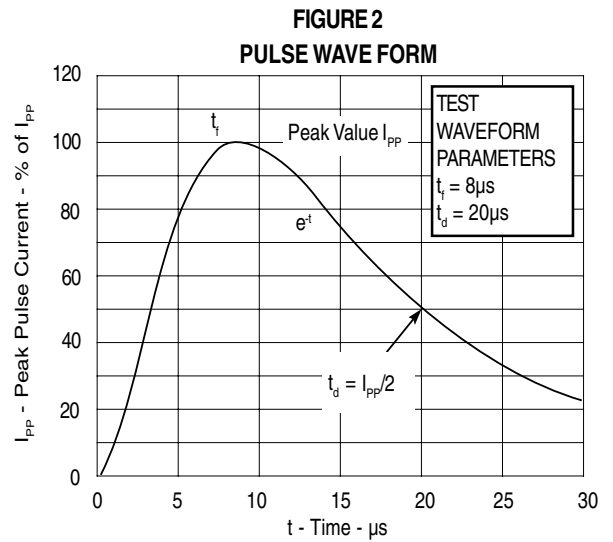
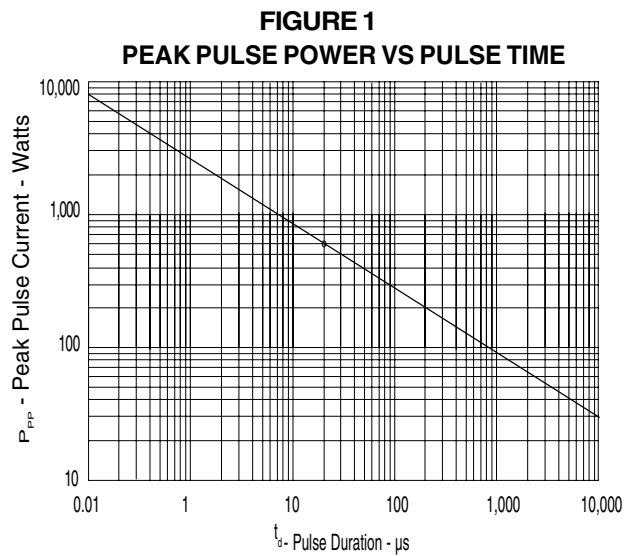

SOD-323 Package Outline & Dimensions

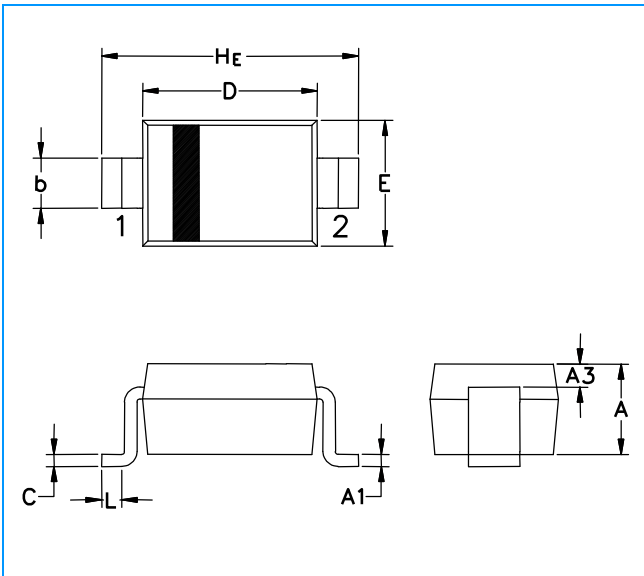

Symbol	Millimeters			Inches		
	Min.	Nom.	Max.	Min.	Nom.	Max.
A	0.80	0.90	1.15	0.031	0.035	0.045
A1	0.001	0.05	0.15	0.004	0.002	0.006
A3	0.15 REF			0.006 REF		
b	0.25	0.32	0.45	0.010	0.012	0.018
C	0.100	0.12	0.150	0.004	0.005	0.006
D	1.60	1.70	1.95	0.063	0.066	0.077
E	1.10	1.25	1.50	0.043	0.049	0.059
L	0.08			0.003		
H_E	2.50	2.50	2.85	0.095	0.098	0.112

Soldering Footprint

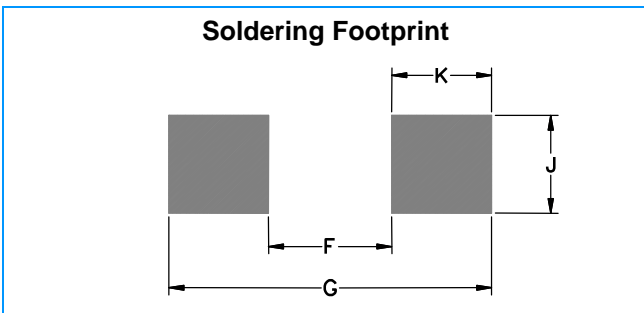

Symbol	Millimeters	Inches
F	1.60	0.063
G	2.20	0.087
J	0.60	0.024
K	0.60	0.024