

Metal Oxide Varistor (MOV) Data Sheet

Features

- Wide operating voltage (V_{1mA}) range from 18V to 1800V
- Fast responding to transient over-voltage
- Large absorbing transient energy capability
- Low clamping ratio and no follow-on current
- Meets MSL level 1, per J-STD-020
- Operating Temperature : $-40^{\circ}\text{C} \sim +105^{\circ}\text{C}$
- Storage Temperature : $-40^{\circ}\text{C} \sim +125^{\circ}\text{C}$
- Safety certification: UL: E327997
CSA: 246579
VDE: 40050493/40005858



Applications

- Transistor, diode, IC, thyristor or triac semiconductor protection
- Surge protection in consumer electronics
- Surge protection in industrial electronics
- Surge protection in electronic home appliances, gas and petroleum appliances
- Relay and electromagnetic valve surge absorption

Part Number Code

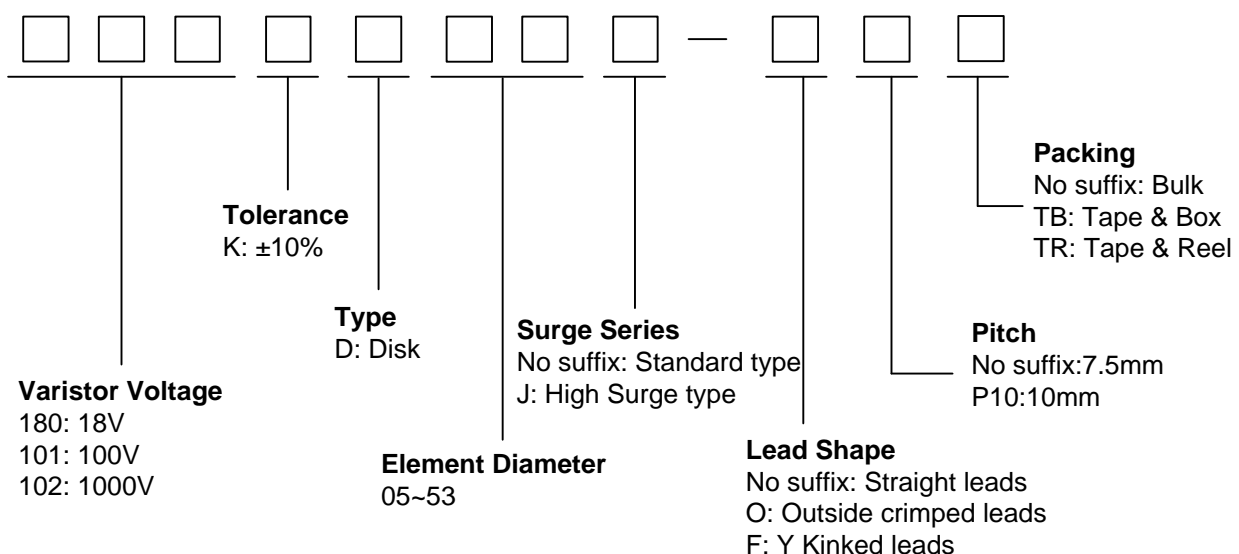

Dimensions

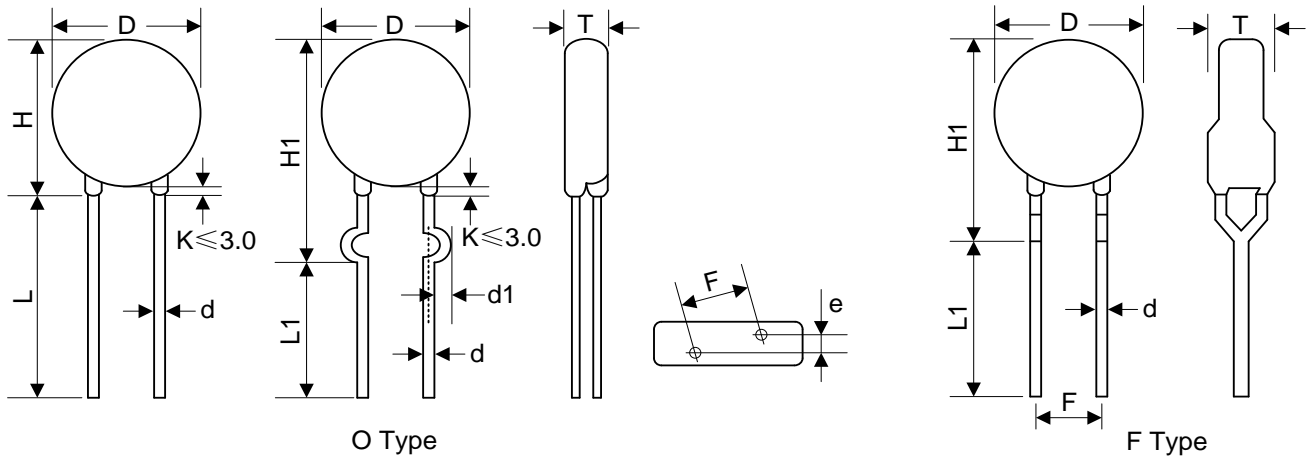

Notes: Varistor voltage ≥ 1200V, structure diagram is F type.

| Table 1 | |
|----------|-----------|
| Unit: mm | |
| Symbol | Dimension |
| H | 14.5~20.0 |
| H1 | 17.0~21.0 |
| L(min.) | 20.0 |
| L1(min.) | 15.0 |
| D | 14.0~16.5 |
| F(±0.8) | 7.5 |
| T | Table 2 |
| e(±0.8) | Table 2 |
| d(±0.05) | 0.8 |
| d1(±0.4) | 1.4 |

| Table 2 | | | | | |
|----------|---------|-----|-------|----------|-----|
| Unit: mm | | | | | |
| Model | T | e | Model | T | e |
| 180K | 2.0~3.9 | 1.5 | 361K | 2.9~5.2 | 2.7 |
| 220K | 2.1~4.0 | 1.6 | 391K | 3.0~5.4 | 2.8 |
| 270K | 2.1~4.1 | 1.8 | 431K | 3.2~5.6 | 3.0 |
| 330K | 2.2~4.3 | 1.7 | 471K | 3.3~5.8 | 3.2 |
| 390K | 2.1~4.1 | 1.8 | 511K | 3.4~6.1 | 3.4 |
| 470K | 2.2~4.3 | 1.9 | 561K | 3.6~6.4 | 3.6 |
| 560K | 2.3~4.6 | 2.1 | 621K | 3.8~6.8 | 3.9 |
| 680K | 2.4~4.8 | 2.4 | 681K | 4.0~7.1 | 4.2 |
| 820K | 2.1~4.1 | 1.8 | 751K | 4.3~7.2 | 4.3 |
| 101K | 2.4~4.2 | 2.0 | 781K | 4.4~7.3 | 4.4 |
| 121K | 2.4~4.4 | 2.2 | 821K | 4.6~7.5 | 4.6 |
| 151K | 2.2~4.1 | 1.8 | 911K | 4.8~7.5 | 5.0 |
| 181K | 2.3~4.2 | 1.9 | 102K | 5.4~8.0 | 5.0 |
| 201K | 2.4~4.3 | 2.0 | 112K | 5.8~8.5 | 5.4 |
| 221K | 2.5~4.4 | 2.1 | 122K | 5.9~9.0 | 5.8 |
| 241K | 2.6~4.5 | 2.2 | 142 | 6.9~10.5 | 6.6 |
| 271K | 2.6~4.6 | 2.4 | 162 | 7.4~11.0 | 7.4 |
| 301K | 2.7~4.6 | 2.5 | 182 | 7.6~12.0 | 8.2 |
| 331K | 2.7~5.0 | 2.5 | | | |

Electrical Characteristics

| Part Number | | Maximum Allowable Voltage | | Varistor Voltage | Maximum Clamping Voltage | | Withstanding Surge Current | | Maximum Energy (10/1000μs) | | Rated Power | Typical Capacitance (Reference) |
|-------------|------------|---------------------------|---------------------|----------------------|--------------------------|--------------------|----------------------------|------------------|----------------------------|----------------|-------------|---------------------------------|
| Standard | High Surge | V _{AC} (V) | V _{DC} (V) | V _{1mA} (V) | I _P (A) | V _C (V) | I (A) Standard | I (A) High Surge | (J) Standard | (J) High Surge | (W) | @1KHz (pf) |
| 180KD14 | 180KD14J | 11 | 14 | 18(15~21.6) | 10 | 36 | 1000 | 2000 | 4.0 | 7.0 | 0.1 | 11100 |
| 220KD14 | 220KD14J | 14 | 18 | 22(19.5~26) | 10 | 43 | 1000 | 2000 | 5.0 | 8.0 | 0.1 | 9100 |
| 270KD14 | 270KD14J | 17 | 22 | 27(24~31) | 10 | 53 | 1000 | 2000 | 6.0 | 10.0 | 0.1 | 7400 |
| 330KD14 | 330KD14J | 20 | 26 | 33(29.5~36.5) | 10 | 65 | 1000 | 2000 | 7.5 | 12.0 | 0.1 | 6100 |
| 390KD14 | 390KD14J | 25 | 31 | 39(35~43) | 10 | 77 | 1000 | 2000 | 8.6 | 13.0 | 0.1 | 5100 |
| 470KD14 | 470KD14J | 30 | 38 | 47(42~52) | 10 | 93 | 1000 | 2000 | 10.0 | 17.0 | 0.1 | 4300 |
| 560KD14 | 560KD14J | 35 | 45 | 56(50~62) | 10 | 110 | 1000 | 2000 | 11.0 | 20.0 | 0.1 | 3600 |
| 680KD14 | 680KD14J | 40 | 56 | 68(61~75) | 10 | 135 | 1000 | 2000 | 14.0 | 24.0 | 0.1 | 2900 |
| 820KD14 | 820KD14J | 50 | 65 | 82(74~90) | 50 | 135 | 4500 | 6000 | 22.0 | 27.0 | 0.6 | 2400 |
| 101KD14 | 101KD14J | 60 | 85 | 100(90~110) | 50 | 165 | 4500 | 6000 | 28.0 | 33.0 | 0.6 | 2000 |
| 121KD14 | 121KD14J | 75 | 100 | 120(108~132) | 50 | 200 | 4500 | 6000 | 32.0 | 40.0 | 0.6 | 1700 |
| 151KD14 | 151KD14J | 95 | 125 | 150(135~165) | 50 | 250 | 4500 | 6000 | 40.0 | 53.0 | 0.6 | 1300 |
| 181KD14 | 181KD14J | 115 | 150 | 180(162~198) | 50 | 300 | 4500 | 6000 | 50.0 | 60.0 | 0.6 | 1100 |
| 201KD14 | 201KD14J | 130 | 170 | 200(180~220) | 50 | 340 | 4500 | 6000 | 57.0 | 70.0 | 0.6 | 1000 |
| 221KD14 | 221KD14J | 140 | 180 | 220(198~242) | 50 | 360 | 4500 | 6000 | 60.0 | 78.0 | 0.6 | 900 |
| 241KD14 | 241KD14J | 150 | 200 | 240(216~264) | 50 | 395 | 4500 | 6000 | 63.0 | 84.0 | 0.6 | 830 |
| 271KD14 | 271KD14J | 175 | 225 | 270(243~297) | 50 | 455 | 4500 | 6000 | 70.0 | 99.0 | 0.6 | 740 |
| 301KD14 | 301KD14J | 190 | 250 | 300(270~330) | 50 | 500 | 4500 | 6000 | 77.0 | 108 | 0.6 | 670 |
| 331KD14 | 331KD14J | 210 | 275 | 330(297~363) | 50 | 550 | 4500 | 6000 | 85.0 | 115 | 0.6 | 610 |
| 361KD14 | 361KD14J | 230 | 300 | 360(324~396) | 50 | 595 | 4500 | 6000 | 93.0 | 130 | 0.6 | 560 |
| 391KD14 | 391KD14J | 250 | 320 | 390(351~429) | 50 | 650 | 4500 | 6000 | 100 | 140 | 0.6 | 510 |
| 431KD14 | 431KD14J | 275 | 350 | 430(387~473) | 50 | 710 | 4500 | 6000 | 115 | 155 | 0.6 | 460 |
| 471KD14 | 471KD14J | 300 | 385 | 470(423~517) | 50 | 775 | 4500 | 6000 | 118 | 175 | 0.6 | 430 |
| 511KD14 | 511KD14J | 320 | 415 | 510(459~561) | 50 | 845 | 4500 | 6000 | 121 | 180 | 0.6 | 390 |
| 561KD14 | 561KD14J | 350 | 460 | 560(504~616) | 50 | 925 | 4500 | 6000 | 125 | 185 | 0.6 | 360 |
| 621KD14 | 621KD14J | 385 | 505 | 620(558~682) | 50 | 1025 | 4500 | 6000 | 128 | 190 | 0.6 | 320 |
| 681KD14 | 681KD14J | 420 | 560 | 680(612~748) | 50 | 1120 | 4500 | 6000 | 130 | 200 | 0.6 | 290 |
| 751KD14 | 751KD14J | 460 | 615 | 750(675~825) | 50 | 1240 | 4500 | 6000 | 143 | 210 | 0.6 | 270 |
| 781KD14 | 781KD14J | 485 | 640 | 780(702~858) | 50 | 1290 | 4500 | 6000 | 148 | 220 | 0.6 | 260 |
| 821KD14 | 821KD14J | 510 | 670 | 820(738~902) | 50 | 1355 | 4500 | 6000 | 157 | 235 | 0.6 | 240 |
| 911KD14 | 911KD14J | 550 | 745 | 910(819~1001) | 50 | 1500 | 4500 | 6000 | 175 | 255 | 0.6 | 220 |
| 102KD14 | 102KD14J | 625 | 825 | 1000(900~1100) | 50 | 1650 | 4500 | 6000 | 190 | 280 | 0.6 | 200 |
| 112KD14 | 112KD14J | 680 | 895 | 1100(990~1210) | 50 | 1815 | 4500 | 6000 | 213 | 310 | 0.6 | 180 |
| 122KD14 | 122KD14J | 750 | 990 | 1200(1080~1320) | 50 | 1980 | 4500 | 6000 | 232 | 324 | 0.6 | 160 |
| 142KD14 | / | 880 | 1140 | 1400(1260~1540) | 50 | 2310 | 4500 | / | 238 | / | 0.6 | 150 |

| Part Number | | Maximum Allowable Voltage | | Varistor Voltage | Maximum Clamping Voltage | | Withstanding Surge Current | | Maximum Energy (10/1000μs) | | Rated Power | Typical Capacitance (Reference) |
|-------------|------------|---------------------------|---------------------|----------------------|--------------------------|--------------------|----------------------------|------------------|----------------------------|----------------|-------------|---------------------------------|
| Standard | High Surge | V _{AC} (V) | V _{DC} (V) | V _{1mA} (V) | I _P (A) | V _C (V) | I (A) Standard | I (A) High Surge | (J) Standard | (J) High Surge | (W) | @1KHz (pf) |
| 162KD14 | / | 1000 | 1280 | 1600(1440~1760) | 50 | 2640 | 4500 | / | 243 | / | 0.6 | 140 |
| 182KD14 | / | 1100 | 1465 | 1800(1620~1980) | 50 | 2970 | 4500 | / | 250 | / | 0.6 | 130 |

- Notes: 1. The tolerance of varistor voltage between 18V and 27V is more than 10%;
 2. Varistor voltage ≥ 1200V, structure diagram is F type;
 3. Leakage Current (@83% of V_{1mA}) : IR ≤ 50μA (180K~680K) ; IR ≤ 25μA (820K~182K).

Electrical Ratings

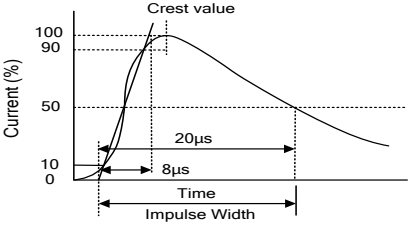
| Items | Test Condition/Description | Requirement | | | | | |
|------------------------------------|---|-----------------------------|--------------|--------------|--------------|---------------|--|
| Varistor Voltage | The voltage between the two terminals with the specified measuring current 1mA.DC applied is called V _b . | To meet the Specified value | | | | | |
| Maximum Allowable Voltage | The recommended maximum sine wave voltage (RMS) or the Maximum DC voltage can be applied continuously. | | | | | | |
| Maximum Clamping Voltage | The maximum voltage between the two terminals with the specification standard impulse current. Applied waveform: 8/20μs  | | | | | | |
| Rated Wattage | The maximum average power that can be applied within the specified ambient temperature. | | | | | | |
| Energy | The maximum energy within the varistor voltage change of ±10% when one impulse of 10/1000μs or 2ms is applied. | | | | | | |
| Withstanding Surge Current | The maximum current within the varistor voltage change of ±10% with the standard impulse current (8/20μs) applied one time. | | | | | | |
| Varistor Voltage Temp. Coefficient | $\left \frac{V_{1mA@105^{\circ}C} - V_{1mA@25^{\circ}C}}{V_{1mA@25^{\circ}C}} \times \frac{1}{80} \times 100\% (\%/^{\circ}C) \right $ $\left \frac{V_{1mA@-40^{\circ}C} - V_{1mA@25^{\circ}C}}{V_{1mA@25^{\circ}C}} \times \frac{1}{65} \times 100\% (\%/^{\circ}C) \right $ | | ≤ 0.05%/°C | | | | |
| Surge Life | The change of V _b shall be measured after the impulse listed below which is applied 10,000 times continuously with the interval of ten seconds at room temperature. <table border="1" style="margin-left: auto; margin-right: auto;"> <tr> <td rowspan="2">14Φ series</td> <td>180K to 680K</td> <td>75A (8/20μs)</td> </tr> <tr> <td>820K to 182K</td> <td>150A (8/20μs)</td> </tr> </table> | 14Φ series | 180K to 680K | 75A (8/20μs) | 820K to 182K | 150A (8/20μs) | $\frac{\Delta V_b}{V_b} \leq \pm 10\%$ |
| 14Φ series | 180K to 680K | | 75A (8/20μs) | | | | |
| | 820K to 182K | 150A (8/20μs) | | | | | |

Soldering Recommendation

Lead-free Wave Soldering Recommendation

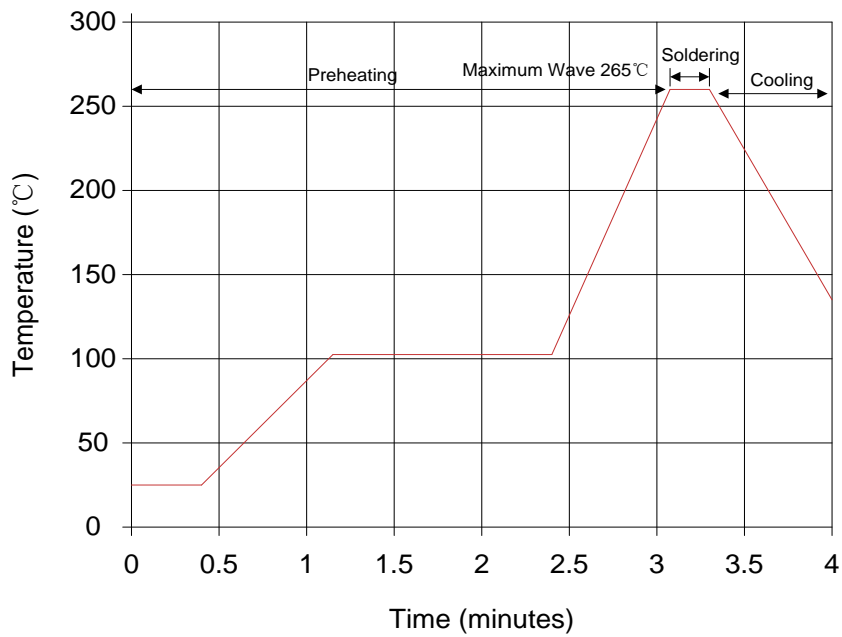

| Item | Conditions |
|------------------|-------------------|
| Peak Temperature | 265°C |
| Dipping Time | 10 seconds (max.) |
| Soldering | 1 time |

Recommendation Reworking Conditions with Soldering Iron

| Item | Conditions |
|-----------------------------------|------------------|
| Temperature of Soldering Iron-tip | 360°C (max.) |
| Soldering Time | 3 seconds (max.) |
| Distance from Varistor | 2mm (min.) |

Mechanical Characteristics

| Items | Test conditions / Methods | Specifications | | | | | | | | |
|-------------------------------|--|--|------------|-----------|-----|------------|-----|--------|-----|---|
| Tensile Strength of Terminals | Gradually applying the force specified and keeping the unit fixed for 10±1 sec. <table border="1" style="margin-left: auto; margin-right: auto;"> <thead> <tr> <th>Terminal diameter (mm)</th> <th>Force (kg)</th> </tr> </thead> <tbody> <tr> <td>0.5<d≤0.8</td> <td>1.0</td> </tr> <tr> <td>0.8<d≤1.25</td> <td>2.0</td> </tr> <tr> <td>1.25<d</td> <td>4.0</td> </tr> </tbody> </table> | Terminal diameter (mm) | Force (kg) | 0.5<d≤0.8 | 1.0 | 0.8<d≤1.25 | 2.0 | 1.25<d | 4.0 | No visible damage ΔV _{1mA} /V _{1mA} ≤5% |
| Terminal diameter (mm) | Force (kg) | | | | | | | | | |
| 0.5<d≤0.8 | 1.0 | | | | | | | | | |
| 0.8<d≤1.25 | 2.0 | | | | | | | | | |
| 1.25<d | 4.0 | | | | | | | | | |
| Bending Strength of Terminals | Hold specimen and apply the force specified below to each lead. Bend the specimen to 90°, then return to the original position. Repeat the procedure in the opposite direction. <table border="1" style="margin-left: auto; margin-right: auto;"> <thead> <tr> <th>Terminal diameter (mm)</th> <th>Force (kg)</th> </tr> </thead> <tbody> <tr> <td>0.5<d≤0.8</td> <td>0.5</td> </tr> <tr> <td>0.8<d≤1.25</td> <td>1.0</td> </tr> <tr> <td>1.25<d</td> <td>2.0</td> </tr> </tbody> </table> | Terminal diameter (mm) | Force (kg) | 0.5<d≤0.8 | 0.5 | 0.8<d≤1.25 | 1.0 | 1.25<d | 2.0 | No visible damage ΔV _{1mA} /V _{1mA} ≤5% |
| Terminal diameter (mm) | Force (kg) | | | | | | | | | |
| 0.5<d≤0.8 | 0.5 | | | | | | | | | |
| 0.8<d≤1.25 | 1.0 | | | | | | | | | |
| 1.25<d | 2.0 | | | | | | | | | |
| Vibration | Frequency range: 10~55 Hz Amplitude: 0.75mm or 98m/s ² Direction: 3 mutually perpendicular directions, 2hrs each. | No visible damage ΔV _{1mA} /V _{1mA} ≤5% | | | | | | | | |
| Solder ability | Solder Temp: 245±5°C Dipping Time: 2±0.5 sec | At least 95% of terminal electrode is covered by new solder | | | | | | | | |
| Resistance to Soldering Heat | Solder Temp: 260±5°C Dipping Time: 10±1 sec | No visible damage ΔV _{1mA} /V _{1mA} ≤10% | | | | | | | | |

Reliability

| Items | Test conditions / Methods | Specifications | | | | | | | | | | | | | | | |
|--------------------------|--|--|------------------|------------------|---|-------|------|---|------------------|------|---|-------|------|---|------------------|------|---|
| High Temperature Storage | Ambient Temp: 125±2°C Duration: 1000hrs | ΔV _{1mA} /V _{1mA} ≤5% | | | | | | | | | | | | | | | |
| Low Temperature Storage | Ambient Temp: -40±2°C Duration: 1000hrs | ΔV _{1mA} /V _{1mA} ≤5% | | | | | | | | | | | | | | | |
| Humidity | Ambient Temp: 40±2°C, 90~95% R.H. Duration: 1000hrs | ΔV _{1mA} /V _{1mA} ≤5% | | | | | | | | | | | | | | | |
| Temperature Cycle | The conditions shown below shall be repeated 5 cycles <table border="1" style="margin-left: auto; margin-right: auto;"> <thead> <tr> <th>Step</th> <th>Temperature (°C)</th> <th>Period (minutes)</th> </tr> </thead> <tbody> <tr> <td>1</td> <td>-40±3</td> <td>30±3</td> </tr> <tr> <td>2</td> <td>Room temperature</td> <td>15±3</td> </tr> <tr> <td>3</td> <td>125±3</td> <td>30±3</td> </tr> <tr> <td>4</td> <td>Room temperature</td> <td>15±3</td> </tr> </tbody> </table> | Step | Temperature (°C) | Period (minutes) | 1 | -40±3 | 30±3 | 2 | Room temperature | 15±3 | 3 | 125±3 | 30±3 | 4 | Room temperature | 15±3 | No visible damage ΔV _{1mA} /V _{1mA} ≤5% |
| Step | Temperature (°C) | Period (minutes) | | | | | | | | | | | | | | | |
| 1 | -40±3 | 30±3 | | | | | | | | | | | | | | | |
| 2 | Room temperature | 15±3 | | | | | | | | | | | | | | | |
| 3 | 125±3 | 30±3 | | | | | | | | | | | | | | | |
| 4 | Room temperature | 15±3 | | | | | | | | | | | | | | | |
| High Temperature Load | Ambient Temp: 105±2°C Duration: 1000hrs Load: Max. Allowable Voltage In AC eara. | ΔV _{1mA} /V _{1mA} ≤10% | | | | | | | | | | | | | | | |
| Damp Heat Load | Ambient Temp: 40±2°C, 90~95% R.H. Duration: 1000hrs Load: Max. Allowable Voltage | No visible damage ΔV _{1mA} /V _{1mA} ≤10% | | | | | | | | | | | | | | | |
| Voltage Proof | Metal balls method, 2500Vac 1 min. | No visible damage | | | | | | | | | | | | | | | |

Maximum Surge Current Derating Curve

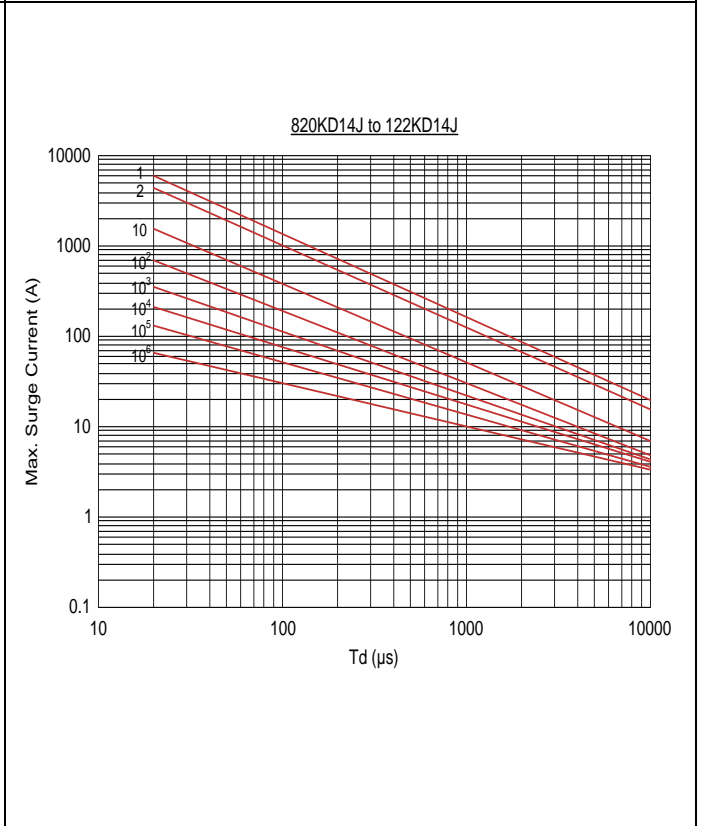
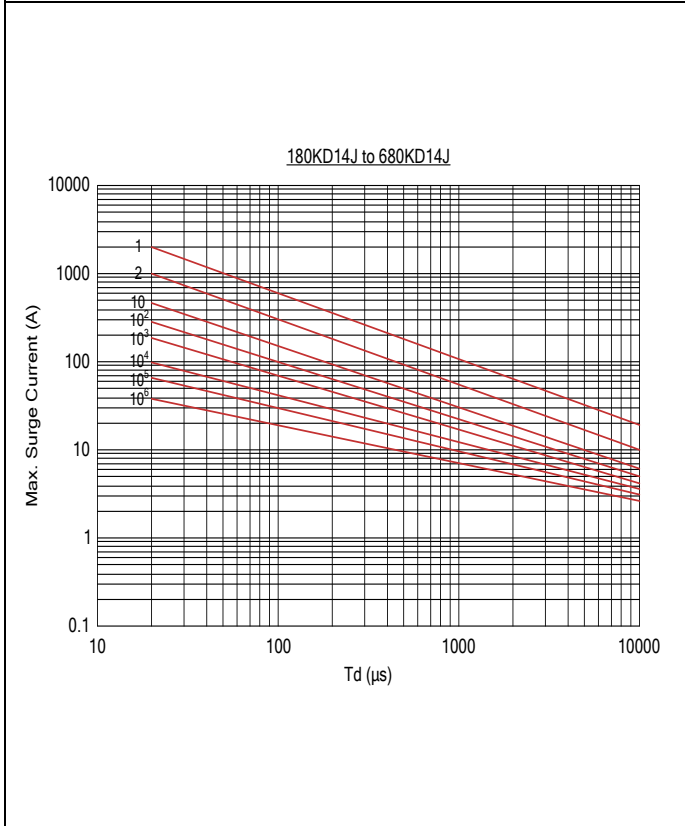
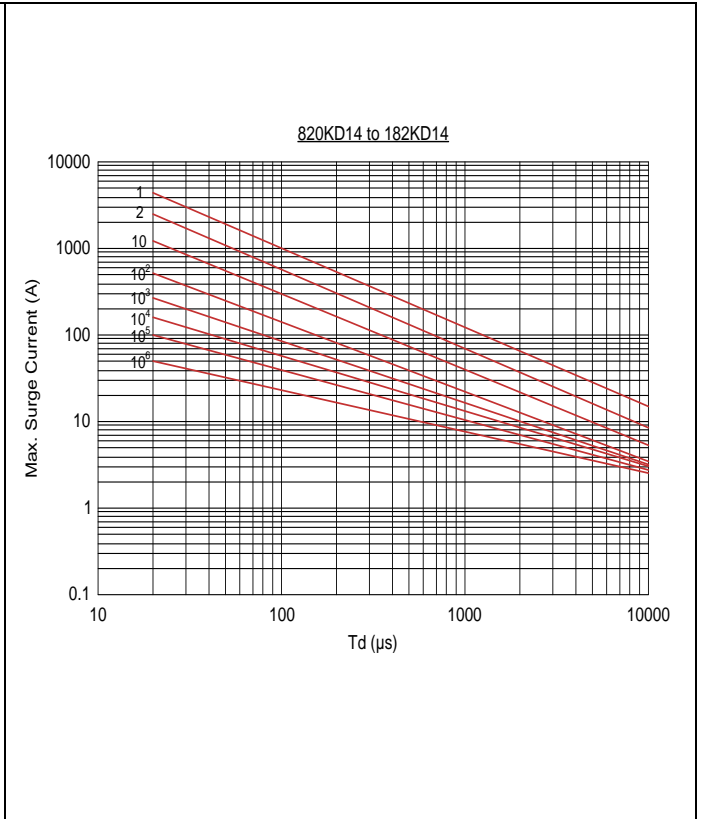
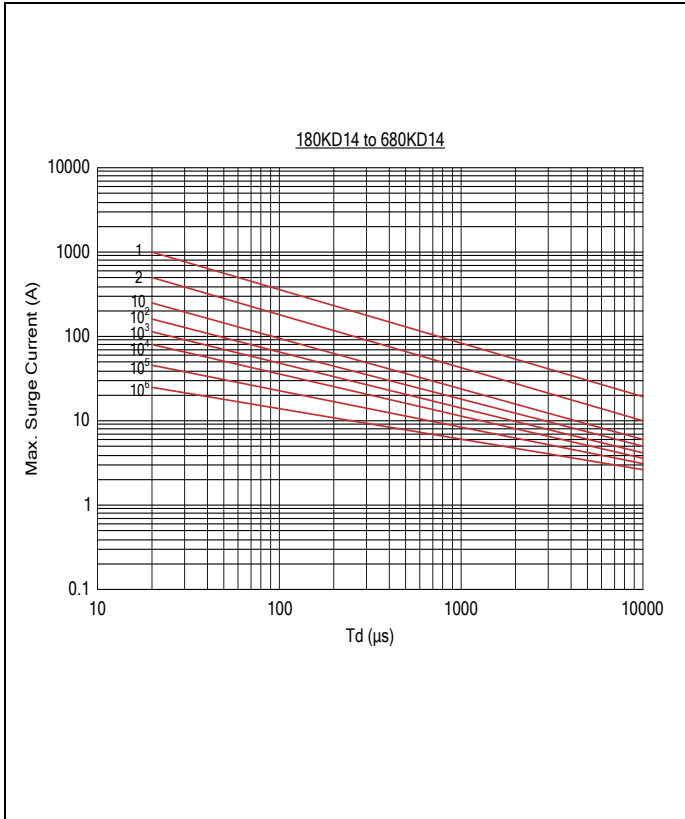

Maximum Leakage Current and Maximum Clamping Voltage Curve

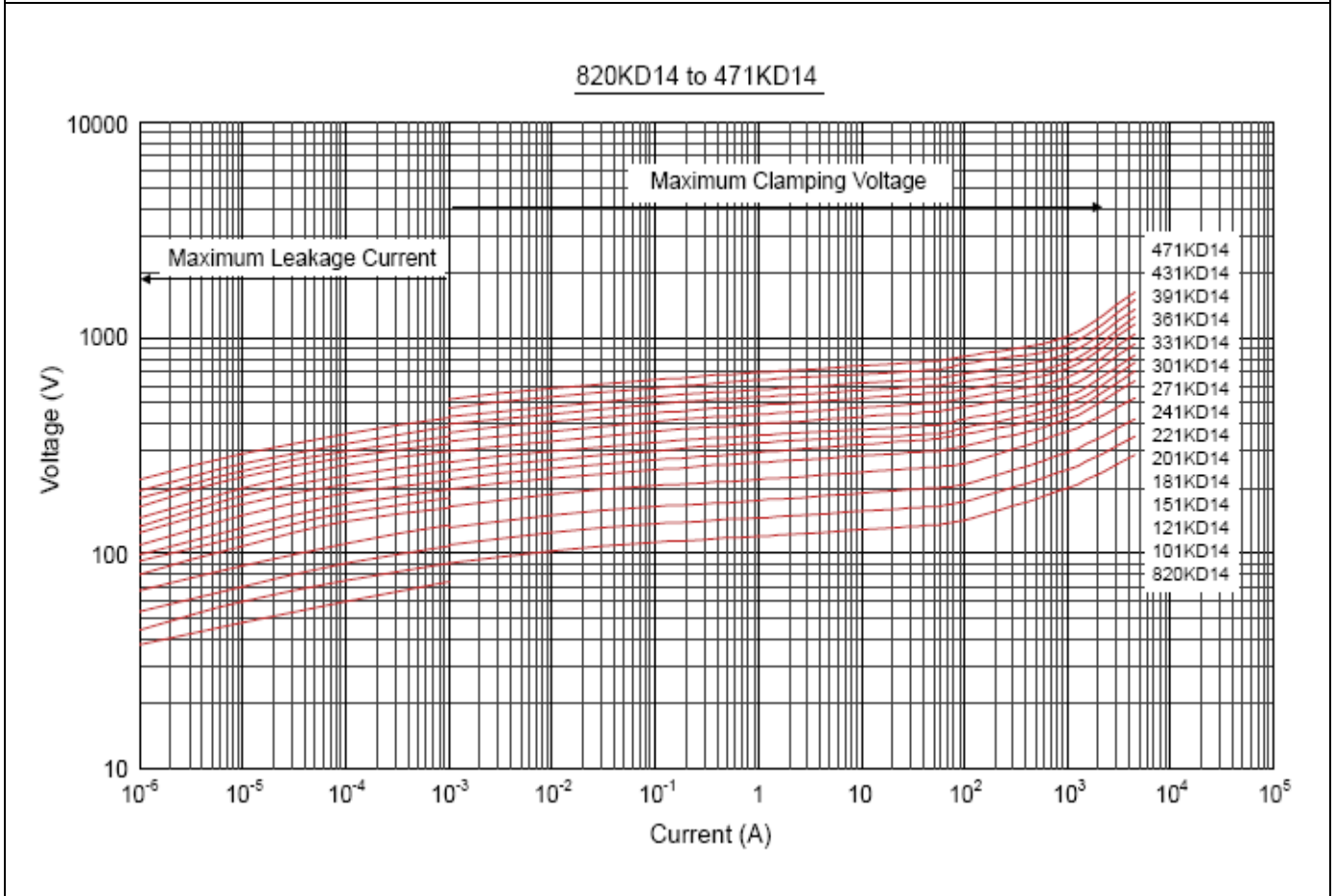
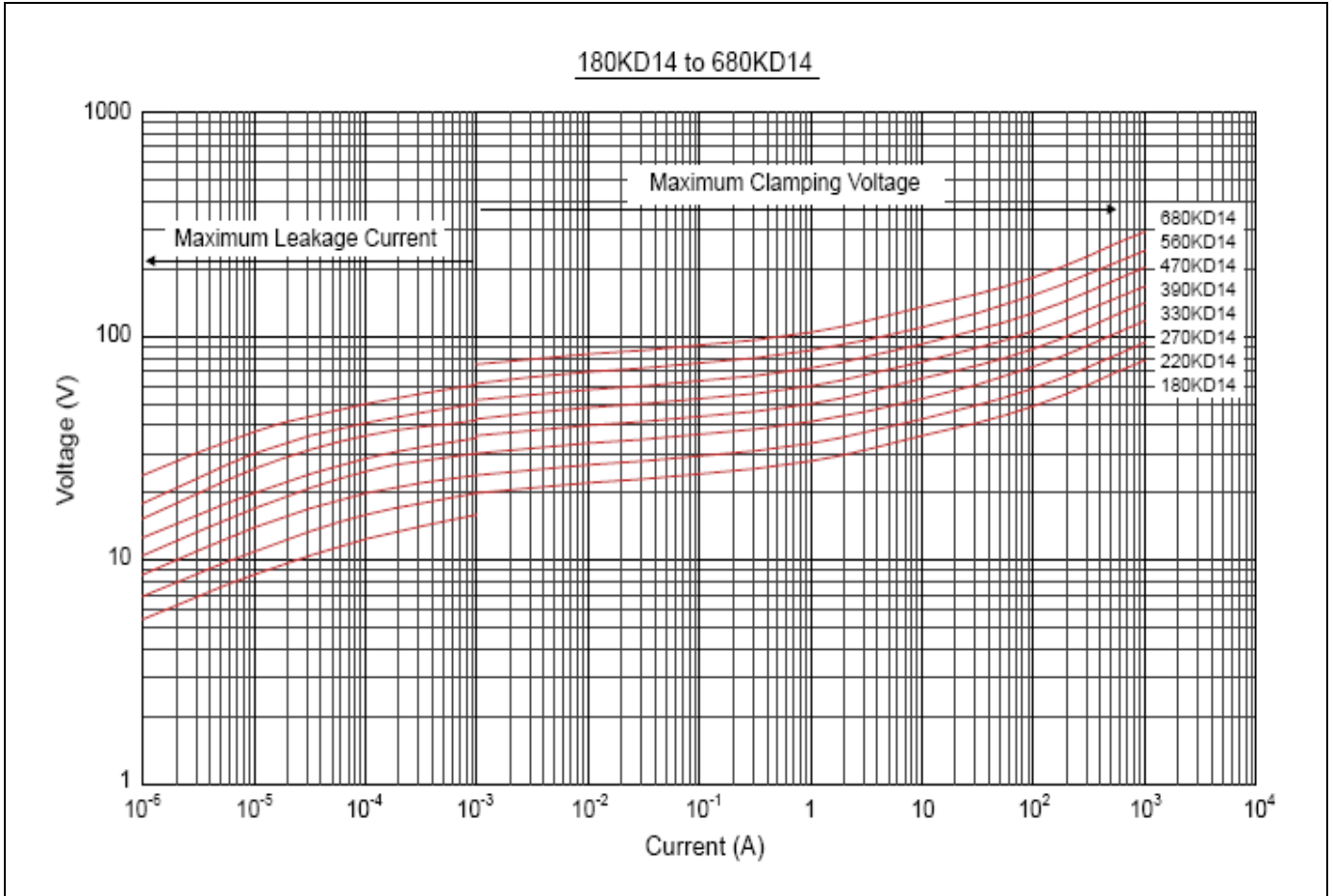

Maximum Leakage Current and Maximum Clamping Voltage Curve

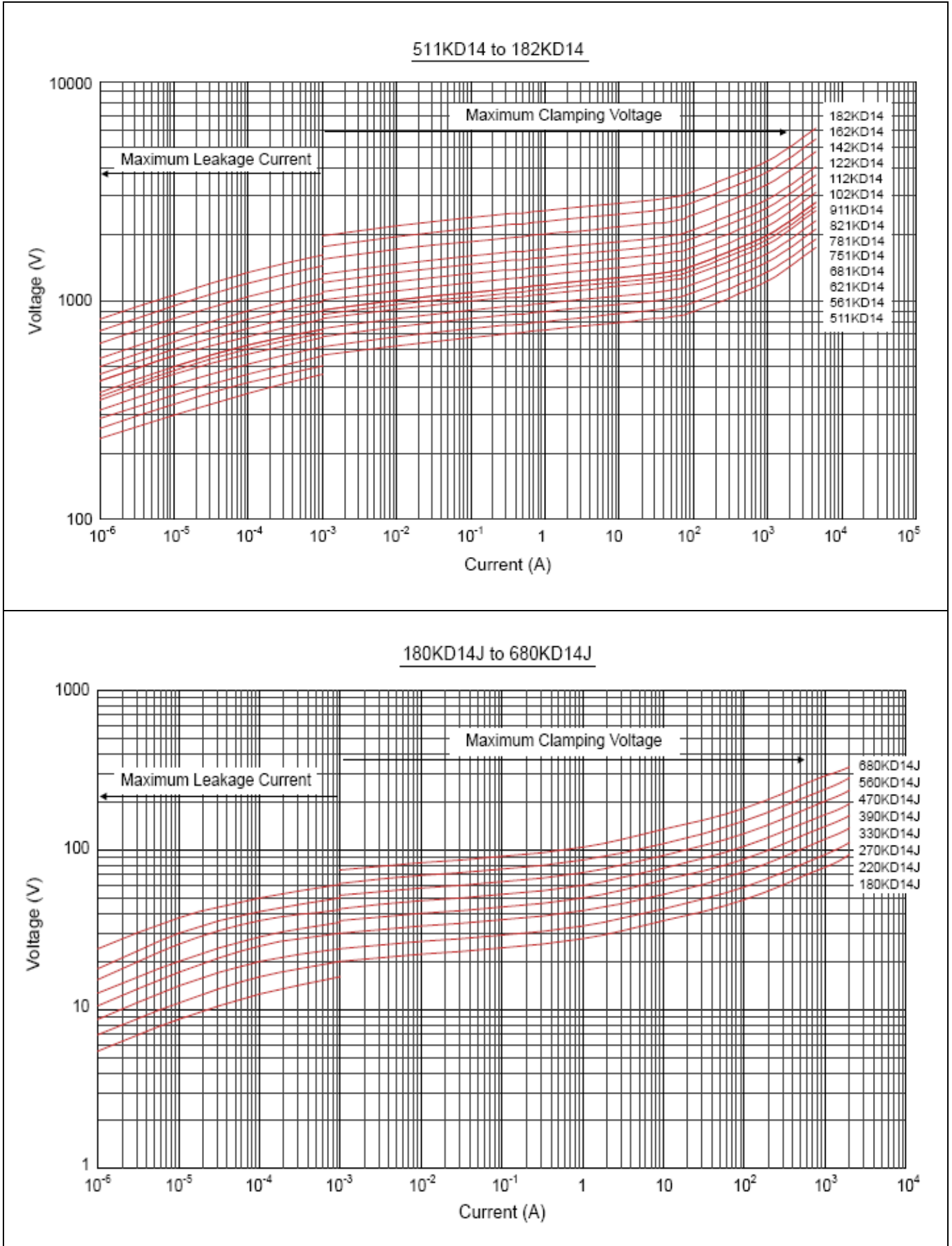

Maximum Leakage Current and Maximum Clamping Voltage Curve

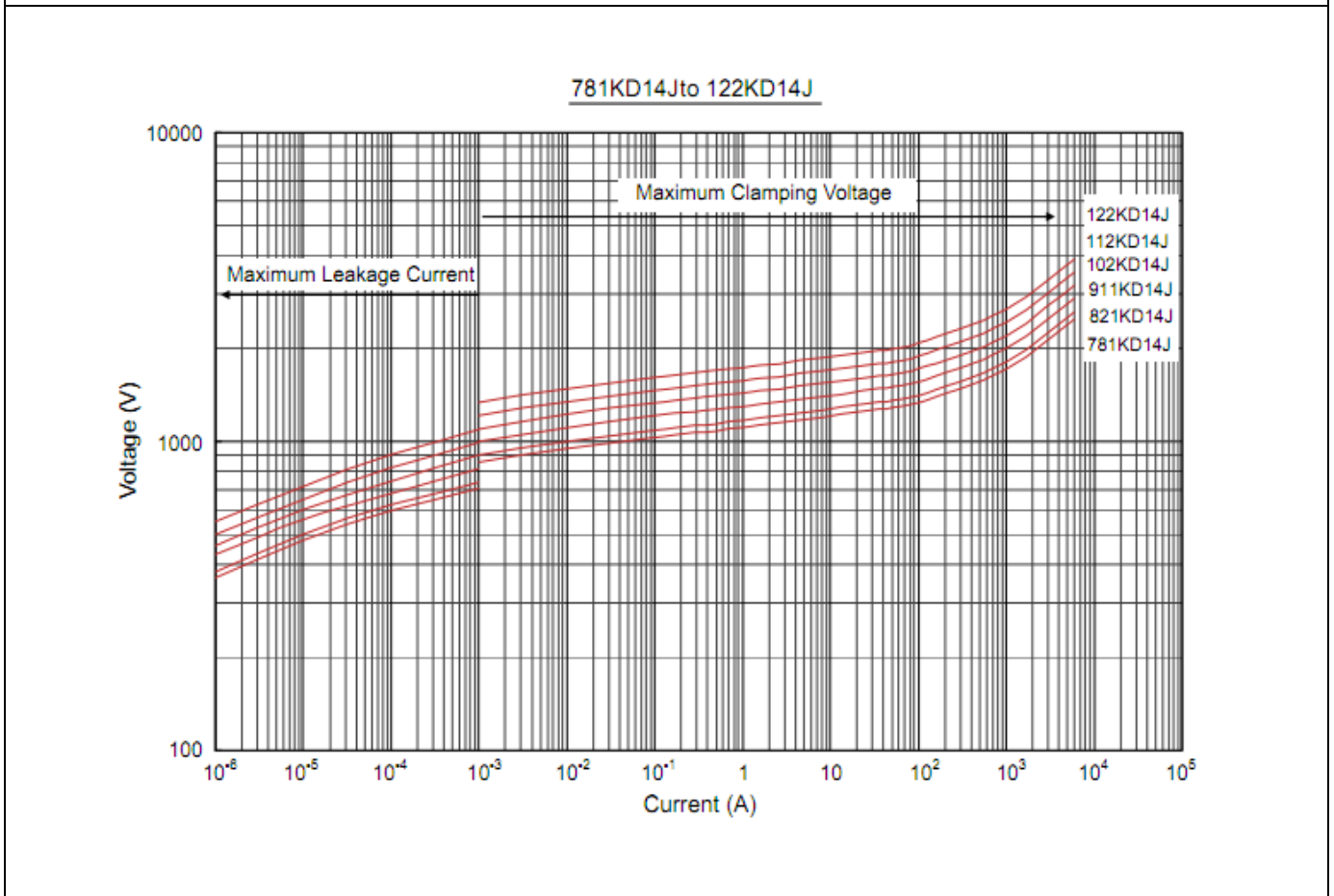
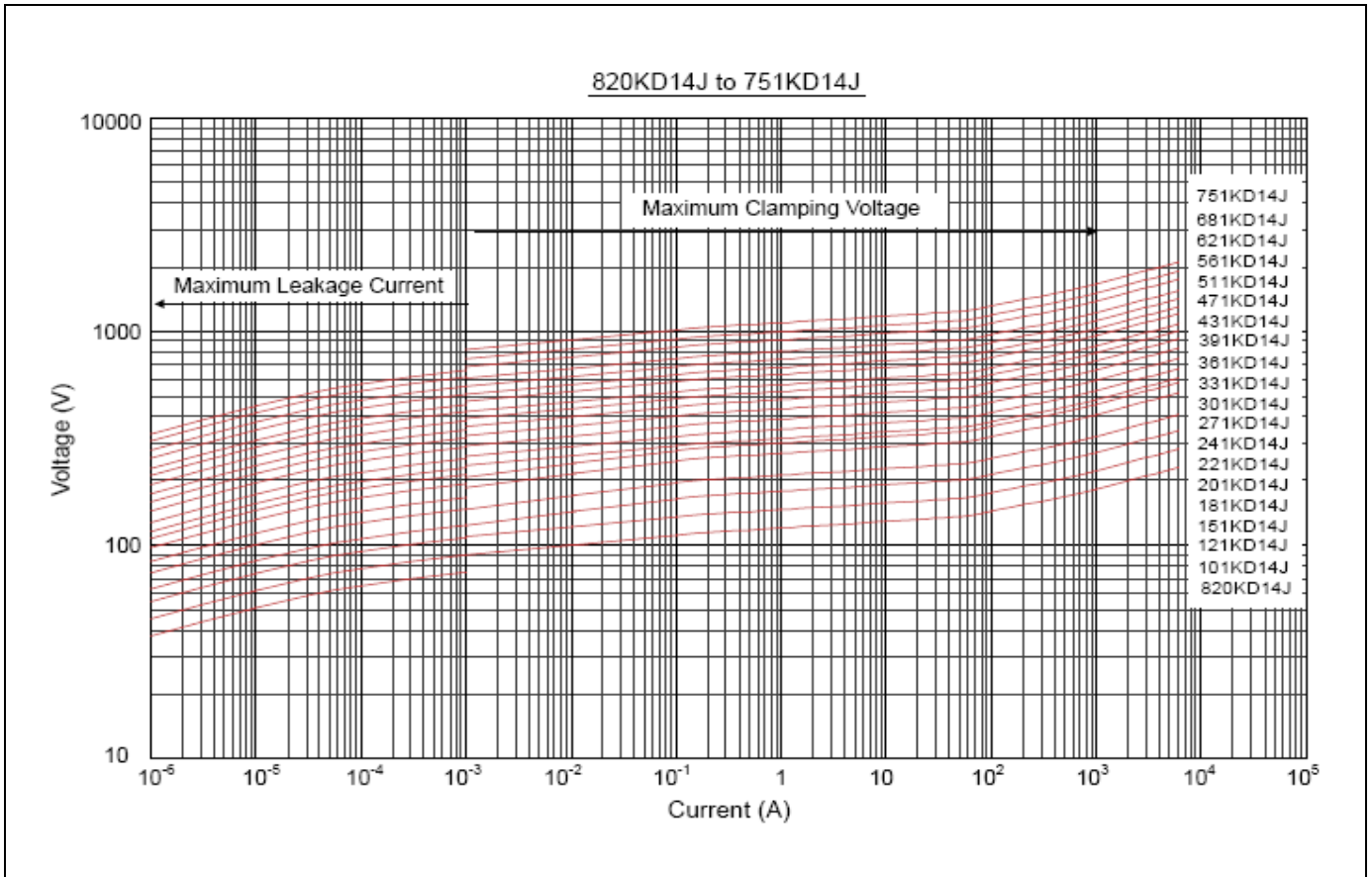

Marking Code

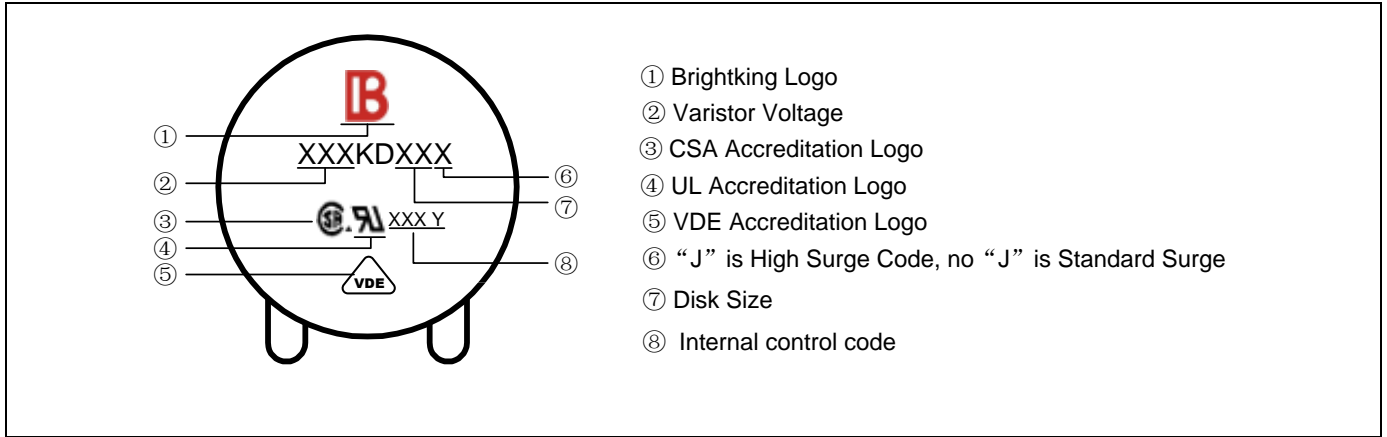

Taping Dimensions

| Symbol | Dimensions (mm) |
|--------|-----------------|
| P | 25.4±1.0 |
| P0 | 12.7±1.0 |
| P1 | 8.95±0.7 |
| P2 | 12.7±1.3 |
| F | 7.5±0.8 |
| h | 0±4 |
| W | 18.0±1.0 |
| W0 | 12.0±1.0 |
| W1 | 9.0±0.5 |
| W2 | 3.0max |
| H | 20.0±2.0 |
| I | 2.0max |
| D0 | 4.0±0.2 |
| t | 0.6±0.3 |
| B | 40max |

Quantity

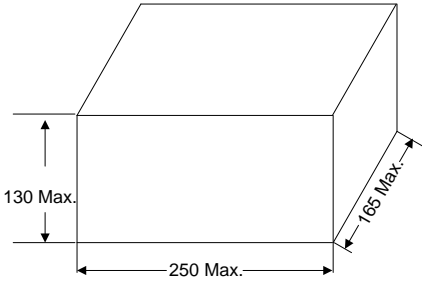
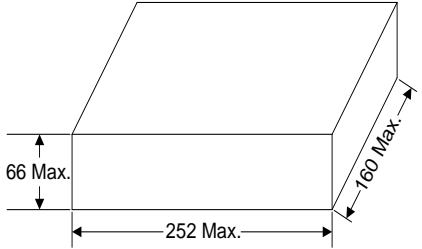
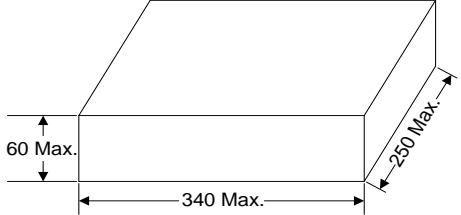
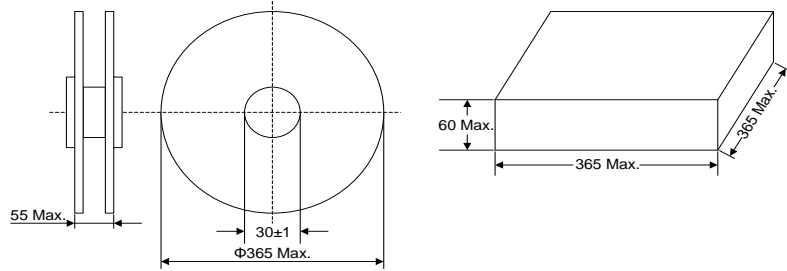
| Packaging Dimensions (Unit: mm) | Quantity |
|---|--|
| <p>In bulk for Terminals Untrimmed Products</p>  | 400pcs/bag 4bags/box (180K~331K) |
| | 300pcs/bag 4bags/box (361K~621K) |
| | 250pcs/bag 4bags/box (681K~112K) |
| | 150pcs/bag 4bags/box (122K~182K) |
| <p>In bulk for Terminals Trimmed Products</p>  | 400pcs/bag 4bags/box (180K~331K) |
| | 300pcs/bag 4bags/box (361K~621K) |
| | 250pcs/bag 4bags/box (681K~112K) |
| | 150pcs/bag 4bags/box (122K~182K) |
| <p>Tape & Box</p>  | 750pcs/box (180K~241K) |
| | 600pcs/box (271K~331K) |
| | 500pcs/box (361K~621K) |
| | 400pcs/box (681K~751K) |
| <p>Tape & Reel</p>  | 1000pcs/reel (180K~331K) |
| | 750pcs/reel (361K~621K) |
| | 500pcs/reel (681K~751K) |