

1 Channel Ultra-low Capacitance ESD Protection

1. Features

- Ultra-Low capacitance:0.05pF(typ.)
- Low leakage current(<10nA)
- Fast response time(<1ns)
- Bi-directional, single line protection
- IEC 61000-4-2 (ESD Air): 15kV
IEC 61000-4-2 (ESD Contact): 8kV

2. Pin Description

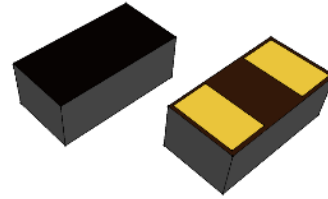

3. Applications

- USB 3.0/3.1
- HDMI 1.3/1.4/2.0
- RF Antenna
- SATA and eSATA Interface

4. Schematic Diagram

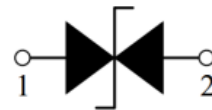

5. Order Information

Type	Package	Size (mm)	Delivery Form	Delivery Quantity
SLPESD0603M16	0603	1.60x0.80x0.40	7" T&R	5,000

6. Limiting Values($T_A = 25\text{ }^\circ\text{C}$, unless otherwise specified)

Symbol	Parameter	Conditions	Min	Max	Unit
V_{ESD}	Electrostatic Discharge Voltage	IEC 61000-4-2; Contact Discharge	-	8	kV
		IEC 61000-4-2; Air Discharge	-	15	kV
T_A	Operating Temperature Range	-	-55	125	$^\circ\text{C}$
T_{stg}	Storage Temperature Range	-	-40	85	$^\circ\text{C}$

7. Electrical Characteristics($T_A = 25\text{ }^\circ\text{C}$ unless otherwise specified)

Symbol	Parameter	Conditions	Min	Typ.	Max	Unit
V_{DC}	Continuous Operating Voltage	-	-	-	16	V
V_T	Trigger Voltage	IEC61000-4-2 8kV contact discharge	-	450	-	V
V_C	Clamping Voltage	IEC61000-4-2 8kV contact discharge	-	40	-	V
I_L	Leakage Current	DC 5V shall be applied on component	-	-	10	nA
C_J	Capacitance	Measured at 10MHz	-	0.05	-	pF

8. Typical Characteristics

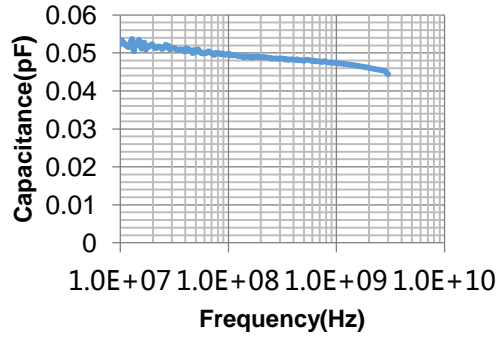
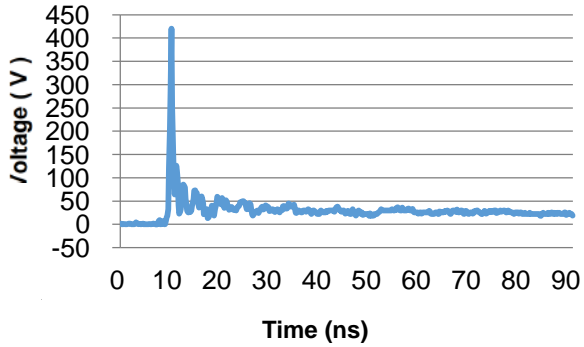

9. ESD Protection for Signal Line

The SLPESD is designed for the protection of one bidirectional data line from ESD damage.

- Place the SLPESD as close to the input terminal or connector as possible.
- Minimize the path length between the SLPESD and the protected signal line.
- Use ground planes whenever possible.

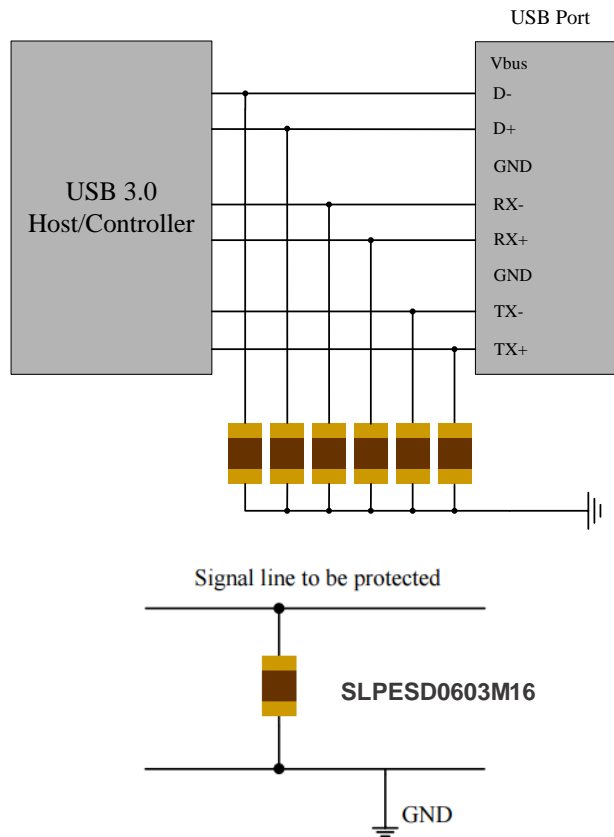

10. Package Dimension

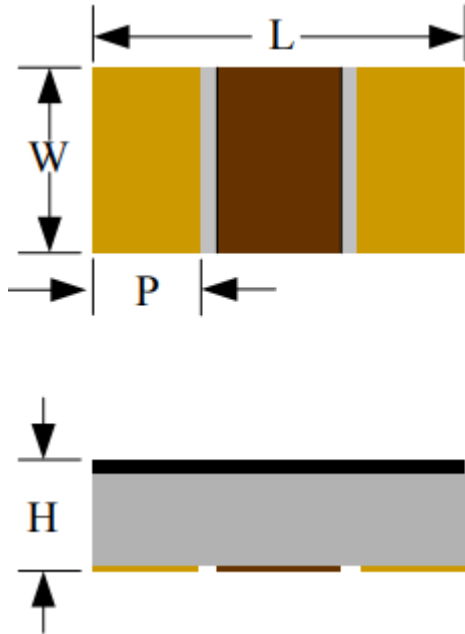

Recommended Solder Pad Footprint

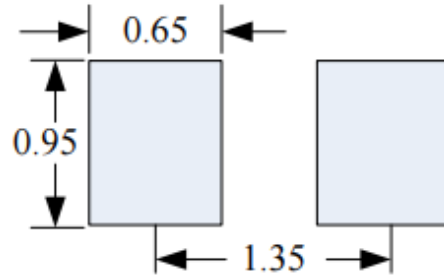

***Sizes in mm**

Notes:

This solder pad layout is for reference purposes only.

Dimension	Unit: Millimeters	
	Min.	Max.
L	1.45	1.75
W	0.70	0.95
P	0.20	0.50
H	0.26	0.46

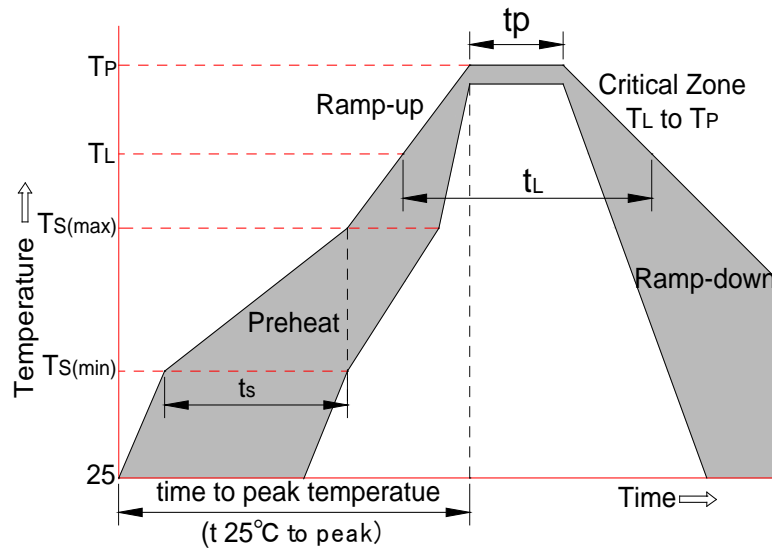
11. Soldering Parameters

Reflow Condition		Pb-Free Assembly
Pre-heat	-Temperature Min ($T_{s(min)}$)	+150°C
	-Temperature Max($T_{s(max)}$)	+200°C
	-Time (Min to Max) (t_s)	60-180 secs.
Average ramp up rate (Liquid us Temp (T_L) to peak)		3°C/sec. Max
$T_{s(max)}$ to T_L - Ramp-up Rate		3°C/sec. Max
Reflow	-Temperature(T_L)(Liquid us)	+217°C
	-Temperature(t_L)	60-150 secs.
Peak Temp (T_p)		+260(+0/-5)°C
Time within 5°C of actual Peak Temp (t_p)		30 secs. Max
Ramp-down Rate		6°C/sec. Max
xTime 25°C to Peak Temp (T_p)		8 min. Max
Do not exceed		+260°C