

Rev.	ECN Number	Description	Date	Drawn	Checked	Approved

技术要求:

1. 材质: 不锈钢 SUS301, T=0.10±0.005;
2. 端子锡脚焊接面和接触面不可有毛边, 其他部位毛边最大0.03mm;
3. 扭曲: 4.5°/1000mm, 拱形 5mm/1000mm;
4. 标示有“▼”符号的为重点控制和检验尺寸;
5. 未标注之R MAX R0.13;
6. 电镀须满足48小时盐雾测试;
7. 寿命测试>2万次, 产品弹力要求在60gf~80gf之间
8. 镀底50~80U“min”, 产品外表面镀全1U“MIN

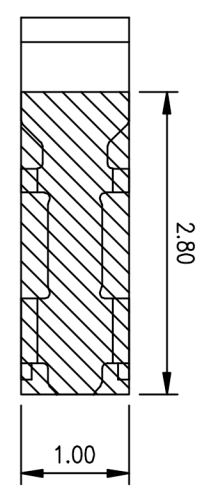
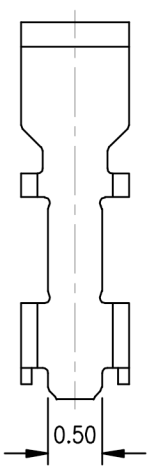
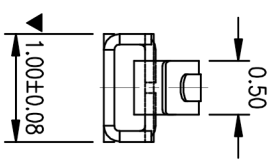
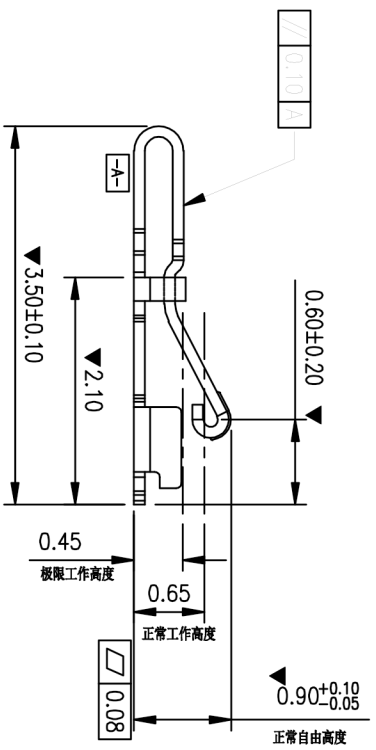
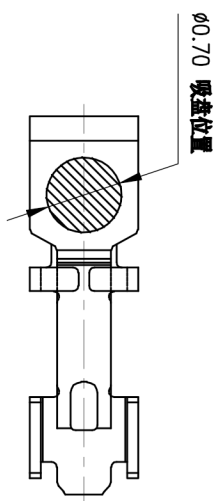

焊接尺寸

尺寸公差 ±0.05

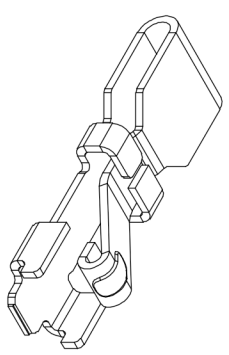

 深圳市蝙蝠无线科技有限公司 Shenzhen bats wireless co., LTD		GENERAL TOLERANCE		SCALE:	DATE	DWG. NO.	TITLE	REV.
		XX. ±0.50	X. ±0.35	1:1	DATE	681-0038A-2	客户图	A
UNIT:		CHECK		DATE	PARTS NO. (INTENDED USE)		RF Antenna Spring, SMT,	SHEET
X. ±0.25		X. ±1.0'		DATE	BW0038AG-L3.5W1.0H0.9		L3.50*W1.0*H0.9mm	1/1
.XX ±0.15		.XX ±0.5'		DATE				
SIZE: A4		APPROVE		DATE				