

产品规格书

Product Specification

| | |
|-----------------------|---------------------------|
| 产品料号/Part Number | P12210069 |
| 产品型号/Product Model | P2-1204RTS2-1.5T |
| 产品名称/Product Name | 1204 红光 1204 Red Light |
| 胶体颜色/Colloidal Color | 透明 Water clear |
| 发光颜色/Luminous Color | 红光 Red Light |
| 半功率视角/Half Power View | 120° |
| 生效日期: Effective Date | 2021-02-26 |

注：如中英文译文有冲突请以中文为准。

| 制作 Prepared | 审核 Checked | 核准 Approved | 业务 Salesman |
|----------------|---------------|----------------|----------------|
| | | | |

| | | |
|--|--|--|
| 客户承认结果 Customer acknowledges Results | | |
| | | |

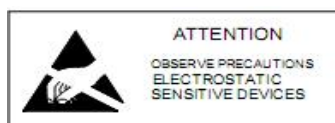

1. 产品描述: Product Description:

- 外观尺寸(L/W/H) : Appearance Dimensions 3.2*1.0*1.5 mm
- 防潮铝袋标准包装: EIA Standard Packing
- 环保产品, 符合ROHS要求: Eco-products, Compliance With ROHS Requirments
- 适用于自动贴片机: For Infrared Reflow soldering Process

2. 产品主要应用: Product Applications:

- 背光 Backlight
- 照明 Lighting
- 发光指示灯 Indicator light
- 红外应用系统 Infrared Applications systems
- 其他 Others

3. 外观尺寸及建议焊盘尺寸: Size of Appearance & Suggested Soldering PAD

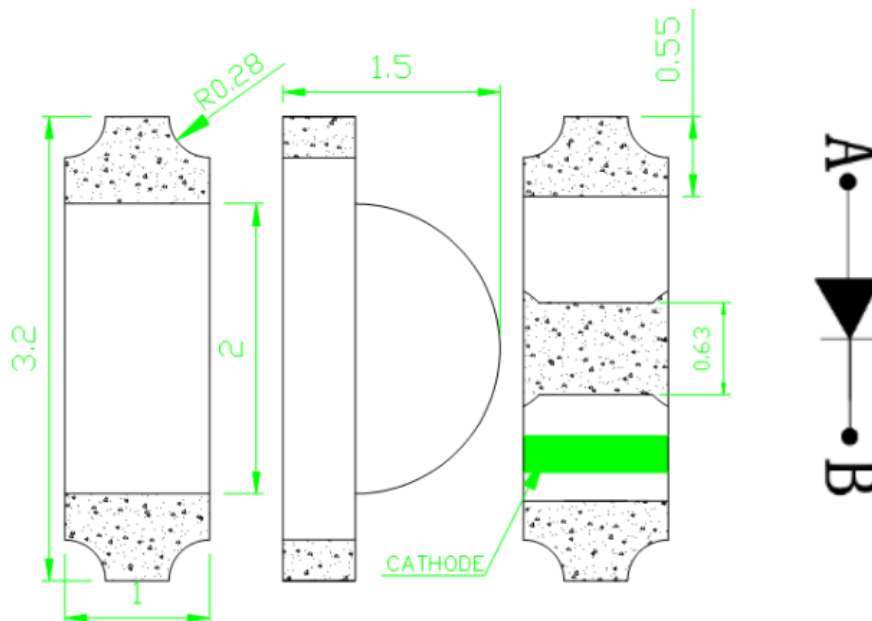

Recommended Soldering Pattern
(Units : mm)-

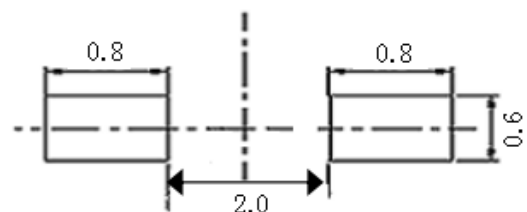

注: Note

1. 单位: 毫米 (mm) 1. Dimensions in millimeters

2. 公差: 如无特别标注则为 ± 0.10mm; 2. Tolerances are ±0.10mm unless mentioned

4. 建议焊接温度曲线：Recommended Reflow Soldering Temperature Curve:

无铅焊接：（Lead-free Soldering）

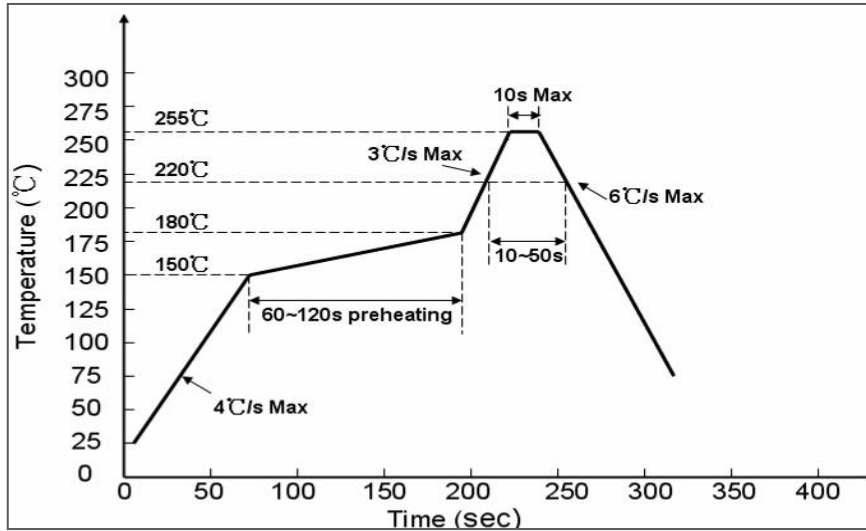

注：Note

1. 灯珠在温度较高时不要施加外力在灯珠上；
1.Do not force on LEDs while it is at high temperature;
2. 回流焊不可超过两次；若过炉两次，建议两次过炉时间不可超过 12H；
2.Reflow soldering is below 2 times; it is suggested to be less than 12hrs if soldered twice.
3. 回流焊是建议的焊接加工方式，其它焊接方式可能会对灯珠造成损坏；
3.Reflow soldering is recommended, others might cause damage to the LEDs;

5. 最大绝对额定值： Absolute Maximum Ratings (Ta=25°C)：

| Parameter 参数 | Symbol 符号 | Value 额定值 | Unit 单位 |
|---|--------------|--|------------|
| 消耗功率 Power Dissipation | Pd | 60 | mW |
| 最大脉冲电流* Max Pulse Current | IFP | 100 | mA |
| 正向直流工作电流 DC Forward Current | IF | 30 | mA |
| 反向电压 Reverse breakdown Voltage | VR | 5 | V |
| 抗静电能力（人体模式） Electrostatic Discharge Threshold (HBM) | ESD | 2500 | V |
| 工作环境温度 Operating Temperature | Topr | -40 to 85°C | °C |
| 储存环境温度 Storage Temperature | Tstg | -40 to 85°C | °C |
| 焊接温度 Soldering Temperature | Tsol | Reflow soldering（回流焊）： 260°C/10S Hands soldering（手工焊）： 320°C/3S | °C |

6. 光电特性参数: Electro-Optical Characteristics (Ta=25°C):

| 参数 Parameter | 符号 Symbol | 最小值 Min | 典型值 Typ | 最大值 Max | 单位 Unit | 测试条件 Test condition |
|-------------------------------------|-----------------|------------|------------|------------|------------|------------------------|
| 亮度 Luminous Intensity | IV | 100 | --- | 200 | mcd | IF=20mA |
| 主波长 Dominant wavelength | λ_d | 620 | --- | 625 | nm | IF=20mA |
| 正向电压 Forward Voltage | VF | 1.8 | 2.0 | 2.4 | V | IF=20mA |
| 峰值波长 Peak Wavelength | λ_P | --- | 633 | --- | nm | IF=20mA |
| 半波宽 Spectrum Radiation Bandwidth | $\Delta\lambda$ | --- | 18 | --- | nm | IF=20mA |
| 反向漏电流 Reverse Current | IR | --- | --- | 10 | uA | VR=5V |
| 半功率视角 Half Power View | 2 θ 1/2 | --- | 120 | --- | deg | IF=20mA |

7. 光电参数代表值特征曲线: Typical Optical-Electronic Characteristic Curves

强度 VS 波长
Relative Intensity vs. Wavelength

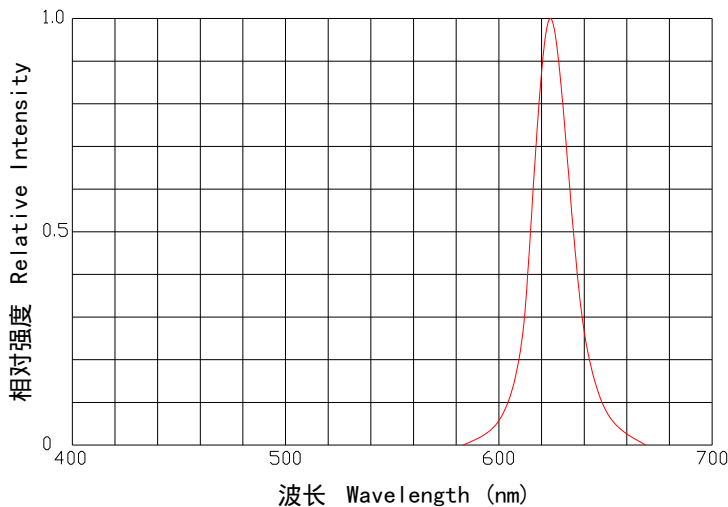

电流 VS 电压
Forward current vs. Forward voltage

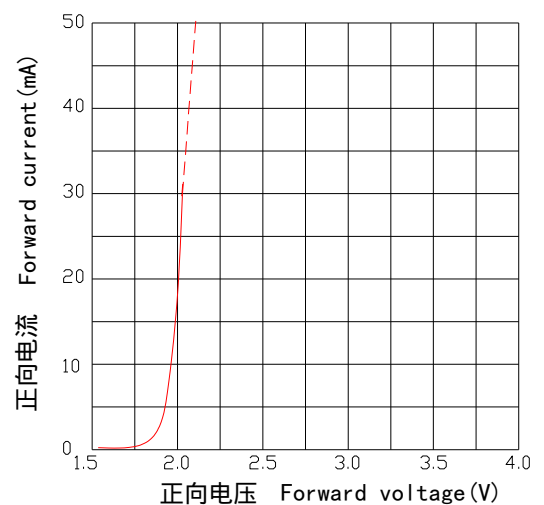

正向电流额定参数曲线
Forward current Derating Curve

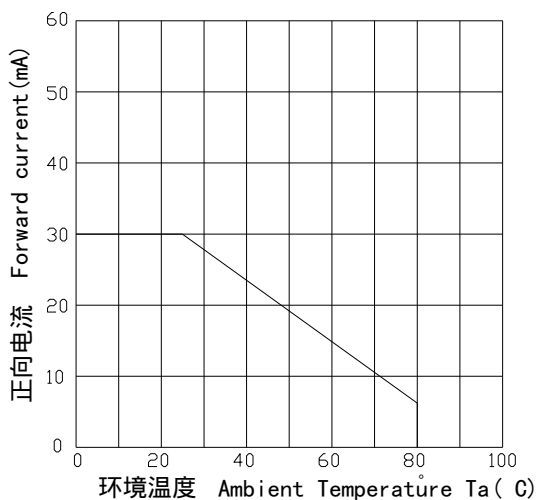

发光强度 VS 电流
Relative Luminous Intensity vs. Forward Current

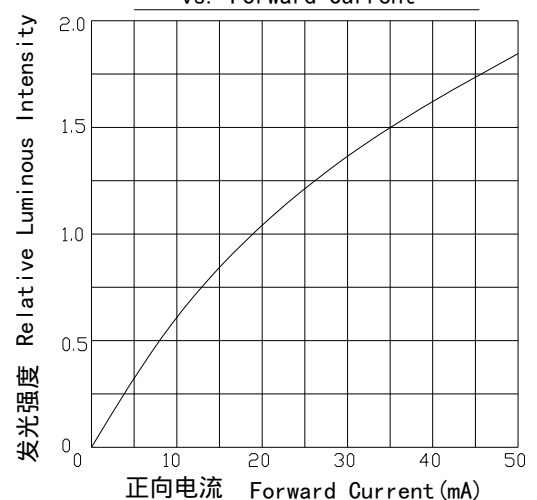

发光强度 VS 环境温度

Luminous Intensity vs. Ambient Temperature

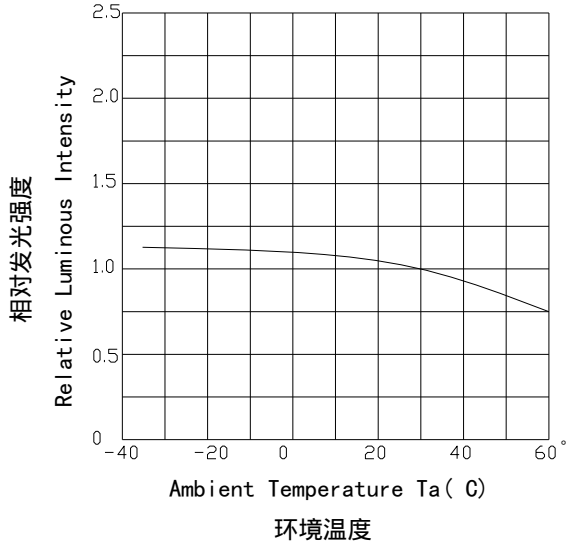

辐射图

Radiation Diagram

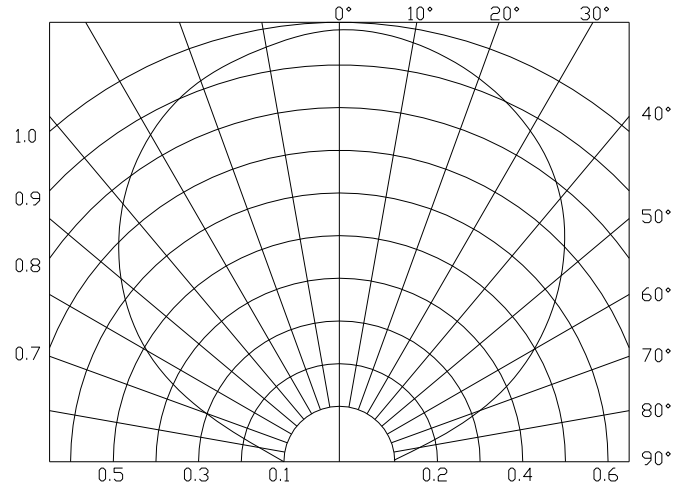

8. 标签标识: Label Identifier

| | |
|--------|--------|
| Name : | |
| P/N : | |
| VF : | IV : |
| WL : | QTY : |
| QC : | Date : |

9. 包装载带与圆盘尺寸: Packing tape and Disc size

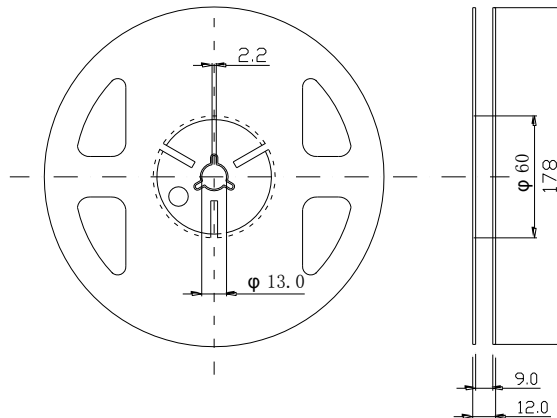

注: 1. 尺寸单位为毫米 (mm)。

Note: 1. Size in mm.

2. 尺寸公差是±0.1mm。

2. Dimensional Tolerance ±0.1mm.

3. 包装数量: 3K。

3. Package quantity: 3000PCS/Roll.

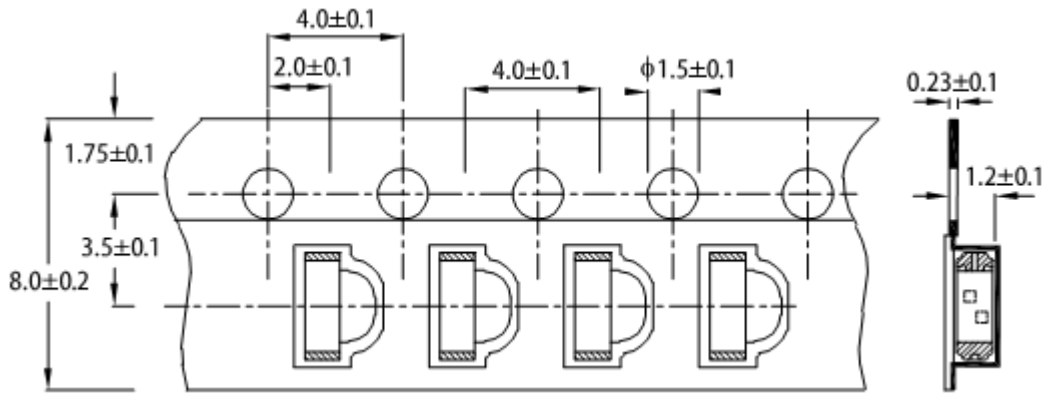

10. 圆盘及载带卷出方向及空穴规格:

Roll out direction and hole specification of disk and carrier band

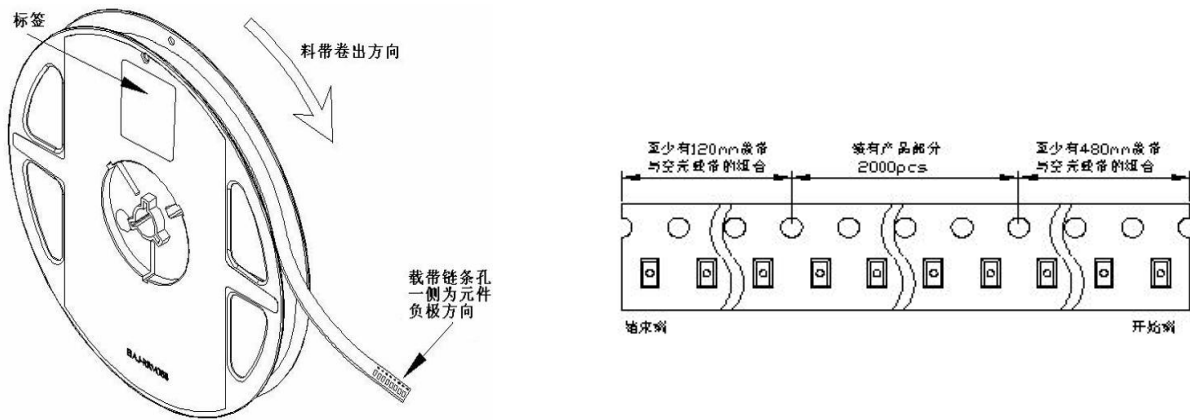

11. 内包装及外包装: Inner packing and outer packing

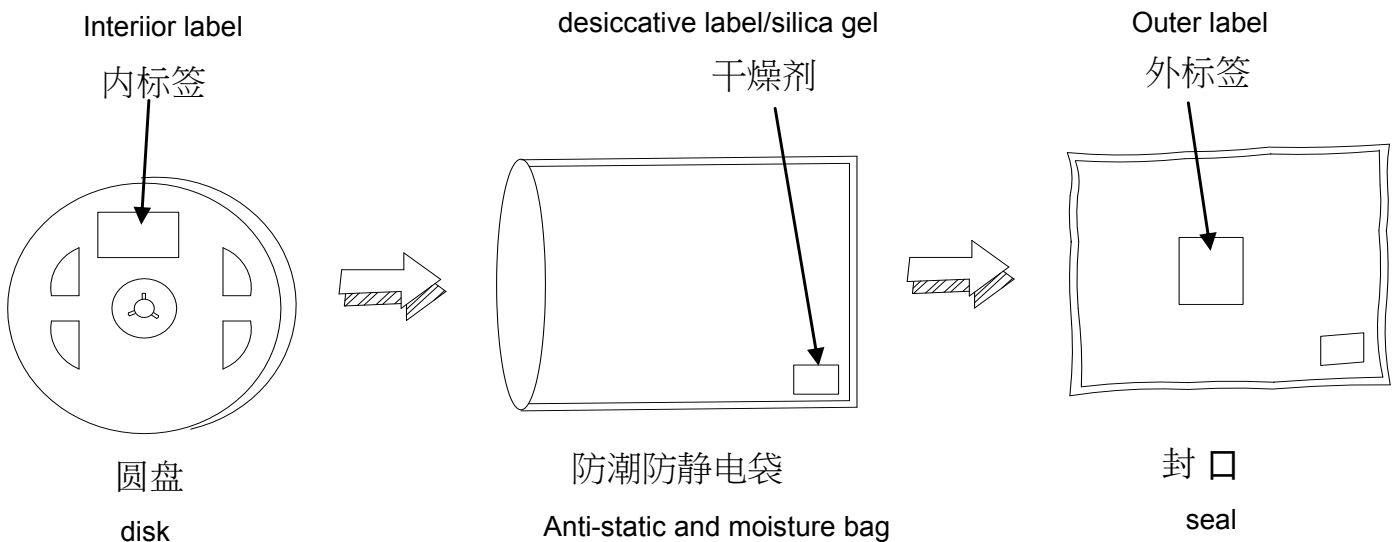

12. 信赖性实验：Reliability Test

| 类别 Classification | 测试项目 Test Item | 测试环境 Test Condition | 测试时间 Test Time | 参考标 Reference Standard |
|----------------------------|---|---|---|---|
| 耐久性测试 Endurance Test | 工作寿命 Operation Life | 室温条件下以最大额定电流持续点亮； 以 20mA 测试。 Ta= Under Room Temperature As Per Data Sheet Maximum Rating | 1000 小时 (-24 小时, +72 小时) 1000HRS (-24HRS,+72HRS) | MIL-STD-750D:1026 MIL-STD-883D:1005 JIS C 7021:B-1 |
| | 高温高湿 储存 High Temperature, High Humidity Storage | IR-Reflow In-Board, 2 Times 环境温度 Ta= 85±5℃,相对湿度 RH= 85% | 1000 小时 (± 2 小时) 1000HRS (± 2HRS) | JESD22-A101 |
| | 高温储存 High Temperature Storage | 环境温度 Ta= 105±5℃ | 1000 小时 (-24小时, +72小时) 1000HRS (-24HRS,+72HRS) | MIL-STD-883D:1008 JIS C 7021:B-10 |
| | 低温储存 Low Temperature Storage | 环境温度 Ta= -40±5℃ | 1000 小时 (-24小时, +72小时) 1000HRS (-24HRS,+72HRS) | JIS C 7021:B-12 |
| 环境测试 Environmental Test | 温度循环 Temperature Cycling | 105℃ ~ 25℃ ~ -55℃ ~ 25℃ 30mins 5mins 30mins 5mins | 10 次循环 10 Cycles | MIL-STD-202F:107D MIL-STD-750D:1051 MIL-STD-883D:1010 JIS C 7021:A-4 |
| | 冷热冲击 Thermal Shock | IR-Reflow In-Board, 2 Times 80 ± 5℃ ~ -35℃ ± 5℃ 10mins 10mins | 10 次循环 10 Cycles | MIL-STD-202F:107D MIL-STD-750D:1051 MIL-STD-883D:1011 |
| | 焊锡试验 Soldering testing | 焊锡温度 T.sol= 260 ± 5℃ | 10 ± 1secs 2 次 | MIL-STD-202F:210A MIL-STD-750D:2031 JIS C 7021:A-1 |
| | 红外回流焊 无铅制程 IR-Reflow Pb Free Process | 升温速度(217℃到最高值)：最大 3℃/秒 维持温度在 175(±25)℃：不超过 180 秒 维持温度在 217℃以上：60-150 秒 最高温度限制范围：260℃+0/-5℃ 维持在260℃+0/-5℃时间：20-40秒 降温速度：最大 6℃/秒 Ramp-up rate(217 to Peak) :3℃ / second max Temp. maintain at 175(± 25)℃ :180 seconds max Temp. maintain above 217 ℃;60 -150 seconds Peak temperature range 260 +0/ ℃ -5℃ Time within 5℃ of actual Peak Temperature (tp)20-40 seconds Ramp-down rate +6 /second max | ----- | MIL-STD-750D:2031.2 J-STD-020C |

| | | | | |
|--|-------------------------|---|---------------|---|
| | 可焊性试验 Solder-ability | 焊锡温度 T.sol= 235 ± 5℃ 浸入速度: 25±2.5 mm/秒 上锡率 ≥95% 焊盘面积 T.sol= 235 ± 5℃ Immersion rate 25±2.5 mm/sec Coverage 95% of the dipped surface | 浸入时间: 2±0.5 秒 | MIL-STD-202F:208D MIL-STD-750D:2026 MIL-STD-883D:2003 IEC 68 Part 2-20 JIS C 7021:A-2 |
|--|-------------------------|---|---------------|---|

13、使用注意事项：Caution

a. 使用 using

1. LED 是电流驱动元件，电压的细微变化会产生较大的电流波动,导致元件遭到破坏。客户应使用电阻串联作限流保护。

1.LED is a current-operated device. The slight shift of voltage will cause big change of current, which will damage LEDs. Customer should use resistors in series for the Over-Current-Proof.

2. 为了确保多颗 LED 并联使用时光色一致，建议每条支路使用单独电阻,如下图模式 A 所示；如采用下图模式 B 所示电路，LED 光色可能因每一颗 LED 不同的伏安特性而造成光色差异。

2. In order to ensure consistent light-color on multiple LEDs connected in parallel, individual resistor separately is suggested, as Circuit A below shown. If the light-color of each LED shown as Circuit B might be difference due to the different I-V characteristics of each LED.

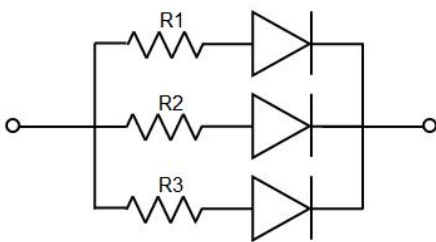

电路模式 A
Circuit model A

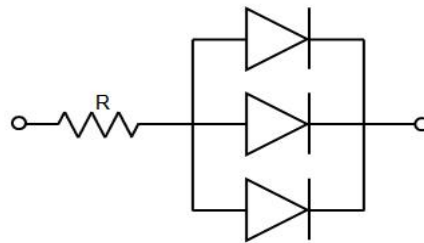

电路模式 B
Circuit model B

3. 过高的环境温度会影响 LED 的亮度以及其他性能，所以为能使 LED 有较好的性能表现应远离热源。

3. Too high ambient temperature will affect the brightness of LED and its properties, please be away from the heat so as to keep performance better.

存储: storage

1. 未打开原始包装的情况下, 建议储存的环境为: 温度: 5°C~30°C; 湿度:60%RH 以下,当库存超过 2 个月, 使用前应做除湿处理。条件 60°C /12 小时。
1.The recommended storage before unpacking: Temperature :5°C~30°C; Humidity :below 60% RH. Dehumidification should be done before use when it stored for more than 2 months. Conditions 60°C/12 hours.
2. 打开原始包装后, 建议储存环境为: 温度 5~30°C ; 湿度 30%RH 以下。
2.The suggested storage requirement should be temperature in 5~30°C,humidity below 30% RH.after open the package.
3. LED 是湿度敏感元件, 为避免元件吸湿, 建议打开包装后, 将其储存在有干燥剂的密闭容器内, 或者储存在氮气防潮柜内。
3. LED is a component that is sensitive to humidity,which requires to be stored in sealed container with desiccant or nitrogen moisture-proof cabinet to avoid moisture absorption after unpacking.
4. 此款灯珠防潮等级为 MSL3; 打开包装后, 元件应该在 168 小时 (7 天) 使用; 且贴片后应尽快做焊接。
4.The moisture-proof level of LED is MSL3. Component should be used in 168hrs(7 days) after unpacking and be welded as soon as possible.
5. 如果干燥剂失效或者元件暴露于空气中超过 168 小时 (7 天), 应作除湿处理。
5.Component should be dehumidified when it is exposed to the air for more than168hrs(7days) or desiccant expired.

ESD 静电防护 Electrostatic Protection

LED (特别是 InGaN 结构的蓝色、翠绿色、紫色、白色、粉红色 LED) 是静电敏感元件, 静电或者电流过载会破坏 LED 结构。LED 受到静电伤害或电流过载可能会导致性能异常, 比如漏电流过大, VF 变低, 或者无法点亮等等。所以请注意以下事项:

Due to LED(especially the blue, yellow green, purple, white, pink LED in InGaN structure) is sensitive to electrostatic that would damage to its structure,which may perform abnormal after being attacked by electrostatic or overload current,such as excessive leakage current, low VF or unable illumination, please mind as below.

- 1.接触 LED 时应佩戴防静电腕带或者防静电手套。
1.Anti-static wristband or anti-static gloves should be worn to touch LED.
- 2.所有的机器设备、工制具、工作桌、料架等等，应该做适当的接地保护（接地阻抗值 10Ω 以内）。
2.rounding protection should be done for all machinery and equipment tools, work tables, material racks, etc..(within 10Ω of grounding impedance).
3. 储存或搬运 LED 应使用防静电料袋、防静电盒以及防静电周转箱，严禁使用普通塑料制品。
3.Anti-static bag, anti-static box and anti-static turnover box should be used for storage or transportation. Never used plastic.
4. 建议在作业过程中，使用离子风扇来压制静电的产生。
4.It is recommended to use ion fan to suppress electrostatic generation during operation.
5. 距离 LED 元件 1 英尺距离的环境范围内静电场电压小于 100V。
5.The Voltage of static field is less than 100V in 1 foot radius from LED component.

清洗 clean

建议使用异丙醇等醇类溶液清洗 LED，严禁使用腐蚀性溶液清洗。

Recommend using isopropanol and other alcohol solvent rather than corrosive solution to clean LED.

焊接 welding

1. 回流焊焊接条件参考第一页温度曲线。
1.Reflow welding conditions refer to the first page temperature curve.
2. 回流焊焊接次数不得超过两次。
2.Reflux welding shall be less twice.
3. 只建议在修理和重工的情况下使用手工焊接；最高焊接温度不应超过 300 度，且须在 3 秒内完成。烙铁最大功率应不超过 30W。
3.Manual welding is only recommended for repairing and reworking; Finish the welding in 3 Seconds, 300°C maximum welding temperture.The maximum power of hot iron should be less 30w.
4. 焊接过程中,严禁在高温情况下碰触胶体。
4. It is strictly forbidden to touch colloid at high temperature during the process of welding.
5. 焊接后，禁止对胶体施加外力，禁止弯折 PCB，避免元件受到撞击。
5. Do not force to the colloid and bend PCB to avoid components being hit after welding.

其他 **other**

1. 本规格所描述的 LED 定义应用在普通的电子设备范围（例如办公设备、通讯设备等等）。如果有更为严苛的信赖度要求，特别是当元件失效或故障时可能会直接危害到生命和健康时（如航天、运输、交通、医疗器械、安全保护等等），请事先知会敝司业务人员。
1. The definition of LED in this specification shall be applied to electronic equipments (e.g. office equipment, communication equipment, etc). If more stringent reliability is required, especially when components fail or broken, which may directly endanger life and health (such as aerospace, transportation, traffic, medical devices, safety protection, etc.), please inform our salesperson in advance.
2. 高亮度 LED 产品点亮时可能会对人眼造成伤害，应避免从正上方直视。
2.High brightness of LED product may damage to human eyes, should avoid looking straight from the top.
3. 出于持续改善的目的，产品外观和参数规格可能会在没有预先通知的情况下作改良性变化。
3.The specification of the products appearance and parameter may be modified without prior notice for continuous improvement.