

## Features

- \* Transient protection for high-speed data lines
  - IEC 61000-4-2 (ESD)  $\pm 30\text{kV}$  (Air)
  - $\pm 30\text{kV}$  (Contact)
  - IEC 61000-4-4 (EFT) 40A (5/50 ns)
  - IEC 61000-4-5 (Surge) 10A (8/20 $\mu\text{s}$ )
- \* Package optimized for high-speed lines
- \* Provides protection for two line pairs
- \* Low capacitance: 4.5pF @ 2.5V (Typical)
- \* Low leakage current: 10nA @  $V_{RWM}$  (Typical)
- \* Low operating and clamping voltage
- \* Each I/O pin can withstand over 1000 ESD strikes for  $\pm 8\text{kV}$  contact discharge

## Mechanical Characteristics

- \* Package: DFN-8L package
- \* Lead Finish: Matte Tin
- \* Case Material: “Green” Molding Compound.
- \* UL Flammability Classification Rating 94V-0
- \* Moisture Sensitivity: Level 3 per J-STD-020
- \* Terminal Connections: See Diagram Below

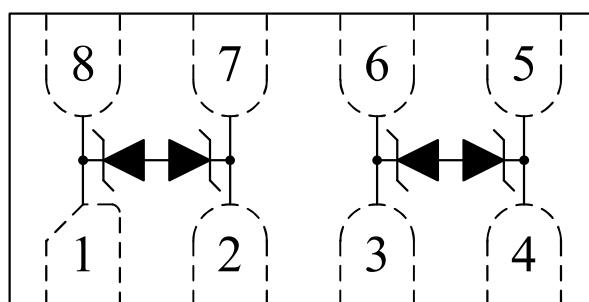
## Applications

- \* 10/100/1000M Ethernet Ports
- \* WAN/LAN Equipment
- \* Desktops, Servers and Notebooks
- \* Switching Systems

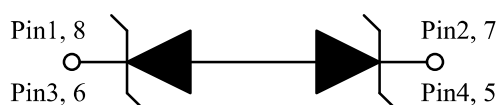
## Ordering Information

Part Number	Qty per Reel	Reel Size
TPE2203-25	3000	7"

## Dimensions and Pin Configuration



DFN-8L  
(Top View)



**Absolute Maximum Ratings ( $T_A=25^\circ\text{C}$  unless otherwise specified)**

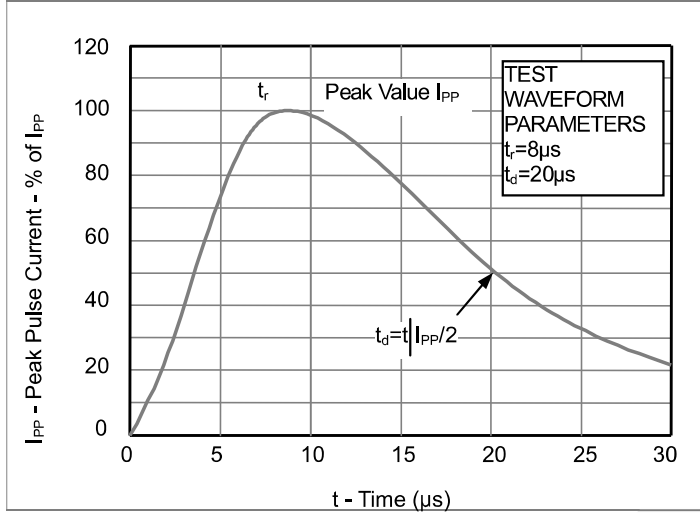
Parameter	Symbol	Value	Unit
Peak Pulse Power (8/20 $\mu\text{s}$ )	Ppk	100	W
Peak Pulse Current (8/20 $\mu\text{s}$ )	IPP	10	A
ESD per IEC 61000-4-2 (Air)	VESD	$\pm 30$	kV
ESD per IEC 61000-4-2 (Contact)		$\pm 30$	
Operating Temperature Range	TJ	-40 to +85	$^\circ\text{C}$
Storage Temperature Range	Tstg	-55 to +150	$^\circ\text{C}$

**Electrical Characteristics ( $T_A=25^\circ\text{C}$  unless otherwise specified)**

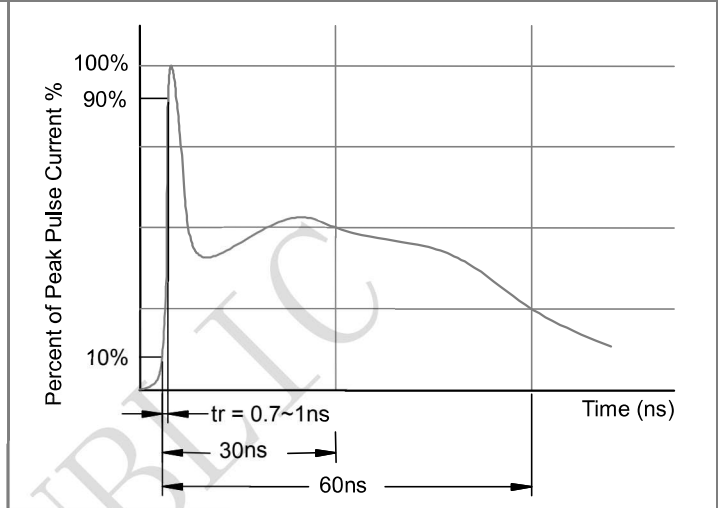
Parameter	Symbol	Test Condition	Min	Typ	Max	Unit
Reverse Working Voltage	V <sub>RWM</sub>				2.5	V
Breakdown Voltage	V <sub>BR</sub>	I <sub>T</sub> = 1mA	3.0		4.5	V
Reverse Leakage Current	I <sub>R</sub>	V <sub>RWM</sub> = 2.5V			0.04	$\mu\text{A}$
Clamping Voltage	V <sub>C</sub>	I <sub>PP</sub> = 2A (8 x 20 $\mu\text{s}$ pulse)			5	V
Clamping Voltage	V <sub>C</sub>	I <sub>PP</sub> = 10A (8 x 20 $\mu\text{s}$ pulse)			9	V
Junction Capacitance	C <sub>J</sub>	V <sub>R</sub> = 2.5V, f = 1MHz (Each Line)		4.5		pF
Junction Capacitance	C <sub>J</sub>	Pin1, 8 to 2, 7 & Pin3, 6 to Pin4, 5 V <sub>R</sub> = 0V ~ 2.5V, f = 1MHz		1.5		pF

**Typical Performance Characteristics (TA=25°C unless otherwise Specified)**

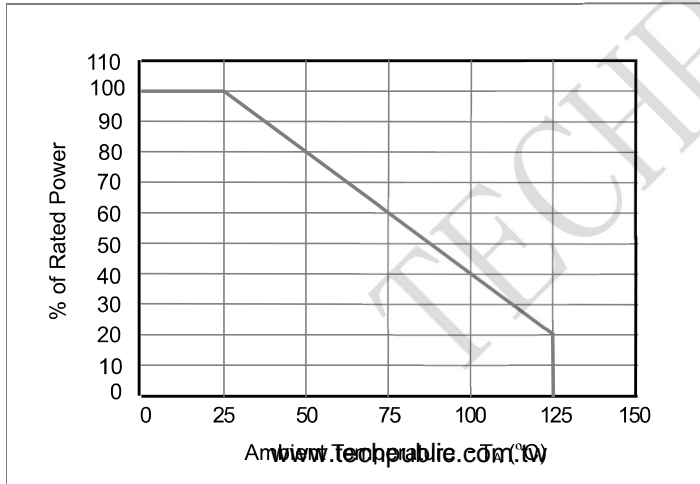
**Fig1. 8/20 $\mu$ s Pulse Waveform**



**Fig2. ESD Pulse Waveform (according to IEC 61000-4-2)**

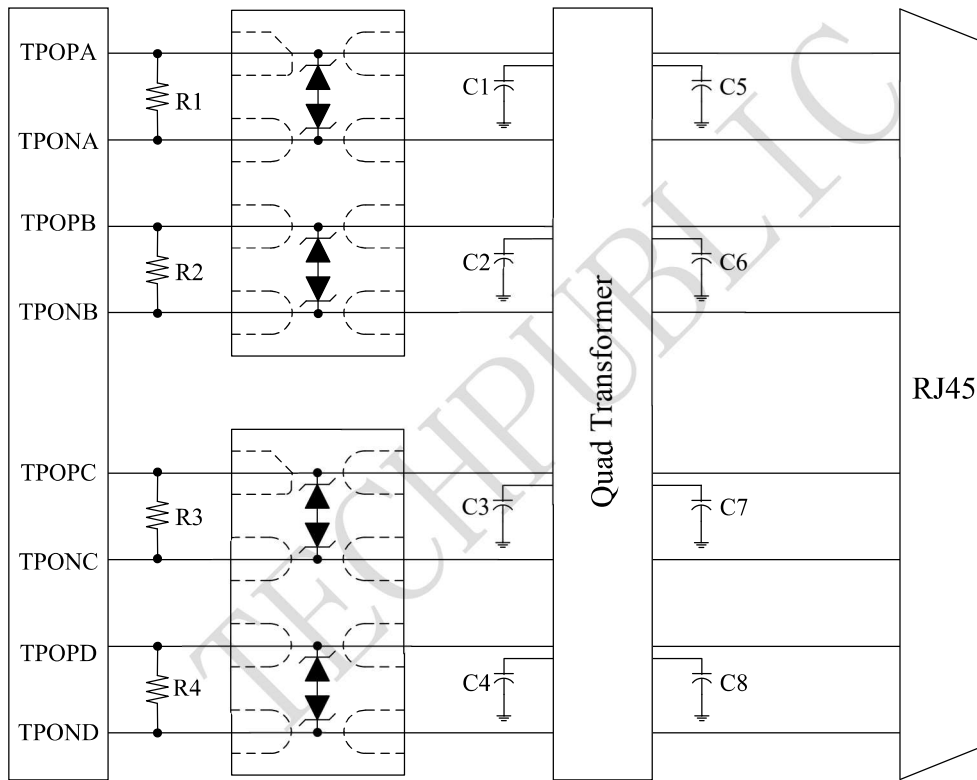


**Fig3. Power Derating Curve**



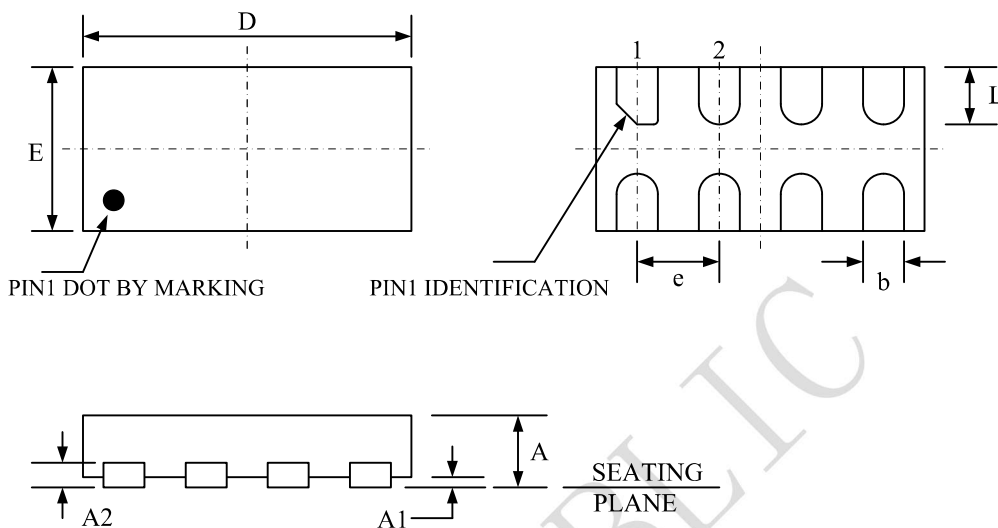
### Application Information

Electronic equipment is susceptible to damage caused by a variety of sources, including Electrostatic Discharge (ESD), Electrical Fast Transients (EFT) and Lightning strikes. The TP2203-25 was designed to protect the sensitive equipment from damage which may be induced by such transient events. This product can be configured in a connection to meet the requirement of differential line pairs as follows:



Schematic Diagram for Gigabit Ethernet ESD/Surge Protection

**DFN-8 Package Outline Drawing**



Package Dimensions (Controlling dimensions are in millimeters)

Symbol	Dimensions (mm)			Dimensions (Inches)		
	Minimum	Typical	Maximum	Minimum	Typical	Maximum
A	0.370	0.400	0.430	0.015	0.016	0.017
A1	0.000	0.020	0.050	0.000	0.001	0.002
A2	0.130			0.005		
b	0.200	0.250	0.300	0.008	0.010	0.012
D	1.900	2.000	2.100	0.075	0.079	0.083
E	0.900	1.000	1.100	0.035	0.039	0.043
e	0.500 BSC			0.020 BSC		
L	0.300	0.350	0.400	0.012	0.014	0.016
R	0.050	0.100	0.150	0.002	0.004	0.006