

Features

- * 300W peak pulse power (8/20 μ s)
- * Protects one data or power line
- * Ultra low leakage: nA level
- * Operating voltage: 5V
- * Ultra low clamping voltage
- * Complies with following standards:
 - IEC 61000-4-2 (ESD) immunity test
 - Air discharge: ± 30 kV
 - Contact discharge: ± 30 kV
 - IEC61000-4-4 (Lightning) 20A (8/20ns)

Mechanical Characteristics

- * Package: SOD-323
- * Lead Finish: Matte Tin
- * Case Material: "Green" Molding Compound.
- * UL Flammability Classification Rating 94V-0
- * Moisture Sensitivity: Level 3 per J-STD-020
- * Terminal Connections: See Diagram Below

Applications

- * Cellular Handsets and Accessories
- * Personal Digital Assistants
- * Notebooks and Handhelds
- * Portable Instrumentation
- * Peripherals
- * Pagers Peripherals
- * Desktop and Servers

Ordering Information

Part Number	Qty per Reel	Reel Size
D5V0L1B2WS-TP	3000	7"

Dimensions and Pin Configuration

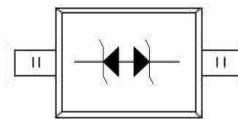

Marking: 2B

Absolute Maximum Ratings (Tamb=25°C unless otherwise specified)

Parameter	Symbol	Value	Unit
Peak Pulse Power (8/20μs)	Ppk	300	W
Peak Pulse Current (8/20μs)	IPP	20	A
ESD per IEC 61000-4-2 (Air)	VESD	±30	kV
ESD per IEC 61000-4-2 (Contact)		±30	
Operating Temperature Range	TJ	-55 to +125	°C
Storage Temperature Range	Tstg	-55 to +150	°C

Electrical Characteristics (TA=25°C unless otherwise specified)

Symbol	Parameter
V _{RWM}	Nominal Reverse Working Voltage
I _R	Reverse Leakage Current @ V _{RWM}
V _{BR}	Reverse Breakdown Voltage @ I _T
I _T	Test Current for Reverse Breakdown
V _C	Clamping Voltage @ I _{PP}
I _{PP}	Maximum Peak Pulse Current
C _{ESD}	Parasitic Capacitance
V _R	Reverse Voltage
f	Small Signal Frequency

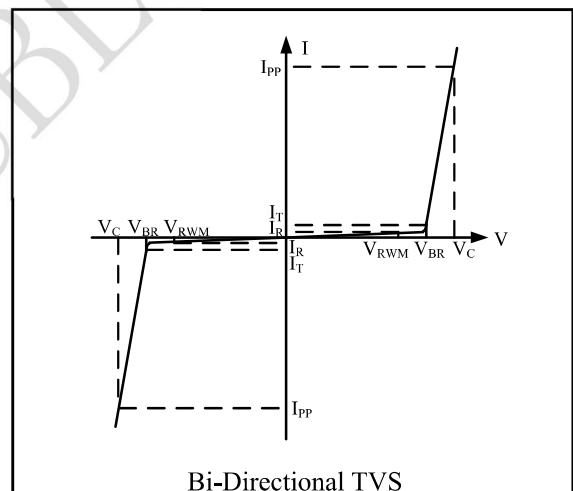

Parameter	Symbol	Test Condition	Min	Typ	Max	Unit
Reverse Working Voltage	V _{RWM}				5	V
Breakdown Voltage	V _{BR}	I _T = 1mA(Pin1-Pin2)	6.0	7.0	8.0	V
Reverse Leakage Current	I _R	V _{RWM} = 5.0V(Pin2-Pin1)			0.1	μA
Clamping Voltage	V _C	I _{PP} = 10A (8 x 20μs pulse) (Pin1-Pin2)		7.0		V
Clamping Voltage	V _C	I _{PP} = 20A (8 x 20μs pulse) (Pin1-Pin2)		9.0		V
Junction Capacitance	C _J	V _R = 0V, f = 1MHz (Pin1-Pin2)		35		pF

Characteristic Curves

Fig1. 8/20 μ s Pulse Waveform

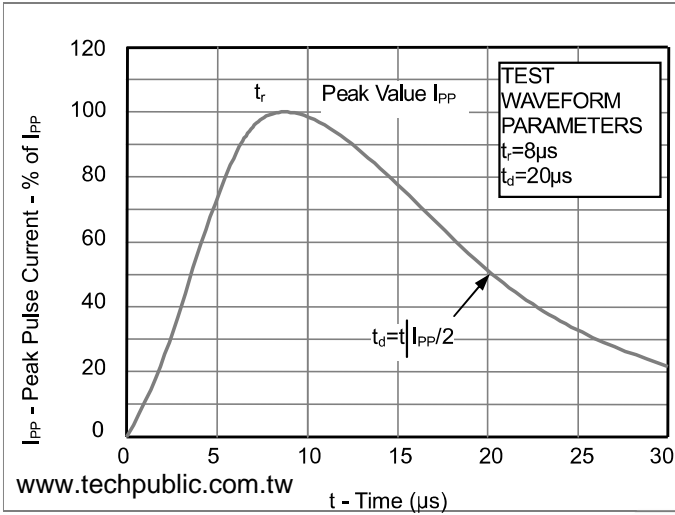

Fig2. ESD Pulse Waveform (according to IEC 61000-4-2)

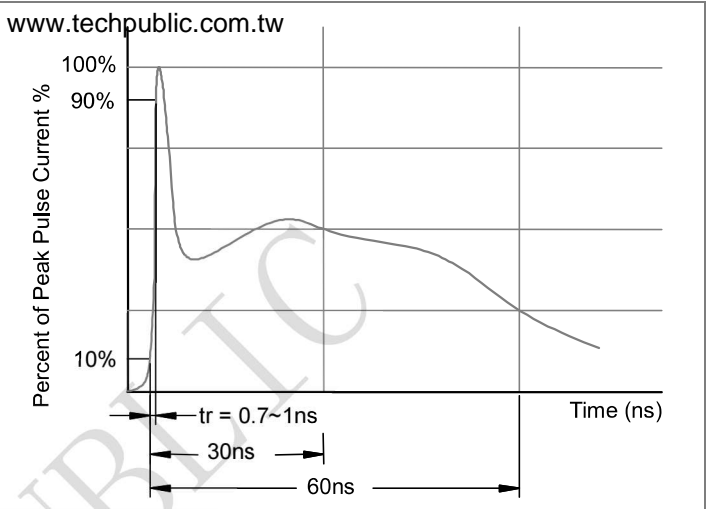
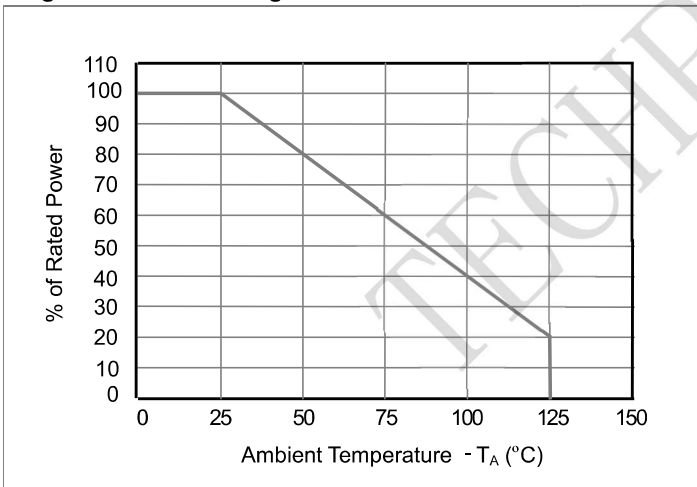
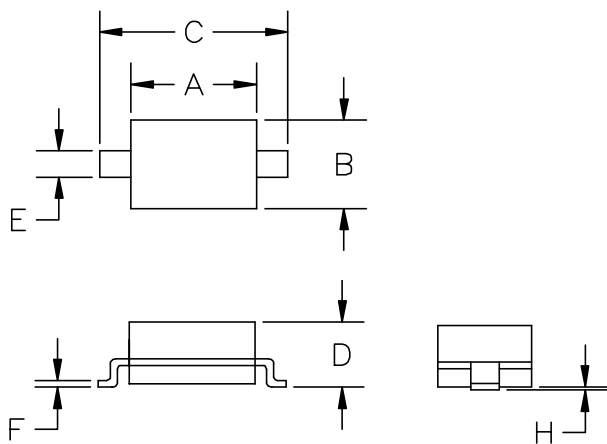

Fig3. Power Derating Curve



Outline Drawing - SOD-323



SYM	DIMENSIONS			
	MILLIMETERS		INCHES	
	MIN	MAX	MIN	MAX
A	1.50	1.80	0.060	0.071
B	1.20	1.40	0.045	0.054
C	2.30	2.70	0.090	0.107
D	-	1.10	-	0.043
E	0.30	0.40	0.012	0.016
F	0.10	0.25	0.004	0.010
H	-	0.10	-	0.004

Land Pattern - SOD-323

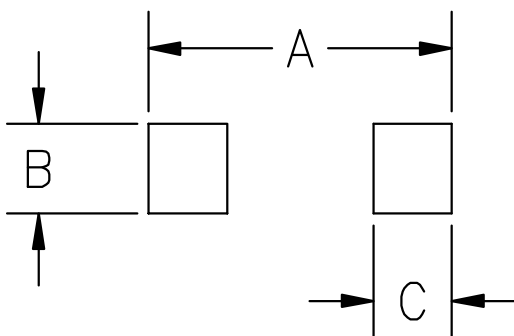

SYM	DIMENSIONS	
	MILLIMETERS	INCHES
A	3.15	0.120
B	0.80	0.031
C	0.80	0.031