

### Description

The HSL6107 is the high cell density trenched P-ch MOSFETs, which provide excellent R<sub>DS(on)</sub> and gate charge for most of the synchronous buck converter applications.

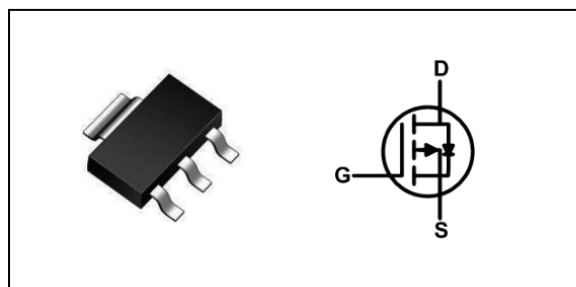
The HSL6107 meet the RoHS and Green Product requirement, 100% EAS guaranteed with full function reliability approved.

- 100% EAS Guaranteed
- Green Device Available
- Super Low Gate Charge
- Excellent CdV/dt effect decline
- Advanced high cell density Trench technology

### Product Summary

V <sub>DS</sub>	-60	V
R <sub>DS(ON),max</sub>	180	mΩ
I <sub>D</sub>	-2.3	A

### SOT223 Pin Configuration



### Absolute Maximum Ratings

Symbol	Parameter	Rating	Units
V <sub>DS</sub>	Drain-Source Voltage	-60	V
V <sub>GS</sub>	Gate-Source Voltage	±20	V
I <sub>D</sub> @T <sub>A</sub> =25°C	Continuous Drain Current, V <sub>GS</sub> @ -10V <sub>1</sub>	-2.3	A
I <sub>D</sub> @T <sub>A</sub> =70°C	Continuous Drain Current, V <sub>GS</sub> @ -10V <sub>1</sub>	-1.9	A
I <sub>DM</sub>	Pulsed Drain Current <sub>2</sub>	-12	A
EAS	Single Pulse Avalanche Energy <sub>3</sub>	11.7	mJ
I <sub>AS</sub>	Avalanche Current	-15.3	A
P <sub>D</sub> @T <sub>A</sub> =25°C	Total Power Dissipation <sub>4</sub>	1.5	W
T <sub>STG</sub>	Storage Temperature Range	-55 to 150	°C
T <sub>J</sub>	Operating Junction Temperature Range	-55 to 150	°C

### Thermal Data

Symbol	Parameter	Typ.	Max.	Unit
R <sub>θJA</sub>	Thermal Resistance Junction-Ambient <sub>1</sub>	---	85	°C/W
R <sub>θJC</sub>	Thermal Resistance Junction-Case <sub>1</sub>	---	48	°C/W

**Electrical Characteristics (T<sub>J</sub>=25 °C, unless otherwise noted)**

Symbol	Parameter	Conditions	Min.	Typ.	Max.	Unit
B <sub>VDS</sub>	Drain-Source Breakdown Voltage	V <sub>GS</sub> =0V, I <sub>D</sub> =-250uA	-60	---	---	V
ΔB <sub>VDS</sub> /ΔT <sub>J</sub>	B <sub>VDS</sub> Temperature Coefficient	Reference to 25°C, I <sub>D</sub> =-1mA	---	-0.021	---	V/°C
R <sub>DS(ON)</sub>	Static Drain-Source On-Resistance <sup>2</sup>	V <sub>GS</sub> =-10V, I <sub>D</sub> =-2A	---	140	180	mΩ
		V <sub>GS</sub> =-4.5V, I <sub>D</sub> =-1.5A	---	200	260	
V <sub>GS(th)</sub>	Gate Threshold Voltage	V <sub>GS</sub> =V <sub>DS</sub> , I <sub>D</sub> =-250uA	-1.0	---	-2.5	V
ΔV <sub>GS(th)</sub>	V <sub>GS(th)</sub> Temperature Coefficient		---	4.08	---	mV/°C
I <sub>DSS</sub>	Drain-Source Leakage Current	V <sub>DS</sub> =-48V, V <sub>GS</sub> =0V, T <sub>J</sub> =25°C	---	---	1	uA
		V <sub>DS</sub> =-48V, V <sub>GS</sub> =0V, T <sub>J</sub> =55°C	---	---	5	
I <sub>GSS</sub>	Gate-Source Leakage Current	V <sub>GS</sub> =±20V, V <sub>DS</sub> =0V	---	---	±100	nA
g <sub>fs</sub>	Forward Transconductance	V <sub>DS</sub> =-10V, I <sub>D</sub> =-2A	---	6.3	---	S
Q <sub>g</sub>	Total Gate Charge (-4.5V)	V <sub>DS</sub> =-20V, V <sub>GS</sub> =-4.5V, I <sub>D</sub> =-2A	---	4.6	---	nC
Q <sub>gs</sub>	Gate-Source Charge		---	1.4	---	
Q <sub>gd</sub>	Gate-Drain Charge		---	1.62	---	
T <sub>d(on)</sub>	Turn-On Delay Time	V <sub>DS</sub> =-15V, V <sub>GS</sub> =-10V, R <sub>G</sub> =3.3Ω, I <sub>D</sub> =-1A	---	17.4	---	ns
T <sub>r</sub>	Rise Time		---	5.4	---	
T <sub>d(off)</sub>	Turn-Off Delay Time		---	37.2	---	
T <sub>f</sub>	Fall Time		---	2.4	---	
C <sub>iss</sub>	Input Capacitance	V <sub>DS</sub> =-15V, V <sub>GS</sub> =0V, f=1MHz	---	531	---	pF
C <sub>oss</sub>	Output Capacitance		---	59	---	
C <sub>rss</sub>	Reverse Transfer Capacitance		---	38	---	

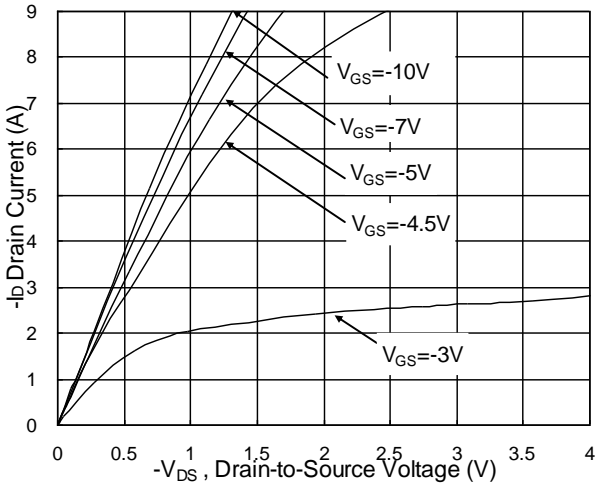
**Diode Characteristics**

Symbol	Parameter	Conditions	Min.	Typ.	Max.	Unit
I <sub>S</sub>	Continuous Source Current <sup>1,5</sup>	V <sub>G</sub> =V <sub>D</sub> =0V, Force Current	---	---	-2.3	A
I <sub>SM</sub>	Pulsed Source Current <sup>2,5</sup>		---	---	-12	A
V <sub>SD</sub>	Diode Forward Voltage <sup>2</sup>	V <sub>GS</sub> =0V, I <sub>S</sub> =-1A, T <sub>J</sub> =25°C	---	---	-1.2	V

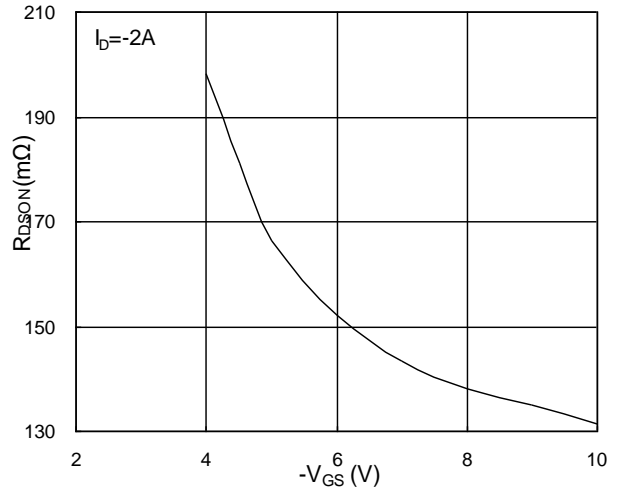
Note :

- 1.The data tested by surface mounted on a 1 inch<sup>2</sup> FR-4 board with 2OZ copper.
- 2.The data tested by pulsed , pulse width ≤ 300us , duty cycle ≤ 2%
- 3.The EAS data shows Max. rating . The test condition is V<sub>DD</sub>=-25V, V<sub>GS</sub>=-10V, L=0.1mH, I<sub>AS</sub>=-15.3A
- 4.The power dissipation is limited by 150°C junction temperature
- 5.The data is theoretically the same as I<sub>D</sub> and I<sub>DM</sub> , in real applications , should be limited by total power dissipation.

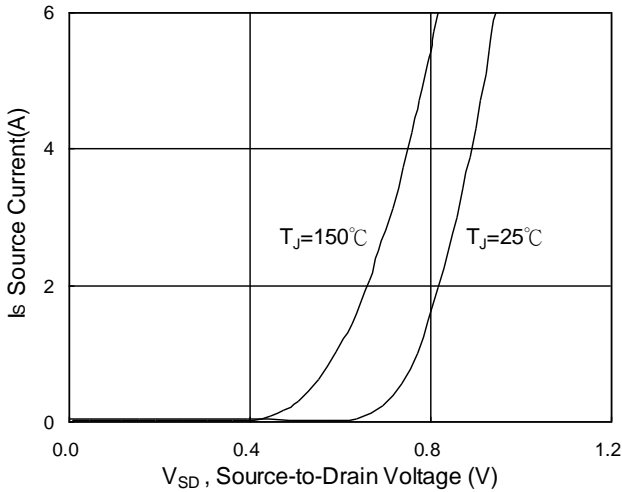
**Typical Characteristics**



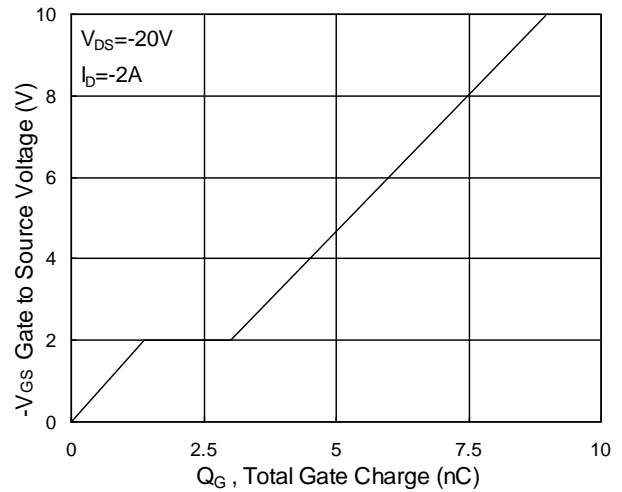
**Fig.1 Typical Output Characteristics**



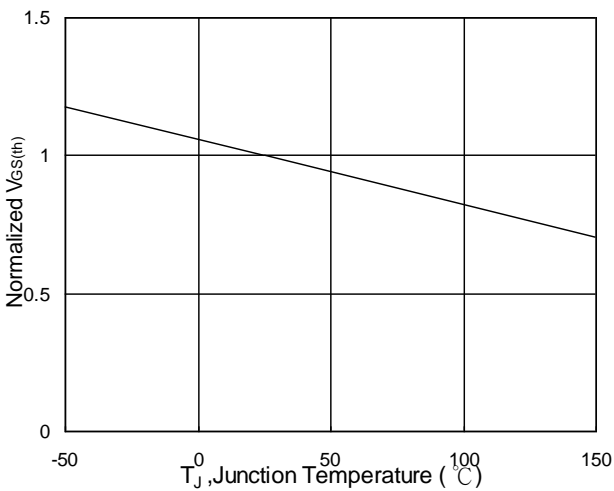
**Fig.2 On-Resistance v.s Gate-Source**



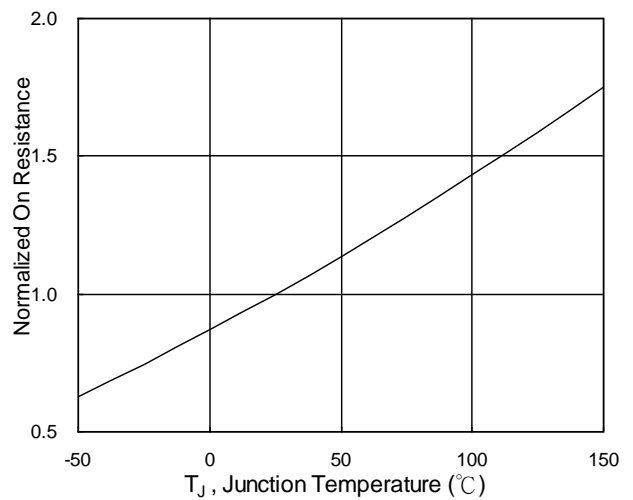
**Fig.3 Forward characteristics of reverse**



**Fig.4 Gate-charge characteristics**

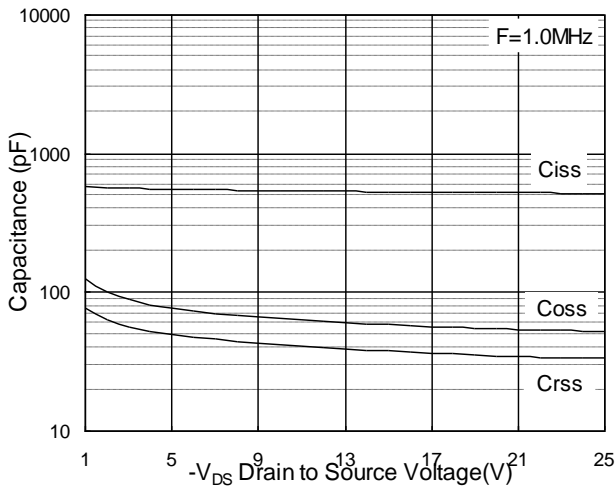


**Fig.5 Normalized  $V_{GS(th)}$  v.s  $T_J$**

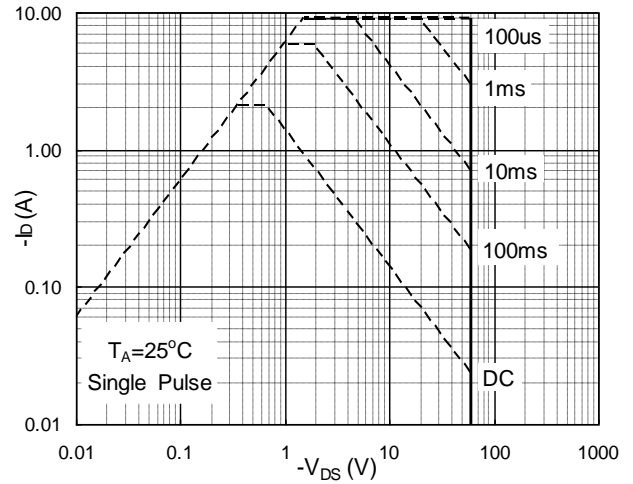


**Fig.6 Normalized  $R_{DS(on)}$  v.s  $T_J$**

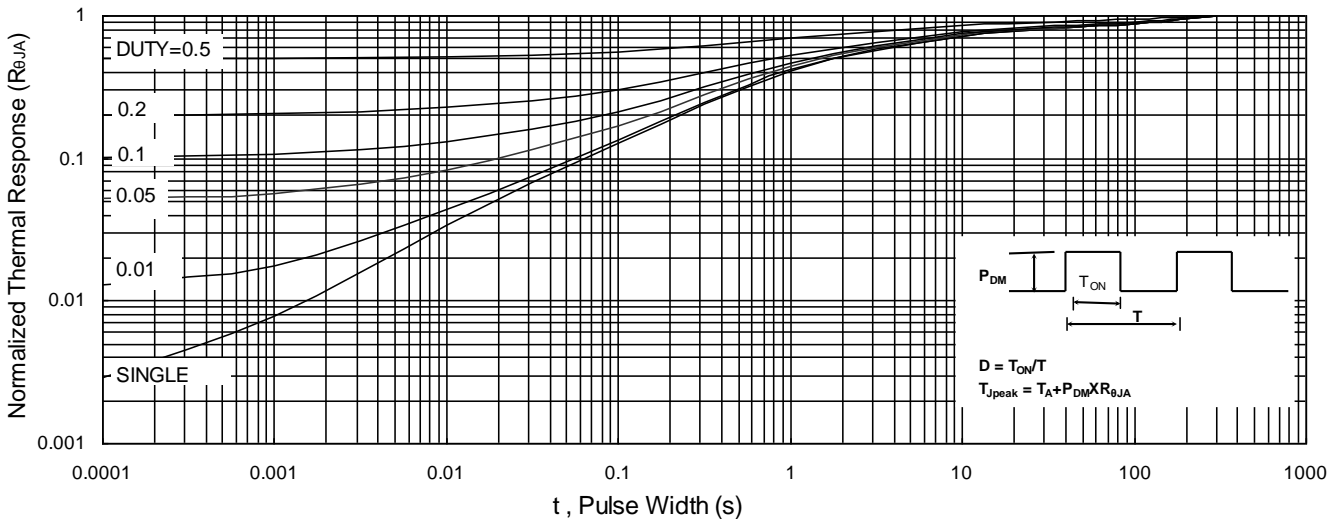
**P-Ch 60V Fast Switching MOSFETs**



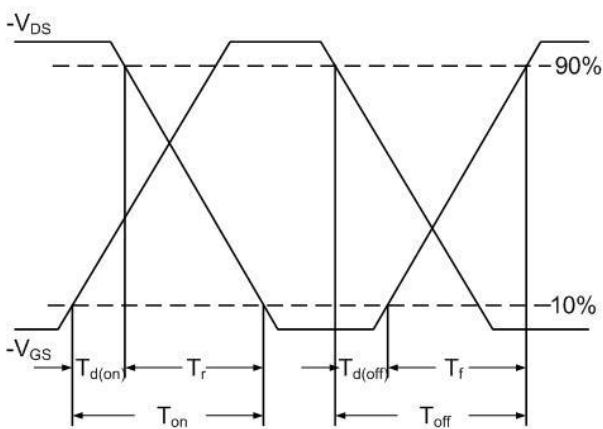
**Fig.7 Capacitance**



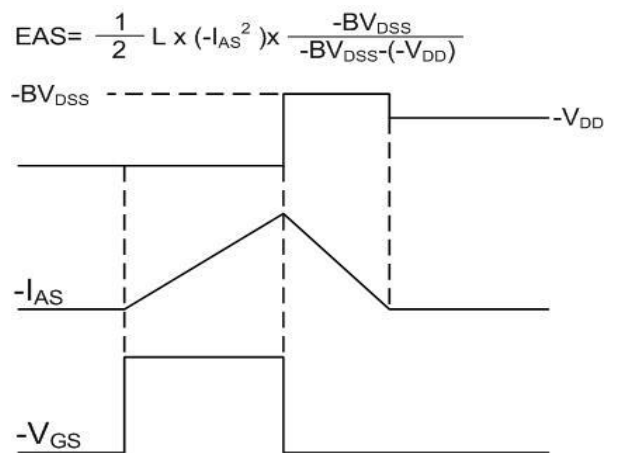
**Fig.8 Safe Operating Area**



**Fig.9 Normalized Maximum Transient Thermal Impedance**



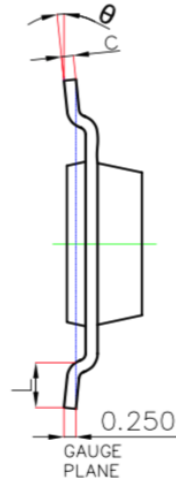
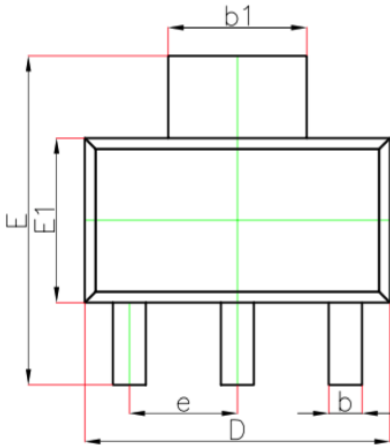
**Fig.10 Switching Time Waveform**



**Fig.11 Unclamped Inductive Switching**

## Ordering Information

Part Number	Package code	Packaging
HSL6107	SOT-223	3000/Tape&Reel



Symbol	Dimensions In Millimeters		Dimensions In Inches	
	Min.	Max.	Min.	Max.
A	—	1.800	—	0.071
A1	0.020	0.100	0.001	0.004
A2	1.500	1.700	0.059	0.067
b	0.660	0.840	0.026	0.033
b1	2.900	3.100	0.114	0.122
c	0.230	0.350	0.009	0.014
D	6.300	6.700	0.248	0.264
E	6.700	7.300	0.264	0.287
E1	3.300	3.700	0.130	0.146
e	2.300(BSC)		0.091(BSC)	
L	0.750	—	0.030	—
θ	0°	10°	0°	10°