

**N-Ch 60V Fast Switching MOSFETs**
**Description**

- Advanced Trench MOS Technology
- Low Gate Charge
- Low  $R_{DS(ON)}$
- 100% EAS Guaranteed
- Green Device Available

**Product Summary**

$V_{DS}$	60	V
$R_{DS(ON),typ}$	4.4	m $\Omega$
$I_D$	78	A

**Application**

- Motor Control.
- DC/DC Converter.
- Synchronous rectifier applications.

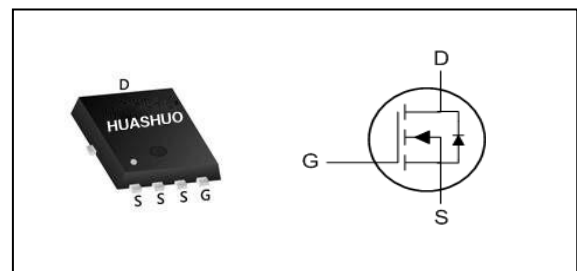
**PRPAK5X6 Pin Configuration**

**Absolute Maximum Ratings**

Symbol	Parameter	Rating	Units
$V_{DS}$	Drain-Source Voltage	60	V
$V_{GS}$	Gate-Source Voltage	$\pm 20$	V
$I_D@T_C=25^\circ C$	Continuous Drain Current <sup>1</sup>	78	A
$I_D@T_C=100^\circ C$	Continuous Drain Current <sup>1</sup>	57	A
$I_{DM}$	Pulsed Drain Current <sup>2</sup>	210	A
EAS	Single Pulse Avalanche Energy <sup>3</sup>	93	mJ
$I_{AS}$	Avalanche Current	43	A
$P_D@T_C=25^\circ C$	Total Power Dissipation <sup>4</sup>	75	W
$T_{STG}$	Storage Temperature Range	-55 to 150	$^\circ C$
$T_J$	Operating Junction Temperature Range	-55 to 150	$^\circ C$

**Thermal Data**

Symbol	Parameter	Typ.	Max.	Unit
$R_{\theta JA}$	Thermal Resistance Junction-Ambient <sup>1</sup>	---	55	$^\circ C/W$
$R_{\theta JC}$	Thermal Resistance Junction-Case <sup>1</sup>	---	1.8	$^\circ C/W$

**N-Ch 60V Fast Switching MOSFETs**
**Electrical Characteristics (T<sub>J</sub>=25 °C, unless otherwise noted)**

Symbol	Parameter	Conditions	Min.	Typ.	Max.	Unit
B <sub>V</sub> DSS	Drain-Source Breakdown Voltage	V <sub>GS</sub> =0V, I <sub>D</sub> =250uA	60	---	---	V
R <sub>DS(ON)</sub>	Static Drain-Source On-Resistance <sup>2</sup>	V <sub>GS</sub> =10V, I <sub>D</sub> =30A	---	4.4	5.2	mΩ
		V <sub>GS</sub> =4.5V, I <sub>D</sub> =20A	---	6.4	7.8	
V <sub>GS(th)</sub>	Gate Threshold Voltage	V <sub>GS</sub> =V <sub>DS</sub> , I <sub>D</sub> =250uA	1.2	1.65	2.3	V
I <sub>DSS</sub>	Drain-Source Leakage Current	V <sub>DS</sub> =48V, V <sub>GS</sub> =0V, T <sub>J</sub> =25°C	---	---	1	uA
		V <sub>DS</sub> =48V, V <sub>GS</sub> =0V, T <sub>J</sub> =55°C	---	---	5	
I <sub>GSS</sub>	Gate-Source Leakage Current	V <sub>GS</sub> =±20V, V <sub>DS</sub> =0V	---	---	±100	nA
R <sub>g</sub>	Gate Resistance	V <sub>DS</sub> =0V, V <sub>GS</sub> =0V, f=1MHz	---	1.3	---	Ω
Q <sub>g</sub>	Total Gate Charge (4.5V)	V <sub>DS</sub> =30V, V <sub>GS</sub> =10V, I <sub>D</sub> =20A	---	33	---	nC
Q <sub>gs</sub>	Gate-Source Charge		---	18	---	
Q <sub>gd</sub>	Gate-Drain Charge		---	6	---	
T <sub>d(on)</sub>	Turn-On Delay Time	V <sub>DD</sub> =30V, V <sub>GS</sub> =10V, R <sub>G</sub> =3.3Ω, I <sub>D</sub> =20A	---	7.5	---	ns
T <sub>r</sub>	Rise Time		---	6	---	
T <sub>d(off)</sub>	Turn-Off Delay Time		---	29	---	
T <sub>f</sub>	Fall Time		---	7.5	---	
C <sub>iss</sub>	Input Capacitance	V <sub>DS</sub> =30V, V <sub>GS</sub> =0V, f=1MHz	---	1670	---	pF
C <sub>oss</sub>	Output Capacitance		---	438	---	
C <sub>rss</sub>	Reverse Transfer Capacitance		---	25	---	

**Diode Characteristics**

Symbol	Parameter	Conditions	Min.	Typ.	Max.	Unit
I <sub>S</sub>	Continuous Source Current <sup>1,5</sup>	V <sub>G</sub> =V <sub>D</sub> =0V, Force Current	---	---	78	A
I <sub>SM</sub>	Pulsed Source Current <sup>2,5</sup>		---	---	210	A
V <sub>SD</sub>	Diode Forward Voltage <sup>2</sup>	V <sub>GS</sub> =0V, I <sub>S</sub> =A, T <sub>J</sub> =25°C	---	---	1.2	V
t <sub>rr</sub>	Reverse Recovery Time	I <sub>F</sub> =15A, di/dt=100A/μs, T <sub>J</sub> =25°C	---	23	---	nS
Q <sub>rr</sub>	Reverse Recovery Charge		---	60	---	nC

Note :

- 1.The data tested by surface mounted on a 1 inch<sup>2</sup> FR-4 board with 20Z copper.
- 2.The data tested by pulsed , pulse width ≤ 300us , duty cycle ≤ 2%
- 3.The EAS data shows Max. rating . The test condition is V<sub>DD</sub>=25V, V<sub>GS</sub>=10V, L=0.1mH, I<sub>AS</sub>=43A
- 4.The power dissipation is limited by 150°C junction temperature
- 5.The data is theoretically the same as I<sub>D</sub> and I<sub>DM</sub> , in real applications , should be limited by total power dissipation.



**N-Ch 60V Fast Switching MOSFETs**

**Typical Characteristics**

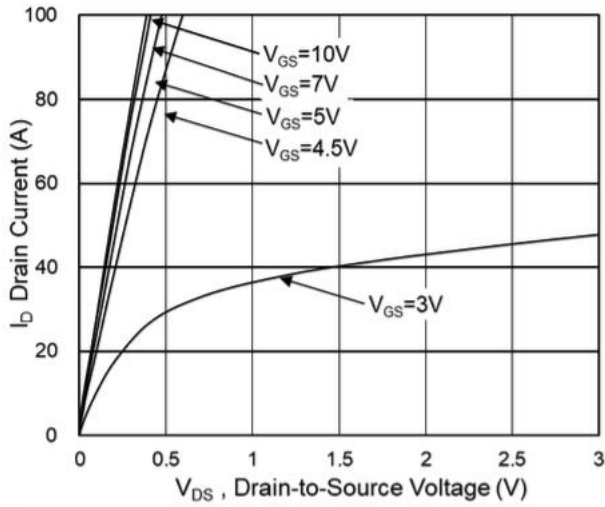

**Fig.1 Typical Output Characteristics**

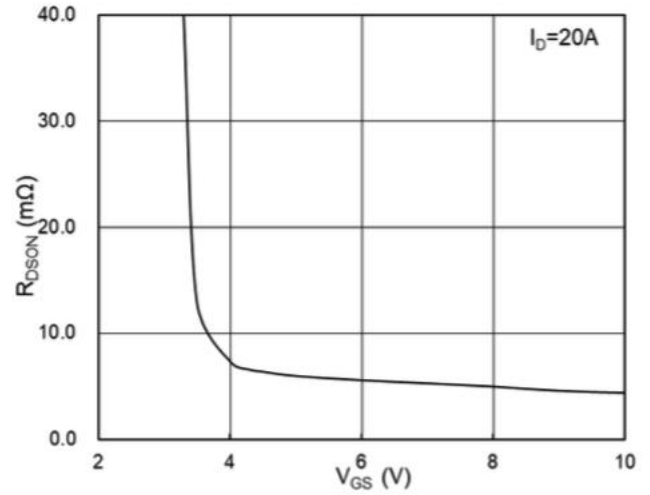

**Fig.2 On-Resistance vs. Gate-Source**

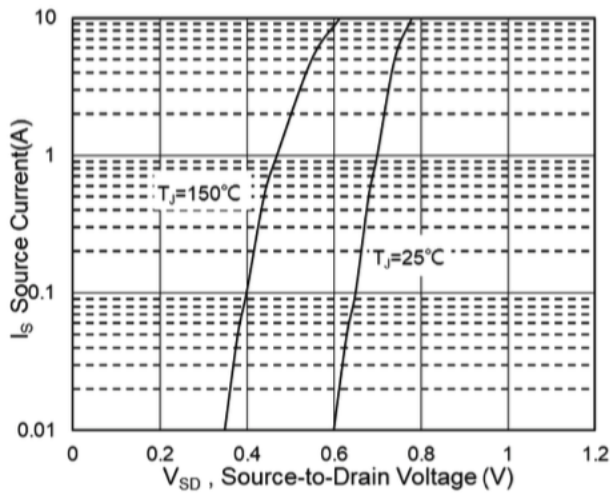

**Fig.3 Source Drain Forward Characteristics**

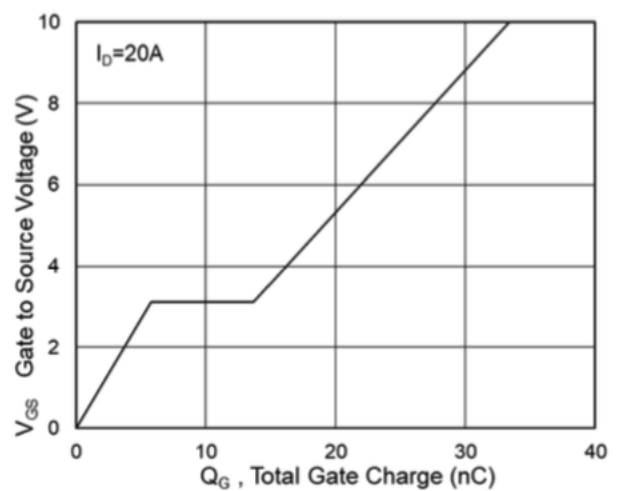

**Fig.4 Gate-Charge Characteristics**

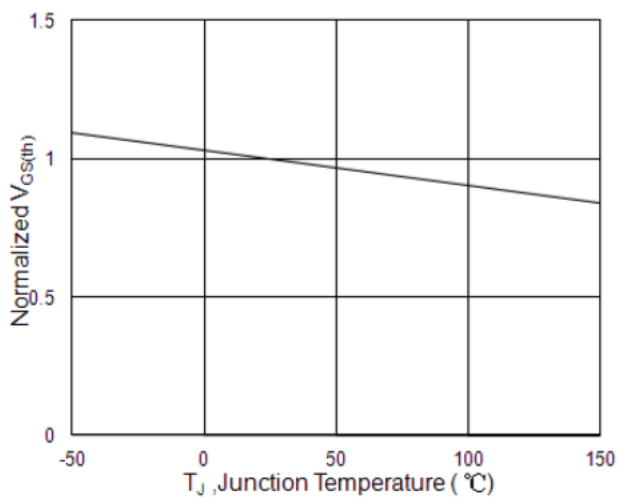

**Fig.5 Normalized  $V_{GS(th)}$  vs.  $T_J$**

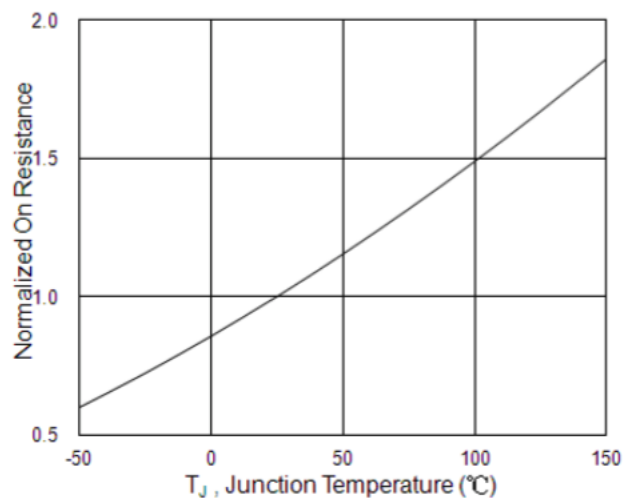

**Fig.6 Normalized  $R_{DS(on)}$  vs.  $T_J$**



**N-Ch 60V Fast Switching MOSFETs**

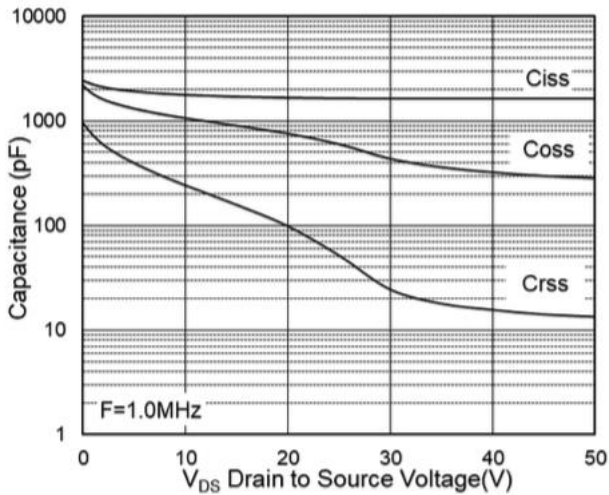

**Fig.7 Capacitance**

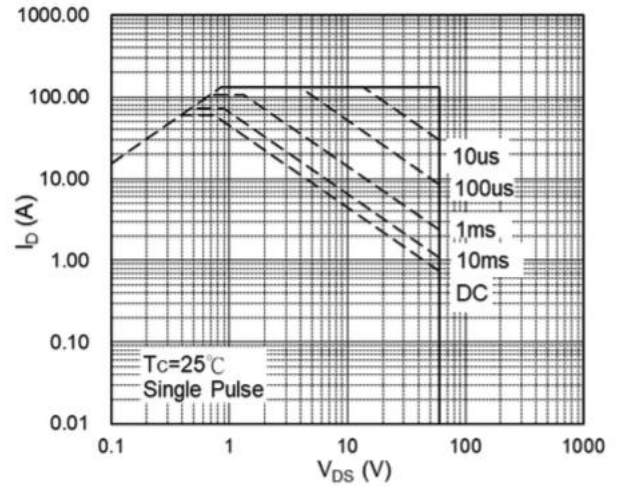

**Fig.8 Safe Operating Area**

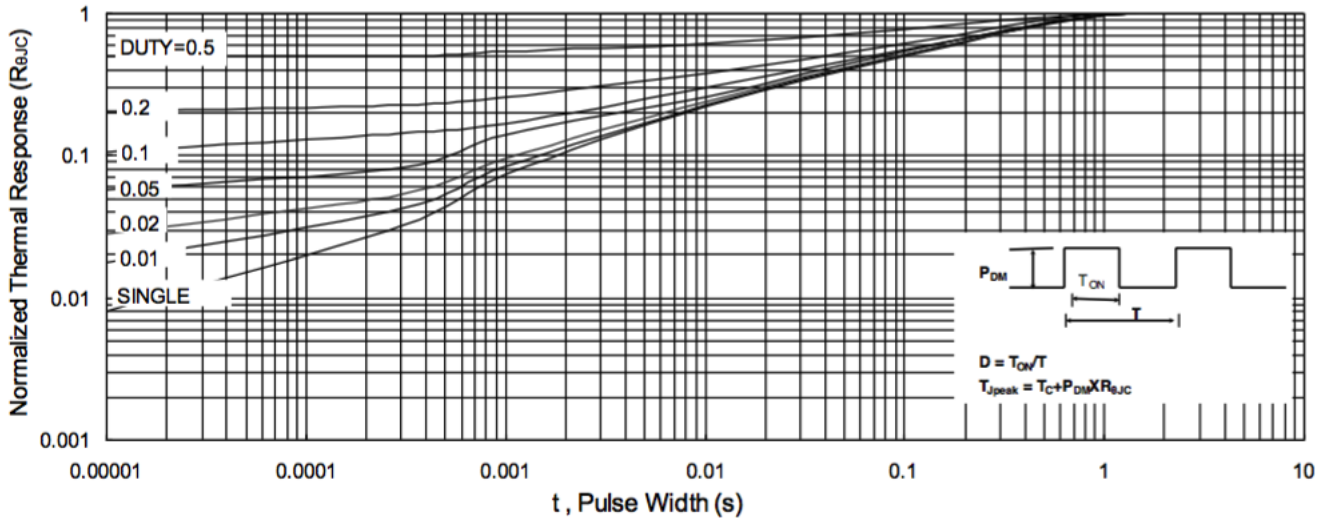

**Fig.9 Normalized Maximum Transient Thermal Impedance**

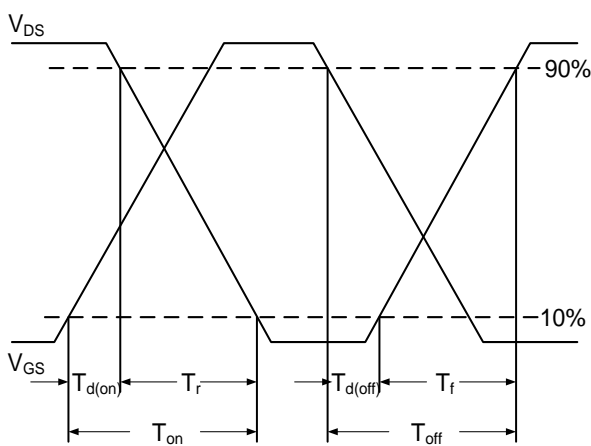

**Fig.10 Switching Time Waveform**

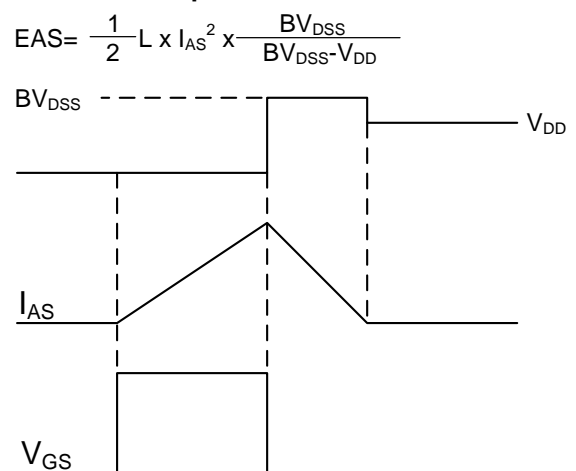
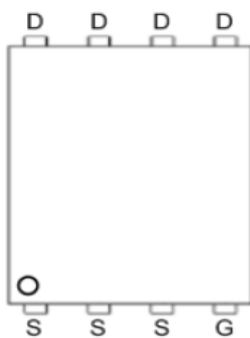
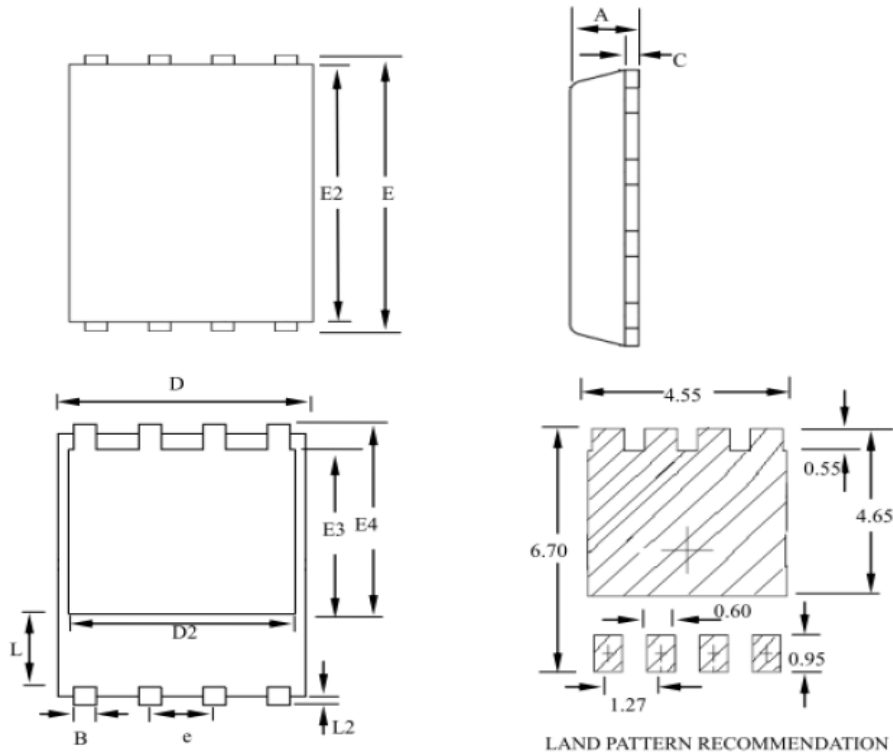

**Fig.11 Unclamped Inductive Switching Waveform**

$$EAS = \frac{1}{2} L \times I_{AS}^2 \times \frac{BV_{DSS}}{BV_{DSS} - V_{DD}}$$

## Ordering Information

Part Number	Package code	Packaging
HSBA6066	PRPAK5*6	3000/Tape&Reel



SYMBOLS	MILLIMETERS			INCHES		
	MIN	NOM	MAX	MIN	NOM	MAX
A	0.80	--	1.20	0.031	--	0.047
B	0.30	--	0.51	0.012	--	0.020
C	0.15	--	0.35	0.006	--	0.014
D	4.80	--	5.30	0.189	--	0.209
D2	3.61	--	4.35	0.142	--	0.171
E	5.90	--	6.35	0.232	--	0.250
E2	5.42	--	5.90	0.213	--	0.232
E3	3.23	--	3.90	0.127	--	0.154
E4	3.69	--	4.55	0.145	--	0.179
L	0.61	--	1.80	0.024	--	0.071
L2	0.05	--	0.36	0.002	--	0.014
e	--	1.27	--	--	0.050	--