

MSKSEMI

SEMICONDUCTOR

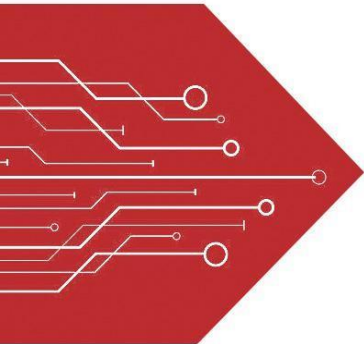

ESD



TVS



TSS



MOV



GDT



PLED

Product data sheet

- Solid-state silicon-avalanche technology
- Low operating and clamping voltage
- Up to four I/O Lines of Protection
- Ultra low capacitance: 0.5pF typical(I/O to I/O)
- Low Leakage
- Low operating voltage:3.3V
- Flow-Through design

IEC COMPATIBILITY (EN61000-4)

- IEC 61000-4-2 (ESD) ±15kV (air), ±8kV (contact)
- IEC 61000-4-4 (EFT) 40A (5/50ns)
- IEC 61000-4-5 (Lightning) 5A (8/20µs)

Mechanical Characteristics

- Molding compound flammability rating: UL 94V-0
- Marking: Marking Code
- Packaging: Tape and Reel
- RoHS/WEEE Compliant

Applications

- Digital Visual Interface(DVI)
- MDDI Ports
- DisplayPort™ Interface
- PCI Express
- High Definition Multi-Media Interface(HDMI)
- eSATA Interfaces

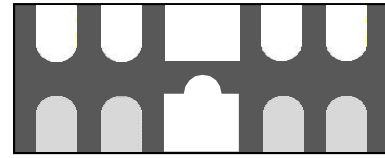

DFN10

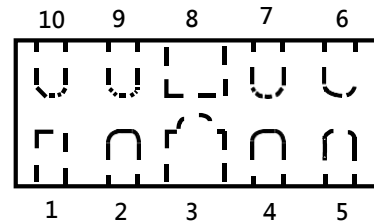

Schematic & PIN Configuration

Pin	Identificaion
1,2,4,5	Input Lines
6,7,9,10	Output Lines (No Internal Connection)
3,8	Ground

Circuit Diagram

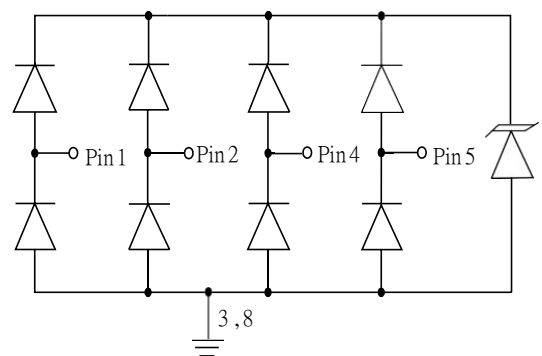

4-Line Protection

Rating	Symbol	Value	Units
Peak Pulse Power ($t_p=8/20\mu s$)	P_{PP}	150	Watts
Peak Pulse Current ($t_p=8/20\mu s$)	I_{pp}	5	A
ESD per IEC 61000-4-2(Air) ESD per IEC 61000-4-2(contact)	V_{ESD}	+/-17 +/-12	kV
Operating Temperature	T_J	-55 to + 125	°C
Storage Temperature	T_{STG}	-55 to +150	°C

Electrical Parameters (T=25°C)

Symbol	Parameter
I_{PP}	Maximum Reverse Peak Pulse Current
V_C	Clamping Voltage @ I_{PP}
V_{RWM}	Working Peak Reverse Voltage
I_R	Maximum Reverse Leakage Current @ V_{RWM}
V_{BR}	Breakdown Voltage @ I_T
I_T	Test Current
I_F	Forward Current
V_F	Forward Voltage @ I_F

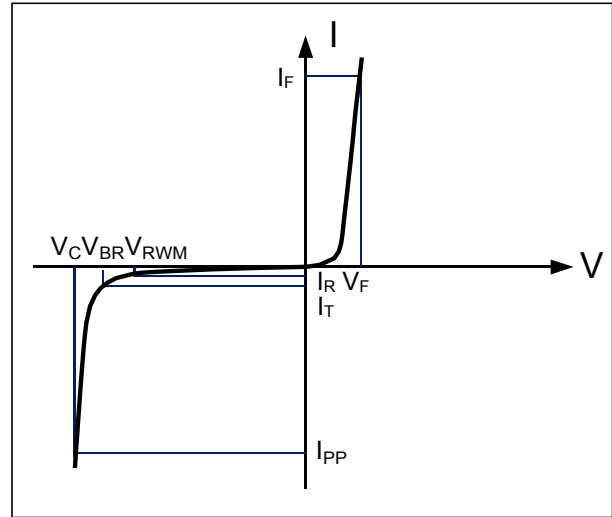

Electrical Characteristics

Parameter	Symbol	Conditions	Minimum	Typical	Maximum	Units
Reverse Stand-Off Voltage	V_{RWM}	Any I/O pin to ground			3.3	V
Reverse Breakdown Voltage	V_{BR}	$I_T = 1mA$ Any I/O pin to ground	6.0			V
Reverse Leakage Current	I_R	$V_{RWM} = 5V, T=25^\circ C$ Any I/O pin to ground			1	μA
Clamping Voltage	V_C	$I_{pp}=5A, t_p=8/20\mu s$ Any I/O pin to ground			15	V
Junction Capacitance	C_j	$V_R = 0V, f = 1MHz$ I/O pin to GND			0.8	pF
		$V_R = 0V, f = 1MHz$ Between I/O pins		0.3		pF

Typical Characteristics

Non-Repetitive Peak Pulse Power vs. Pulse Time

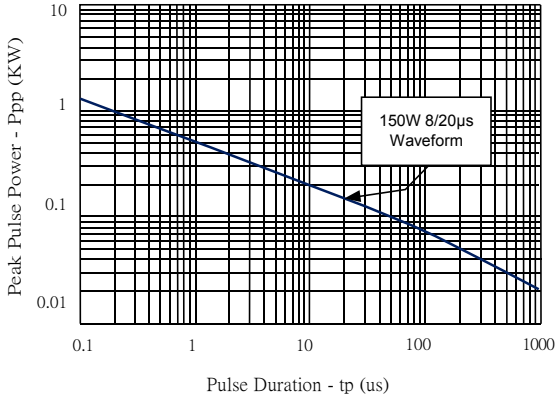

Power Derating curve

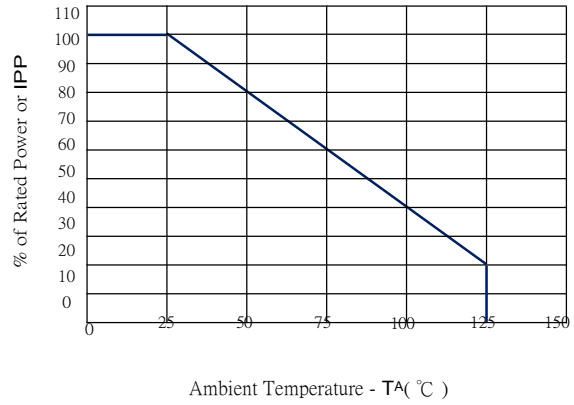

Pulse Waveform

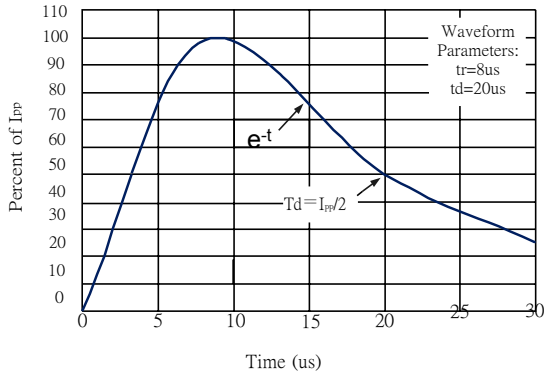

Clamping Voltage vs. Peak Pulse Current

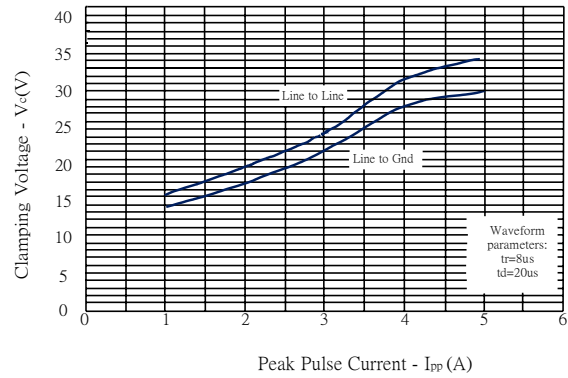

Normalized Capacitance vs. Reverse Voltage

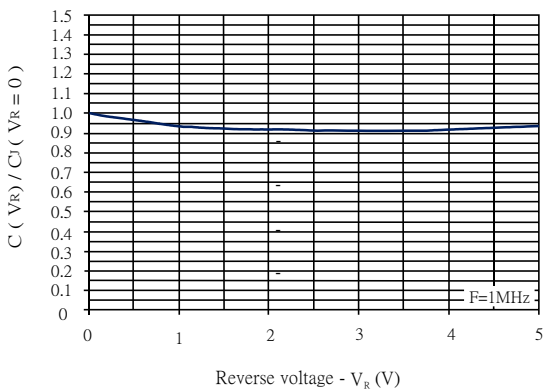

Insertion Loss S21 - I/O to GND

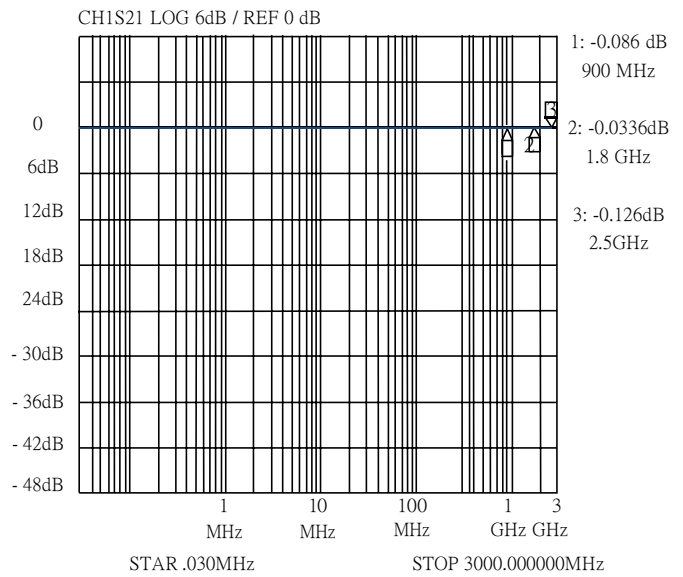

PACKAGE MECHANICAL DATA

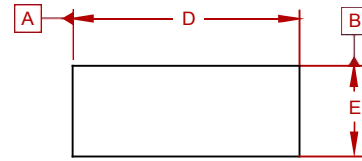
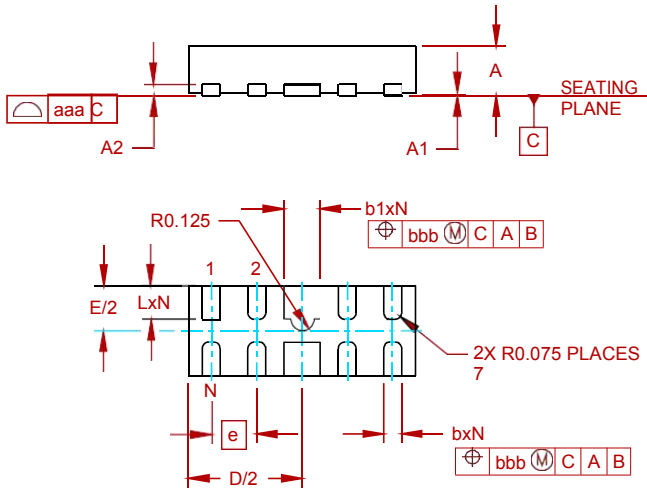

DIM	DIMENSI ONS					
	INCHES			MILLIMETERS		
	MIN	NOM	MAX	MIN	NOM	MAX
A	.020	.023	.026	0.50	0.58	0.65
A1	0.00	.001	.002	0.00	0.03	0.05
A2	(.005)			(0.13)		
b	.006	.008	.010	0.15	0.20	0.25
b1	.014	.016	.018	0.35	0.40	0.45
D	.094	.098	.102	2.40	2.50	2.60
E	.035	.039	.043	0.90	1.00	1.10
e	.020 BSC			0.50 BSC		
L	.012	.015	.017	0.30	0.38	0.425
N	8			8		
aaa	.003			0.08		
bbb	.004			0.10		

Dimensions in millimeters

Suggested Pad Layout

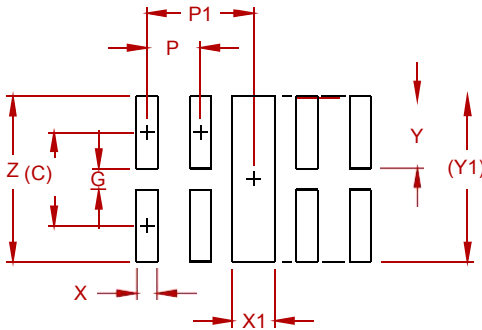

DIM	DIMENSIONS	
	INCHES	MILLIMETERS
C	(.034)	(0.875)
G	.008	0.20
P	.020	0.50
P1	.039	1.00
X	.008	0.20
X1	.016	0.40
Y	.027	0.675
Y1	(.061)	(1.55)
Z	.061	1.55

NOTES:

CONTROLLING DIMENSIONS ARE IN MILLIMETERS (ANGLES IN DEGREES).
THIS LAND PATTERN IS FOR REFERENCE PURPOSES ONLY.
CONSULT YOUR MANUFACTURING GROUP TO ENSURE YOUR COMPANY'S MANUFACTURING GUIDELINES ARE MET.

REEL SPECIFICATION

P/N	PKG	QTY
ESD3V3U4ULC-MS	TSLP-9-1	3000

Attention

- Any and all MSKSEMI Semiconductor products described or contained herein do not have specifications that can handle applications that require extremely high levels of reliability, such as life-support systems, aircraft's control systems, or other applications whose failure can be reasonably expected to result in serious physical and/or material damage. Consult with your MSKSEMI Semiconductor representative nearest you before using any MSKSEMI Semiconductor products described or contained herein in such applications.
- MSKSEMI Semiconductor assumes no responsibility for equipment failures that result from using products at values that exceed, even momentarily, rated values (such as maximum ratings, operating condition ranges, or other parameters) listed in products specifications of any and all MSKSEMI Semiconductor products described or contained herein.
- Specifications of any and all MSKSEMI Semiconductor products described or contained herein stipulate the performance, characteristics, and functions of the described products in the independent state, and are not guarantees of the performance, characteristics, and functions of the described products as mounted in the customer's products or equipment. To verify symptoms and states that cannot be evaluated in an independent device, the customer should always evaluate and test devices mounted in the customer's products or equipment.
- MSKSEMI Semiconductor strives to supply high-quality high-reliability products. However, any and all semiconductor products fail with some probability. It is possible that these probabilistic failures could give rise to accidents or events that could endanger human lives, that could give rise to smoke or fire, or that could cause damage to other property. When designing equipment, adopt safety measures so that these kinds of accidents or events cannot occur. Such measures include but are not limited to protective circuits and error prevention circuits for safe design, redundant design, and structural design.
- In the event that any or all MSKSEMI Semiconductor products (including technical data, services) described or contained herein are controlled under any of applicable local export control laws and regulations, such products must not be exported without obtaining the export license from the authorities concerned in accordance with the above law.
- No part of this publication may be reproduced or transmitted in any form or by any means, electronic or mechanical, including photocopying and recording, or any information storage or retrieval system, or otherwise, without the prior written permission of MSKSEMI Semiconductor.
- Information (including circuit diagrams and circuit parameters) herein is for example only ; it is not guaranteed for volume production. MSKSEMI Semiconductor believes information herein is accurate and reliable, but no guarantees are made or implied regarding its use or any infringements of intellectual property rights or other rights of third parties.
- Any and all information described or contained herein are subject to change without notice due to product/technology improvement, etc. When designing equipment, refer to the "Delivery Specification" for the MSKSEMI Semiconductor product that you intend to use.