

## Product profile

### General description

PESD1LIN in a very small SOD323 (SC-76) Surface-Mounted Device (SMD) plastic package designed to protect one automotive Local Interconnect Network (LIN) bus line from the damage caused by ElectroStatic Discharge (ESD) and other transients.

### Features and benefits

- ESD protection of one automotive LIN-bus line
- Asymmetrical diode configuration ensures an optimized protection against ElectroMagnetic Interferences (EMI) of a LIN Electronic Control Unit (ECU)
- Max. peak pulse power:  $P_{PP} = 160 \text{ W}$  at  $t_p = 8/20 \mu\text{s}$
- Low clamping voltage:  $V_{CL} = 40 \text{ V}$  at  $I_{PP} = 1 \text{ A}$
- Ultra low leakage current:  $I_{RM} < 1 \text{ nA}$
- ESD protection of up to 23 kV
- IEC 61000-4-2, level 4 (ESD)
- IEC 61000-4-5 (surge);  $I_{PP} = 3 \text{ A}$  at  $t_p = 8/20 \mu\text{s}$
- AEC-Q101 qualified

### Applications

- LIN-bus protection
- Automotive applications

### Quick reference data

**Table 1. Quick reference data**  
*T<sub>amb</sub> = 25 °C unless otherwise specified.*

| Symbol           | Parameter                | Conditions                         | Min | Typ | Max | Unit |
|------------------|--------------------------|------------------------------------|-----|-----|-----|------|
| V <sub>RWM</sub> | reverse standoff voltage |                                    |     |     |     |      |
|                  | PESD1LIN (15 V)          |                                    | -   | -   | 15  | V    |
|                  | PESD1LIN (24 V)          |                                    | -   | -   | 24  | V    |
| C <sub>d</sub>   | diode capacitance        | V <sub>R</sub> = 0 V;<br>f = 1 MHz | -   | 13  | 17  | pF   |

## Pinning information

**Table 2. Pinning**

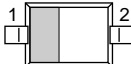
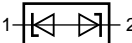
| Pin | Description      | Simplified outline   | Graphic symbol  |
|-----|------------------|--|---|
| 1   | cathode 1 (15 V) |  |  |
| 2   | cathode 2 (24 V) |  |   |

## Limiting values

**Table 3. Limiting values**

*In accordance with the Absolute Maximum Rating System (IEC 60134).*

| Symbol    | Parameter            | Conditions         | Min   | Max  | Unit |
|-----------|----------------------|--------------------|-------|------|------|
| $P_{PP}$  | peak pulse power     | $t_p = 8/20 \mu s$ | [1] - | 160  | W    |
| $I_{PP}$  | peak pulse current   | $t_p = 8/20 \mu s$ | [1] - | 3    | A    |
| $T_j$     | junction temperature |                    | -     | 150  | °C   |
| $T_{amb}$ | ambient temperature  |                    | -65   | +150 | °C   |
| $T_{stg}$ | storage temperature  |                    | -65   | +150 | °C   |

[1] Non-repetitive current pulse 8/20  $\mu s$  exponential decay waveform according to IEC 61000-4-5.

**Table 4. ESD maximum ratings**

| Symbol    | Parameter                       | Conditions                        | Min   | Max | Unit |
|-----------|---------------------------------|-----------------------------------|-------|-----|------|
| $V_{ESD}$ | electrostatic discharge voltage | IEC 61000-4-2 (contact discharge) | [1] - | 23  | kV   |
|           |                                 | MIL-STD-883 (human body model)    | -     | 10  | kV   |

[1] Device stressed with ten non-repetitive ESD pulses.

**Table 5. ESD standards compliance**

| Standard                                | Conditions                      |
|---|---------------------------------|
| IEC 61000-4-2; level 4 (ESD)            | > 15 kV (air); > 8 kV (contact) |
| MIL-STD-883; class 3 (human body model) | > 4 kV                          |

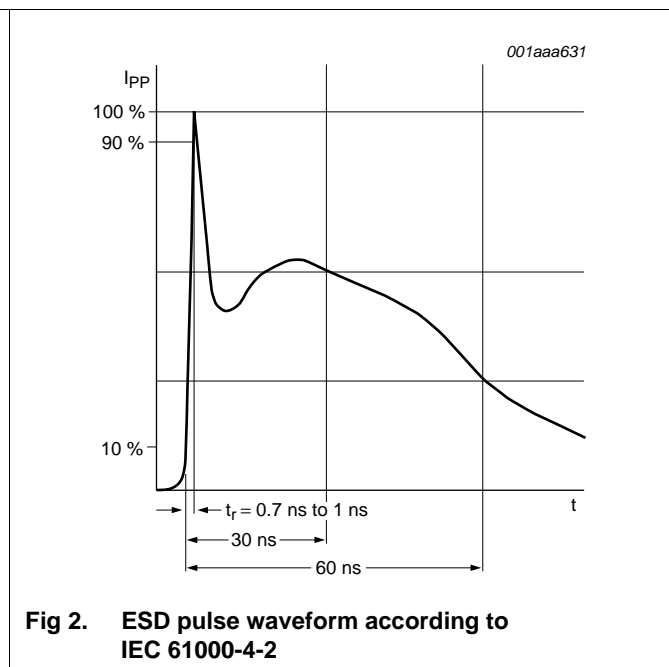
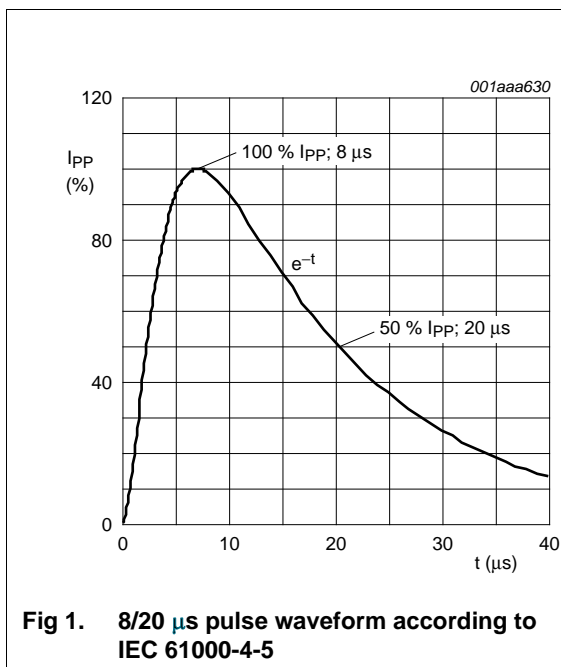

## Characteristics

**Table 6. Characteristics**

$T_{amb} = 25\text{ }^{\circ}\text{C}$  unless otherwise specified.

| Symbol    | Parameter                | Conditions                           | Min  | Typ  | Max  | Unit     |
|-----------|--------------------------|--------------------------------------|------|------|------|----------|
| $V_{RWM}$ | reverse standoff voltage |                                      |      |      |      |          |
|           | PESD1LIN (15 V)          |                                      | -    | -    | 15   | V        |
|           | PESD1LIN (24 V)          |                                      | -    | -    | 24   | V        |
| $I_{RM}$  | reverse leakage current  |                                      |      |      |      |          |
|           | PESD1LIN (15 V)          | $V_{RWM} = 15\text{ V}$              | -    | < 1  | 50   | nA       |
|           | PESD1LIN (24 V)          | $V_{RWM} = 24\text{ V}$              | -    | < 1  | 50   | nA       |
| $V_{BR}$  | breakdown voltage        | $I_R = 5\text{ mA}$                  |      |      |      |          |
|           | PESD1LIN (15 V)          |                                      | 17.1 | 18.9 | 20.3 | V        |
|           | PESD1LIN (24 V)          |                                      | 25.4 | 27.8 | 30.3 | V        |
| $C_d$     | diode capacitance        | $V_R = 0\text{ V}; f = 1\text{ MHz}$ | -    | 13   | 17   | pF       |
| $V_{CL}$  | clamping voltage         |                                      | [1]  |      |      |          |
|           | PESD1LIN (15 V)          | $I_{PP} = 1\text{ A}$                | -    | -    | 25   | V        |
|           |                          | $I_{PP} = 5\text{ A}$                | -    | -    | 44   | V        |
|           | PESD1LIN (24 V)          | $I_{PP} = 1\text{ A}$                | -    | -    | 40   | V        |
|           |                          | $I_{PP} = 3\text{ A}$                | -    | -    | 70   | V        |
| $r_{dif}$ | differential resistance  |                                      |      |      |      |          |
|           | PESD1LIN (15 V)          | $I_R = 1\text{ mA}$                  | -    | -    | 225  | $\Omega$ |
|           | PESD1LIN (24 V)          | $I_R = 1\text{ mA}$                  | -    | -    | 300  | $\Omega$ |

[1] Non-repetitive current pulse 8/20  $\mu\text{s}$  exponential decay waveform according to IEC 61000-4-5.

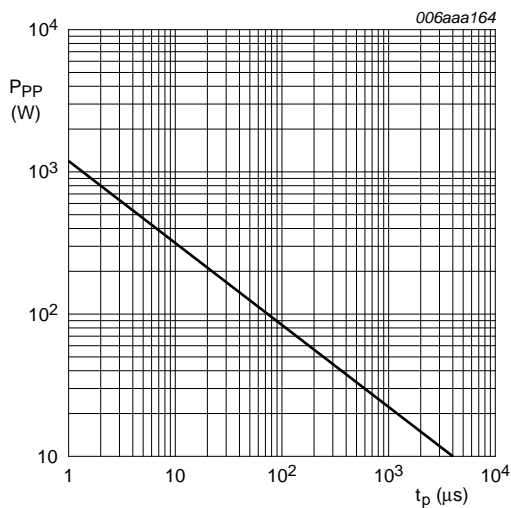

$T_{amb} = 25\text{ }^{\circ}\text{C}$

**Fig 3. Peak pulse power as a function of exponential pulse duration; typical values**

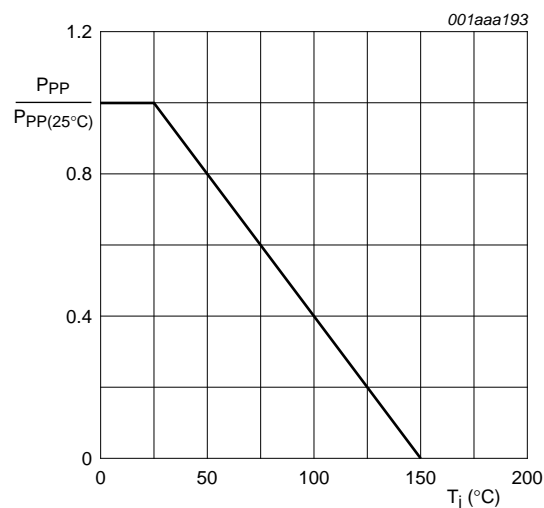

**Fig 4. Relative variation of peak pulse power as a function of junction temperature; typical values**

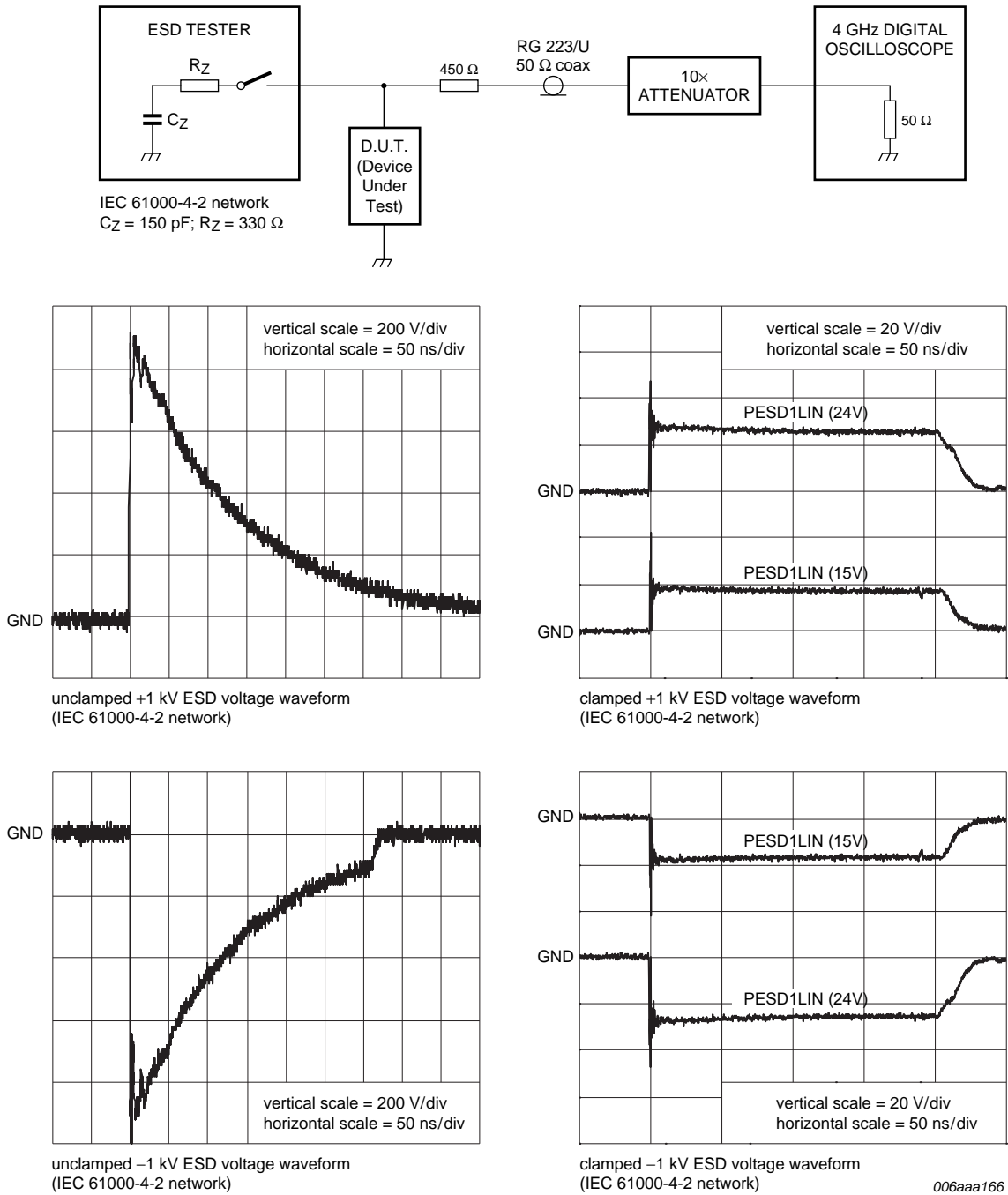
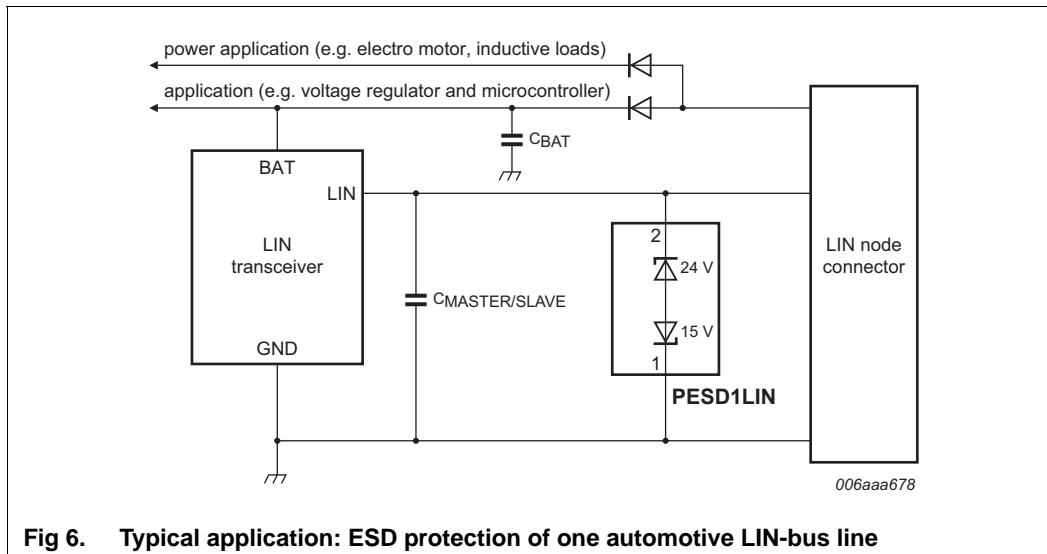

Fig 5. ESD clamping test setup and waveforms

## Application information

The PESD1LIN is designed for the protection of one LIN-bus signal line from the damage caused by ESD and surge pulses. The PESD1LIN provides a surge capability of up to 160 W per line for a 8/20  $\mu$ s waveform.



**Fig 6. Typical application: ESD protection of one automotive LIN-bus line**

### Circuit board layout and protection device placement

Circuit board layout is critical for the suppression of ESD, Electrical Fast Transient (EFT) and surge transients. The following guidelines are recommended:

1. Place the PESD1LIN as close to the input terminal or connector as possible.
2. The path length between the PESD1LIN and the protected line should be minimized.
3. Keep parallel signal paths to a minimum.
4. Avoid running protection conductors in parallel with unprotected conductor.
5. Minimize all Printed-Circuit Board (PCB) conductive loops including power and ground loops.
6. Minimize the length of the transient return path to ground.
7. Avoid using shared transient return paths to a common ground point.
8. Ground planes should be used whenever possible. For multilayer PCBs, use ground vias.

## Test information

### Quality information

This product has been qualified in accordance with the Automotive Electronics Council (AEC) standard Q101 - *Stress test qualification for discrete semiconductors*, and is suitable for use in automotive applications.

Package outline

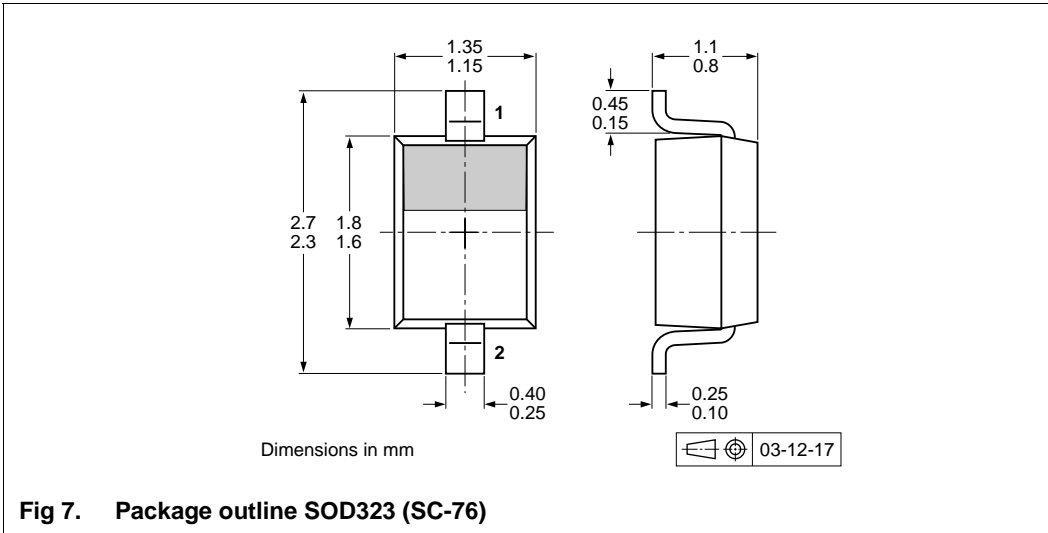

Fig 7. Package outline SOD323 (SC-76)

Soldering

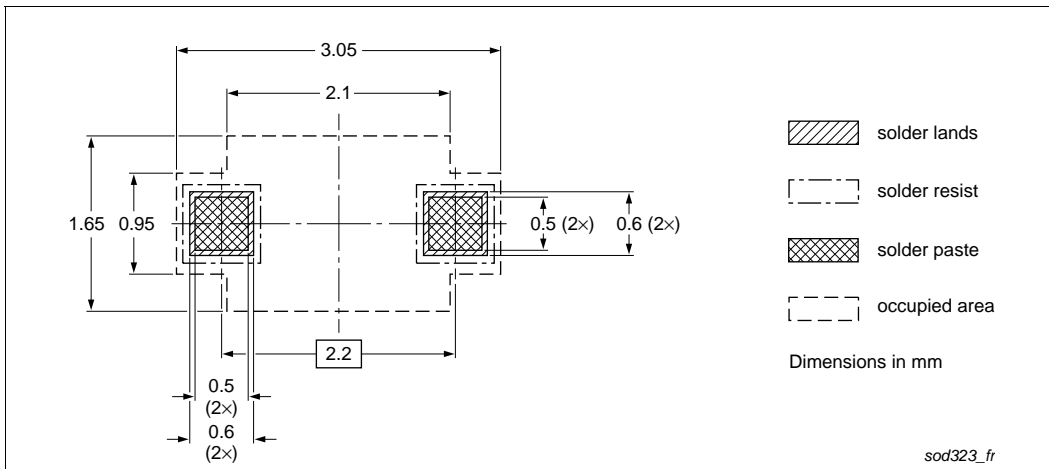

Fig 8. Reflow soldering footprint SOD323 (SC-76)

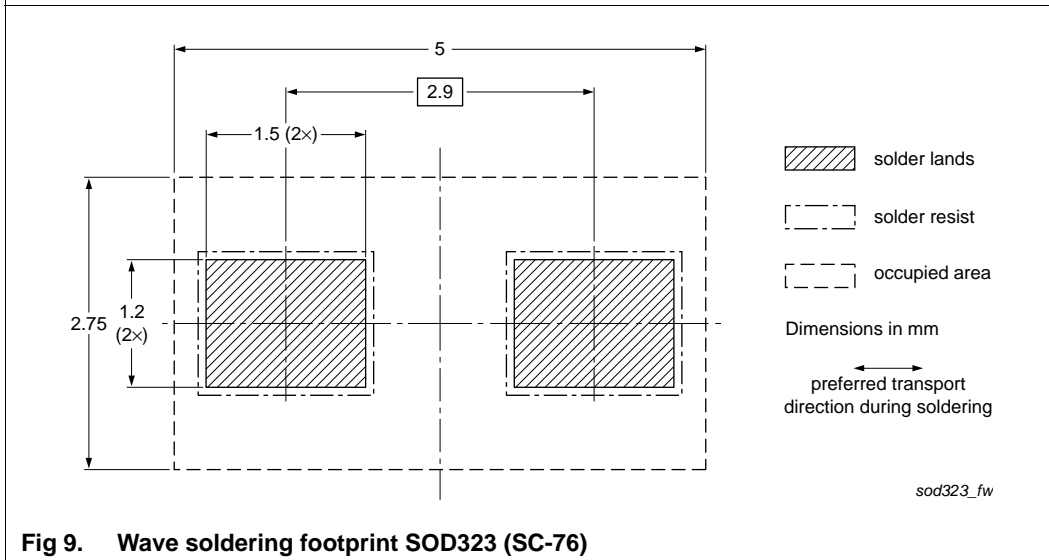

Fig 9. Wave soldering footprint SOD323 (SC-76)

## Marking



## Ordering information

| Order code   | Package | Base qty | Delivery mode |
|--------------|---------|----------|---------------|
| UMW PESD1LIN | SOD-323 | 3000     | Tape and reel |