

REV	LOCATIONS	DESCRIPTION	DATE	REVISER	APPD
1	△	Tolerances change	09/APR/20	KATE	CHERRY

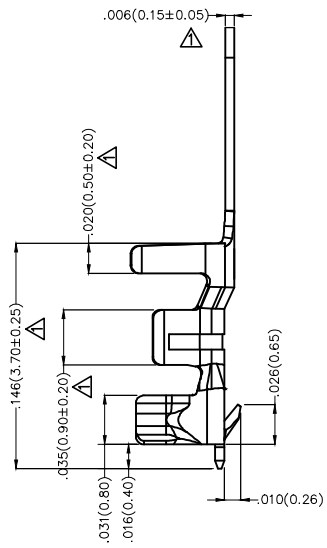

Notes:

- 1.Material:Phosphor Bronze C5191
- 2.Plating:Gold-Plated
- 3.Wire Range: 26AWG~30AWG
- 4.Insulation Nom.Dia: ϕ .026''(ϕ 0.65mm)~ ϕ .035''(ϕ 0.9mm)
- 5.Applicable Housing:FHG12505 Series
- 6.Minimum Order Quantity :15,000 PCS

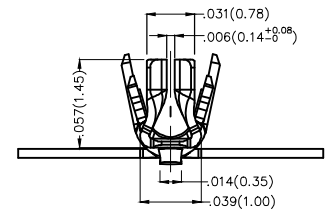
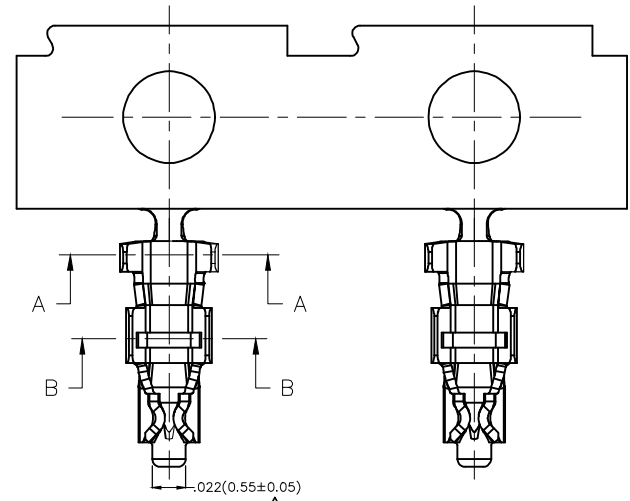
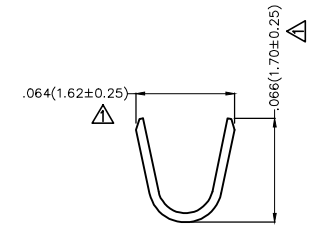

Section A-A

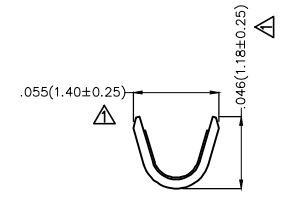

Section B-B

 THIRD ANGLE PROJECTION	GENERAL TOLERANCES (UNLESS SPECIFIED)		APPROVE BY	DATE	PART NO.	ITEM NO.	 Leader Of Industry	
	X.±.012(0.30)	X.'±5'	FRANK	25/JUN/13	FT12504-F1H	FT12504		
	DESIGN UNITS Inch (metric)	X.X±.008(0.20)	X.'±2'	CHECKED BY	DATE	TITLE		REV 1 SHEET NO. 1/2
	SCALE	X.XX±.006(0.15)	X.'±1'	JACOB	25/JUN/13	Wire to Board Pitch 1.25mm(Terminal)		
SIZE	X.XXX±.004(0.10)	X.'±0.5'	DRAWN BY	DATE	THIS DRAWING CONTAINS INFORMATION THAT IS PROPRIETARY TO TXGA INDUSTRIAL ELECTRONICS(S.Z)CO.,LTD AND SHOULD NOT BE USED WITHOUT WRITTEN PERMISSION			
5:1	A4		CHERRY	25/JUN/13				

REV	LOCATIONS	DESCRIPTION	DATE	REVISER	APPD

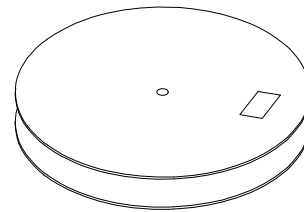
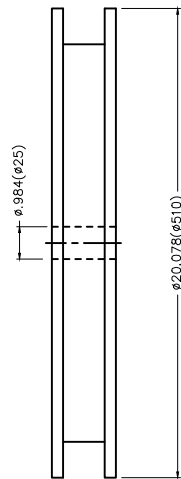
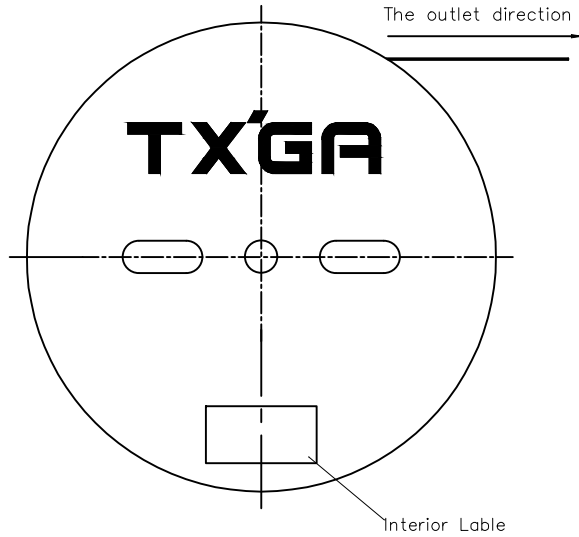

15,000 Pcs/Reel

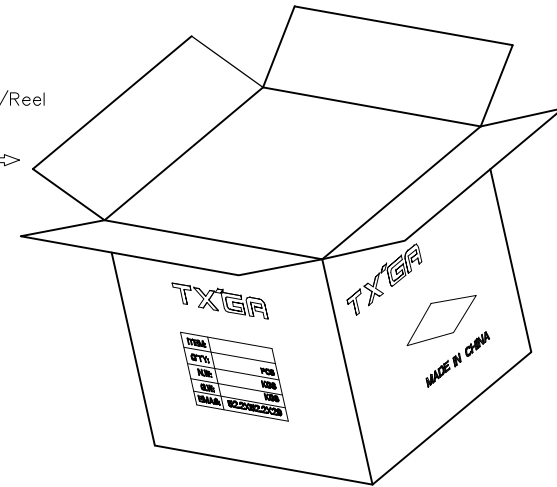

<p>THIRD ANGLE PROJECTION</p>	GENERAL TOLERANCES (UNLESS SPECIFIED)		APPROVE BY	DATE	PART NO.	ITEM NO.	<p>Leader Of Industry</p>	
	X.±.012(0.30)	X.'±5'	FRANK	25/JUN/13	FT12504-F1H	FT12504		
	DESIGN UNITS Inch (metric)	X.X±.008(0.20)	.X'±2'	CHECKED BY	DATE	TITLE		REV 1 SHEET NO. 2/2
	SCALE	X.XX±.006(0.15)	.XX'±1'	JACOB	25/JUN/13	Wire to Board Pitch 1.25mm(Terminal)		
5:1	X.XXX±.004(0.10)	.XXX'±0.5'	DRAWN BY	DATE	THIS DRAWING CONTAINS INFORMATION THAT IS PROPRIETARY TO TXGA INDUSTRIAL ELECTRONICS(S.Z)CO.,LTD AND SHOULD NOT BE USED WITHOUT WRITTEN PERMISSION			
SIZE			CHERRY	25/JUN/13				
A4								