

REV	LOCATIONS	DESCRIPTION	DATE	REVISER	APPD
1	△	Add dimensions	23/SEP/16	KATE	FRANK

Notes:

1. Material: Phosphor Bronze C5191
2. Plating: Tin-Plated
3. Wire Range: 14AWG~24AWG
4. Insulation Nom. Dia: ϕ 1.38" (ϕ 3.5mm Max)
5. Applicable Housing: FHG63504, FHG63505, FHG63506 Series
6. Minimum Order Quantity 4,500 PCS

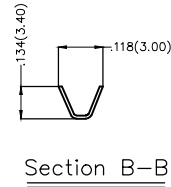
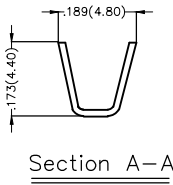
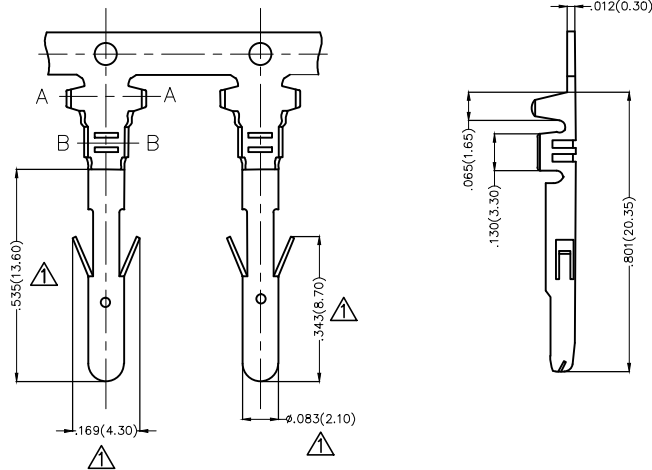

 THIRD ANGLE PROJECTION	GENERAL TOLERANCES (UNLESS SPECIFIED)		APPROVE BY FRANK	DATE 25/JUN/13	PART NO. FT63501-M2H	ITEM NO. FT63501	 Leader Of Industry	
	DESIGN UNITS Inch (metric)	X.X±.012(0.30)	X'.±5'	CHECKED BY JACOB	DATE 25/JUN/13	TITLE Wire to Board Pitch 6.35mm(Terminal)		REV 1
SCALE 5:1	SIZE A4	X.XX±.006(0.15)	.XX'±1'	DRAWN BY CHERRY	DATE 25/JUN/13	THIS DRAWING CONTAINS INFORMATION THAT IS PROPRIETARY TO TXGA INDUSTRIAL ELECTRONICS(S.Z)CO.,LTD AND SHOULD NOT BE USED WITHOUT WRITTEN PERMISSION		
		X.XXX±.004(0.10)	.XXX'±0.5'					

REV	LOCATIONS	DESCRIPTION	DATE	REVISER	APPD

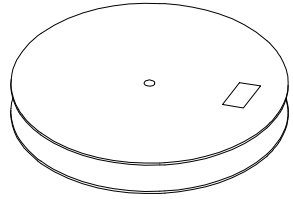
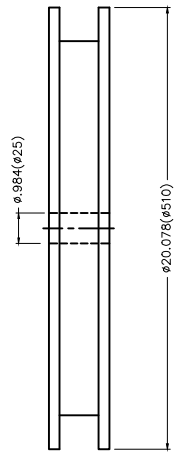
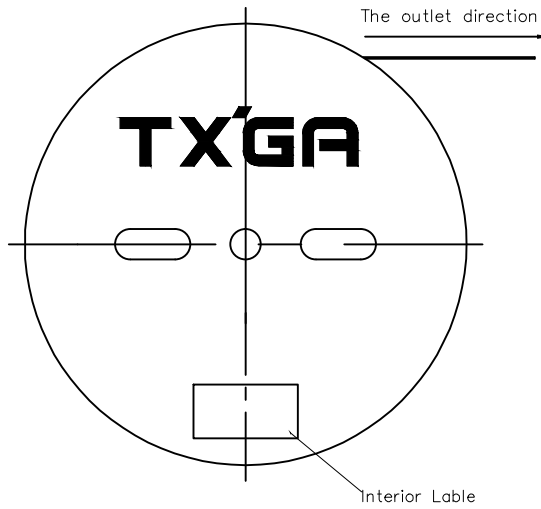

4,500Pcs/Reel

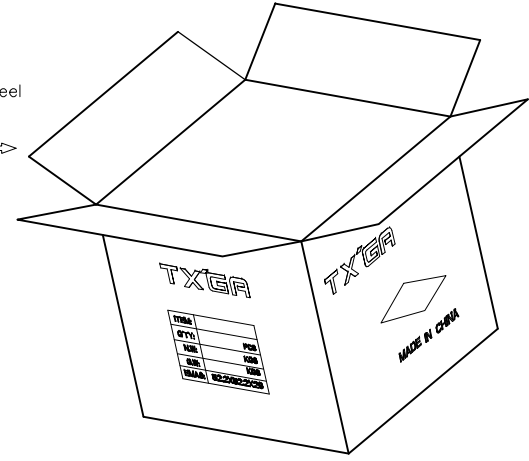

 THIRD ANGLE PROJECTION	GENERAL TOLERANCES (UNLESS SPECIFIED)		APPROVE BY	DATE	PART NO.	ITEM NO.	 Leader Of Industry
	X.±.012(0.30)	X.±5'	FRANK	25/JUN/13	FT63501-M2H	FT63501	
DESIGN UNITS Inch (metric)	X.XX±.008(0.20)	.X'±2'	CHECKED BY	DATE	TITLE		REV 1
SCALE	X.XX±.006(0.15)	.XX'±1'	JACOB	25/JUN/13	Wire to Board Pitch 6.35mm(Terminal)		SHEET NO. 2/2
5:1	X.XXX±.004(0.10)	.XXX'±0.5'	DRAWN BY	DATE	THIS DRAWING CONTAINS INFORMATION THAT IS PROPRIETARY TO TXGA INDUSTRIAL ELECTRONICS(S.Z)CO.,LTD AND SHOULD NOT BE USED WITHOUT WRITTEN PERMISSION		
A4			CHERRY	25/JUN/13			