



Aluminum electrolytic capacitors

Single-ended capacitors

Series/Type: B41866

Date: December 2019

Long-life grade capacitors

Applications

- Automotive electronics

Features

- High reliability and long useful life
- High ripple current capability
- Wide temperature range up to 125 °C
- RoHS-compatible

Construction

- Charge-discharge proof, polar
- Aluminum case with PET insulating sleeve
- Minus pole marking on the insulating sleeve
- Case with safety vent

Delivery mode

Terminal configurations and packing:

- Bulk
- Taped, Ammo pack
- Cut
- Kinked
- PAPR (Protection Against Polarity Reversal):
crimped leads, J leads, bent leads

Refer to chapter "Single-ended capacitors – Taping, packing and lead configurations" for further details.



Specifications and characteristics in brief

Rated voltage V_R	10 ... 75 V DC						
Surge voltage V_S	$1.15 \cdot V_R$ (1.1 · V_R for 75 V DC)						
Rated capacitance C_R	47 ... 10000 μF						
Capacitance tolerance	$\pm 20\% \triangleq M$						
Dissipation factor $\tan \delta$ (20 °C, 120 Hz)	For capacitance higher than 1000 μF add 0.02 for every increase of 1000 μF .						
	V_R (V DC)	10	16 ... 25	35	50	63	75
	$\tan \delta$ (max.)	0.20	0.17	0.12	0.10	0.12	0.12
Leakage current I_{leak} (20 °C, 5 min)	$I_{\text{leak}} = 0.01 \mu\text{A} \cdot \left(\frac{C_R}{\mu\text{F}} \cdot \frac{V_R}{\text{V}} \right)$ or 3 μA , whichever is greater						
Self-inductance ESL	Diameter (mm)	8 ... 12.5		16		18	
	ESL (nH)	20		26		34	
Useful life ¹⁾ 125 °C; V_R ; $I_{\text{AC,R}}$	$\leq 63 \text{ V}$	75 V		Requirements: $ \Delta C/C \leq 35\%$ of initial value $\tan \delta \leq 3$ times initial specified limit $I_{\text{leak}} \leq$ initial specified limit			
	> 2000 h for $\varnothing = 8 \text{ mm}$ > 3000 h for $\varnothing = 10 \text{ mm}$ > 5000 h for $\varnothing \geq 12.5 \text{ mm}$	> 3000 h					
Voltage endurance test 125 °C; V_R	$\leq 63 \text{ V}$	75 V		Post test requirements: $ \Delta C/C \leq 30\%$ of initial value $\tan \delta \leq 2$ times initial specified limit $I_{\text{leak}} \leq$ initial specified limit			
	2000 h for $\varnothing = 8 \text{ mm}$ 3000 h for $\varnothing = 10 \text{ mm}$ 5000 h for $\varnothing \geq 12.5 \text{ mm}$	3000 h					
Vibration resistance test	To IEC 60068-2-6, test Fc: Frequency range 10 Hz ... 2 kHz, displacement amplitude max. 1.5 mm, acceleration max. 20 g, duration 3 × 2 h. Capacitor rigidly clamped by the aluminum case e.g. using our standard fixture						
IEC climatic category	To IEC 60068-1: 55/125/56 (–55 °C/+125 °C/56 days damp heat test)						
Sectional specification	IEC 60384-4						
Reference standard	AEC-Q200 ²⁾						

1) Refer to chapter "General technical information, 5 Useful life" on how to interpret useful life.

2) Refer to chapter "General technical information, 2.3 AEC-Q200 standard" for further details.



B41866

High ripple current – 125 °C

Dimensional drawings

With stand-off rubber seal

Diameters (mm): 10, 12.5, 16, 18

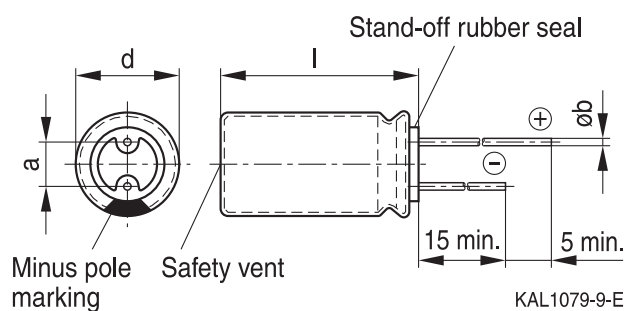

With flat rubber seal

Diameter (mm): 8

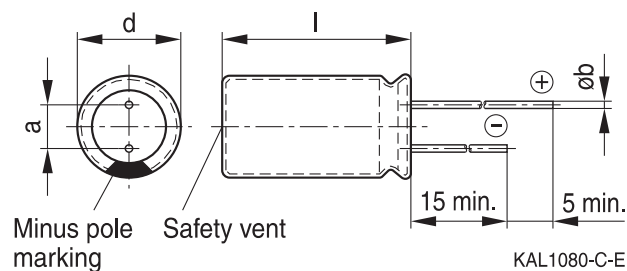

Dimensions and weights

Dimensions (mm)				Approx. weight
d +0.5	l	a ±0.5	b	g
8	11.5 +1.5	3.5	0.60 ±0.05	1.0
10	12.5 +1.0	5.0	0.60 ±0.05	1.6
10	16 +1.0	5.0	0.60 ±0.05	1.9
10	20 +2.0	5.0	0.60 ±0.05	2.6
12.5	20 +2.0	5.0	0.60 ±0.05	3.6
12.5	25 +2.0	5.0	0.60 ±0.05	4.5
16	20 +2.0	7.5	0.80 ±0.05	5.5
16	25 +2.0	7.5	0.80 ±0.05	7.5
16	31.5 +2.0	7.5	0.80 ±0.05	7.8
16	35.5 +2.0	7.5	0.80 ±0.05	9.2
18	20 +2.0	7.5	0.80 ±0.1	8.0
18	25 +2.0	7.5	0.80 ±0.1	9.0
18	31.5 +2.0	7.5	0.80 ±0.1	11.0
18	35 +2.0	7.5	0.80 ±0.1	13.0
18	40 +2.0	7.5	0.80 ±0.1	16.0



Overview of available types

Other voltage and capacitance ratings are available upon request.

V_R (V DC)	10	16	25	35
	Case dimensions $d \times l$ (mm)			
C_R (μ F)				
100			8 × 11.5	8 × 11.5
120			8 × 11.5	8 × 11.5
150			8 × 11.5	10 × 12.5
180			8 × 11.5	10 × 12.5
220			8 × 11.5	10 × 12.5
270			10 × 12.5	10 × 16
330		8 × 11.5	10 × 12.5	10 × 16
390			10 × 16	10 × 20
470	8 × 11.5	10 × 12.5	10 × 16	10 × 20
560	10 × 12.5		10 × 20	12.5 × 20
680	10 × 16		10 × 20	12.5 × 20
820		10 × 16	12.5 × 20	12.5 × 25
1000	10 × 16	10 × 20	12.5 × 20	16 × 20
1200		12.5 × 20	12.5 × 25	16 × 25
1500	10 × 20		12.5 × 25	16 × 25 18 × 20
1800		12.5 × 25	16 × 20	16 × 31.5 18 × 25
2200	12.5 × 20	16 × 20	16 × 25 18 × 20	16 × 35.5 18 × 31.5
2700	12.5 × 25	18 × 20	18 × 25	18 × 35
3300	16 × 20	18 × 25	16 × 31.5	18 × 40
3900			16 × 35.5 18 × 31.5	
4700	18 × 20	18 × 31.5	18 × 35	
5600		18 × 35	18 × 40	
6800		18 × 40		
8200	18 × 31.5			
10000	18 × 40			



B41866

High ripple current – 125 °C

Overview of available types

Other voltage and capacitance ratings are available upon request.

V_R (V DC)	50	63	75
	Case dimensions $d \times l$ (mm)		
C_R (μF)			
47	8 × 11.5		
56	8 × 11.5		
68	8 × 11.5		
82	8 × 11.5		
100	10 × 12.5	10 × 16	
120	10 × 16		
150	10 × 16		
180	10 × 20	10 × 20	
220	10 × 20	12.5 × 20	
270	10 × 20		16 × 20
330	12.5 × 20	12.5 × 20	16 × 25 18 × 25
390	12.5 × 25		
470	12.5 × 25 16 × 20	16 × 20	16 × 31.5 18 × 25
560	16 × 20		
680	16 × 25	16 × 25 18 × 20	18 × 31.5
820	16 × 25 18 × 20	16 × 31.5	18 × 35
1000	16 × 31.5 18 × 25	16 × 31.5	18 × 40
1200	16 × 35.5 18 × 31.5	18 × 31.5	
1500	18 × 35	18 × 35	
1800	18 × 40	18 × 40	

Technical data and ordering codes

C_R	Case dimensions	ESR_{max} 10 kHz	ESR_{max} 10 kHz	Z_{max} 100 kHz	$I_{AC,R}$ 100 kHz	Ordering code (composition see below)
120 Hz	$d \times l$	–40 °C	20 °C	20 °C	125 °C	
20 °C	mm	Ω	Ω	Ω	mA	
μF						

 $V_R = 10 V DC$

470	8 × 11.5	5.170	0.646	0.573	297	B41866C3477M***
560	10 × 12.5	2.980	0.373	0.336	450	B41866C3567M***
680	10 × 16	1.404	0.175	0.160	714	B41866C3687M***
1000	10 × 16	1.404	0.175	0.160	714	B41866C3108M***
1500	10 × 20	1.070	0.134	0.127	875	B41866C3158M***
2200	12.5 × 20	0.881	0.110	0.104	1105	B41866C3228M***
2700	12.5 × 25	0.710	0.089	0.082	1358	B41866C3278M***
3300	16 × 20	0.401	0.050	0.046	1895	B41866C3338M***
4700	18 × 20	0.341	0.043	0.040	2190	B41866D3478M***
8200	18 × 31.5	0.226	0.028	0.027	3178	B41866C3828M***
10000	18 × 40	0.153	0.019	0.018	4244	B41866C3109M***

 $V_R = 16 V DC$

330	8 × 11.5	5.170	0.646	0.573	297	B41866C4337M***
470	10 × 12.5	2.980	0.373	0.336	450	B41866C4477M***
820	10 × 16	1.404	0.175	0.160	714	B41866C4827M***
1000	10 × 20	1.070	0.134	0.127	875	B41866C4108M***
1200	12.5 × 20	0.881	0.110	0.104	1105	B41866C4128M***
1800	12.5 × 25	0.710	0.089	0.082	1358	B41866C4188M***
2200	16 × 20	0.401	0.050	0.046	1895	B41866C4228M***
2700	18 × 20	0.341	0.043	0.040	2190	B41866D4278M***
3300	18 × 25	0.314	0.039	0.037	2454	B41866C4338M***
4700	18 × 31.5	0.226	0.028	0.027	3178	B41866C4478M***
5600	18 × 35	0.187	0.023	0.022	3638	B41866C4568M***
6800	18 × 40	0.153	0.019	0.018	4244	B41866C4688M***

Composition of ordering code

*** = Version

- 000 = for standard leads, bulk
- 001 = for kinked leads, bulk (for $d \times l = 10 \times 20$ mm and $\varnothing 12.5 \dots 18$ mm)
- 002 = for cut leads, bulk (for $\varnothing 10 \dots 18$ mm)
- 003 = for crimped leads, blister (for $\varnothing 16 \dots 18$ mm)
- 004 = for J leads, blister (for $\varnothing 10 \dots 18$ mm, excluding $d \times l = 18 \times 40$ mm)
- 006 = for taped leads, Ammo pack, lead spacing $F = 3.5$ mm (for $\varnothing 8$ mm)
- 008 = for taped leads, Ammo pack, lead spacing $F = 5.0$ mm (for $\varnothing 8 \dots 12.5$ mm)
- 009 = for taped leads, Ammo pack, lead spacing $F = 7.5$ mm (for $d \times l = 16 \times 20 \dots 16 \times 31.5$ mm and $18 \times 20 \dots 18 \times 31.5$ mm)
- 012 = for bent 90° leads, blister (for $\varnothing 16 \dots 18$ mm)

B41866
High ripple current – 125 °C
Technical data and ordering codes

C_R 120 Hz 20 °C μF	Case dimensions $d \times l$ mm	ESR_{max} 10 kHz –40 °C Ω	ESR_{max} 10 kHz 20 °C Ω	Z_{max} 100 kHz 20 °C Ω	$I_{\text{AC,R}}$ 100 kHz 125 °C mA	Ordering code (composition see below)
$V_R = 25 \text{ V DC}$						
100	8 × 11.5	5.170	0.646	0.573	297	B41866C5107M***
120	8 × 11.5	5.170	0.646	0.573	297	B41866C5127M***
150	8 × 11.5	5.170	0.646	0.573	297	B41866C5157M***
180	8 × 11.5	5.170	0.646	0.573	297	B41866C5187M***
220	8 × 11.5	5.170	0.646	0.573	297	B41866C5227M***
270	10 × 12.5	2.980	0.373	0.336	450	B41866C5277M***
330	10 × 12.5	2.980	0.373	0.336	450	B41866C5337M***
390	10 × 16	1.404	0.175	0.160	714	B41866C5397M***
470	10 × 16	1.404	0.175	0.160	714	B41866C5477M***
560	10 × 20	1.070	0.134	0.127	875	B41866C5567M***
680	10 × 20	1.070	0.134	0.127	875	B41866C5687M***
820	12.5 × 20	0.881	0.110	0.104	1105	B41866C5827M***
1000	12.5 × 20	0.881	0.110	0.104	1105	B41866C5108M***
1200	12.5 × 25	0.710	0.089	0.082	1358	B41866C5128M***
1500	12.5 × 25	0.710	0.089	0.082	1358	B41866C5158M***
1800	16 × 20	0.401	0.050	0.046	1895	B41866C5188M***
2200	16 × 25	0.314	0.039	0.037	2279	B41866D5228M***
2200	18 × 20	0.341	0.043	0.040	2190	B41866E5228M***
2700	18 × 25	0.312	0.039	0.037	2454	B41866D5278M***
3300	16 × 31.5	0.248	0.031	0.029	2822	B41866D5338M***
3900	16 × 35.5	0.200	0.025	0.024	3230	B41866E5398M***
3900	18 × 31.5	0.224	0.028	0.027	3178	B41866D5398M***
4700	18 × 35	0.184	0.023	0.022	3638	B41866D5478M***
5600	18 × 40	0.152	0.019	0.018	4244	B41866C5568M***

Composition of ordering code

*** = Version

- 000 = for standard leads, bulk
- 001 = for kinked leads, bulk (for $d \times l = 10 \times 20 \text{ mm}$ and $\varnothing 12.5 \dots 18 \text{ mm}$)
- 002 = for cut leads, bulk (for $\varnothing 10 \dots 18 \text{ mm}$)
- 003 = for crimped leads, blister (for $\varnothing 16 \dots 18 \text{ mm}$)
- 004 = for J leads, blister (for $\varnothing 10 \dots 18 \text{ mm}$, excluding $d \times l = 18 \times 40 \text{ mm}$)
- 006 = for taped leads, Ammo pack, lead spacing $F = 3.5 \text{ mm}$ (for $\varnothing 8 \text{ mm}$)
- 008 = for taped leads, Ammo pack, lead spacing $F = 5.0 \text{ mm}$ (for $\varnothing 8 \dots 12.5 \text{ mm}$)
- 009 = for taped leads, Ammo pack, lead spacing $F = 7.5 \text{ mm}$ (for $d \times l = 16 \times 20 \dots 16 \times 31.5 \text{ mm}$ and $18 \times 20 \dots 18 \times 31.5 \text{ mm}$)
- 012 = for bent 90° leads, blister (for $\varnothing 16 \dots 18 \text{ mm}$)

Technical data and ordering codes

C_R 120 Hz 20 °C μF	Case dimensions $d \times l$ mm	ESR_{max} 10 kHz –40 °C Ω	ESR_{max} 10 kHz 20 °C Ω	Z_{max} 100 kHz 20 °C Ω	$I_{\text{AC,R}}$ 100 kHz 125 °C mA	Ordering code (composition see below)
$V_R = 35 \text{ V DC}$						
100	8 × 11.5	5.170	0.646	0.573	297	B41866C7107M***
120	8 × 11.5	5.170	0.646	0.573	297	B41866C7127M***
150	10 × 12.5	2.980	0.373	0.336	450	B41866C7157M***
180	10 × 12.5	2.980	0.373	0.336	450	B41866C7187M***
220	10 × 12.5	2.980	0.373	0.336	450	B41866C7227M***
270	10 × 16	1.404	0.175	0.160	714	B41866C7277M***
330	10 × 16	1.404	0.175	0.160	714	B41866C7337M***
390	10 × 20	1.070	0.134	0.127	875	B41866C7397M***
470	10 × 20	1.070	0.134	0.127	875	B41866C7477M***
560	12.5 × 20	0.881	0.110	0.104	1105	B41866C7567M***
680	12.5 × 20	0.881	0.110	0.104	1105	B41866C7687M***
820	12.5 × 25	0.710	0.089	0.082	1358	B41866C7827M***
1000	16 × 20	0.401	0.050	0.046	1895	B41866C7108M***
1200	16 × 25	0.314	0.039	0.037	2279	B41866C7128M***
1500	16 × 25	0.314	0.039	0.037	2279	B41866C7158M***
1500	18 × 20	0.341	0.043	0.040	2190	B41866D7158M***
1800	16 × 31.5	0.249	0.031	0.029	2822	B41866C7188M***
1800	18 × 25	0.314	0.039	0.037	2454	B41866D7188M***
2200	16 × 35.5	0.200	0.025	0.024	3230	B41866D7228M***
2200	18 × 31.5	0.226	0.028	0.027	3178	B41866C7228M***
2700	18 × 35	0.187	0.023	0.022	3638	B41866C7278M***
3300	18 × 40	0.153	0.019	0.018	4244	B41866C7338M***

Composition of ordering code

*** = Version

- 000 = for standard leads, bulk
- 001 = for kinked leads, bulk (for $d \times l = 10 \times 20 \text{ mm}$ and $\varnothing 12.5 \dots 18 \text{ mm}$)
- 002 = for cut leads, bulk (for $\varnothing 10 \dots 18 \text{ mm}$)
- 003 = for crimped leads, blister (for $\varnothing 16 \dots 18 \text{ mm}$)
- 004 = for J leads, blister (for $\varnothing 10 \dots 18 \text{ mm}$, excluding $d \times l = 18 \times 40 \text{ mm}$)
- 006 = for taped leads, Ammo pack, lead spacing $F = 3.5 \text{ mm}$ (for $\varnothing 8 \text{ mm}$)
- 008 = for taped leads, Ammo pack, lead spacing $F = 5.0 \text{ mm}$ (for $\varnothing 8 \dots 12.5 \text{ mm}$)
- 009 = for taped leads, Ammo pack, lead spacing $F = 7.5 \text{ mm}$ (for $d \times l = 16 \times 20 \dots 16 \times 31.5 \text{ mm}$ and $18 \times 20 \dots 18 \times 31.5 \text{ mm}$)
- 012 = for bent 90° leads, blister (for $\varnothing 16 \dots 18 \text{ mm}$)



B41866

High ripple current – 125 °C

Technical data and ordering codes

C_R 120 Hz 20 °C μF	Case dimensions $d \times l$ mm	ESR_{max} 10 kHz –40 °C Ω	ESR_{max} 10 kHz 20 °C Ω	Z_{max} 100 kHz 20 °C Ω	$I_{\text{AC,R}}$ 100 kHz 125 °C mA	Ordering code (composition see below)
$V_R = 50 \text{ V DC}$						
47	8 × 11.5	5.687	0.711	0.631	370	B41866C6476M***
56	8 × 11.5	5.429	0.679	0.602	370	B41866C6566M***
68	8 × 11.5	5.170	0.646	0.573	370	B41866C6686M***
82	8 × 11.5	5.170	0.646	0.573	370	B41866C6826M***
100	10 × 12.5	2.980	0.373	0.336	450	B41866C6107M***
120	10 × 16	1.404	0.175	0.160	714	B41866C6127M***
150	10 × 16	1.404	0.175	0.160	714	B41866C6157M***
180	10 × 20	1.070	0.134	0.127	875	B41866C6187M***
220	10 × 20	1.070	0.134	0.127	875	B41866C6227M***
270	10 × 20	1.070	0.134	0.127	875	B41866C6277M***
330	12.5 × 20	0.881	0.110	0.104	1105	B41866C6337M***
390	12.5 × 25	0.710	0.089	0.082	1358	B41866C6397M***
470	12.5 × 25	0.710	0.089	0.082	1358	B41866C6477M***
470	16 × 20	0.680	0.085	0.080	1370	B41866D6477M***
560	16 × 20	0.401	0.050	0.046	1895	B41866C6567M***
680	16 × 25	0.314	0.039	0.037	2279	B41866C6687M***
820	16 × 25	0.314	0.039	0.037	2279	B41866C6827M***
820	18 × 20	0.344	0.043	0.040	2190	B41866E6827M***
1000	16 × 31.5	0.249	0.031	0.029	2822	B41866C6108M***
1000	18 × 25	0.314	0.039	0.037	2454	B41866D6108M***
1200	16 × 35.5	0.200	0.025	0.024	3230	B41866D6128M***
1200	18 × 31.5	0.226	0.028	0.027	3178	B41866C6128M***
1500	18 × 35	0.187	0.023	0.022	3638	B41866C6158M***
1800	18 × 40	0.153	0.019	0.018	4244	B41866C6188M***

Composition of ordering code

*** = Version

- 000 = for standard leads, bulk
- 001 = for kinked leads, bulk (for $d \times l = 10 \times 20 \text{ mm}$ and $\varnothing 12.5 \dots 18 \text{ mm}$)
- 002 = for cut leads, bulk (for $\varnothing 10 \dots 18 \text{ mm}$)
- 003 = for crimped leads, blister (for $\varnothing 16 \dots 18 \text{ mm}$)
- 004 = for J leads, blister (for $\varnothing 10 \dots 18 \text{ mm}$, excluding $d \times l = 18 \times 40 \text{ mm}$)
- 006 = for taped leads, Ammo pack, lead spacing $F = 3.5 \text{ mm}$ (for $\varnothing 8 \text{ mm}$)
- 008 = for taped leads, Ammo pack, lead spacing $F = 5.0 \text{ mm}$ (for $\varnothing 8 \dots 12.5 \text{ mm}$)
- 009 = for taped leads, Ammo pack, lead spacing $F = 7.5 \text{ mm}$ (for $d \times l = 16 \times 20 \dots 16 \times 31.5 \text{ mm}$ and $18 \times 20 \dots 18 \times 31.5 \text{ mm}$)
- 012 = for bent 90° leads, blister (for $\varnothing 16 \dots 18 \text{ mm}$)

Technical data and ordering codes

C_R 120 Hz 20 °C μ F	Case dimensions $d \times l$ mm	ESR_{max} 10 kHz –40 °C Ω	ESR_{max} 10 kHz 20 °C Ω	Z_{max} 100 kHz 20 °C Ω	$I_{AC,R}$ 100 kHz 125 °C mA	Ordering code (composition see below)
-------------------------------------	--	---	--	---	---------------------------------------	---

 $V_R = 63$ V DC

100	10 × 16	2.560	0.320	0.300	670	B41866G8107M***
180	10 × 20	2.160	0.270	0.250	820	B41866G8187M***
220	12.5 × 20	1.760	0.220	0.200	1040	B41866G8227M***
330	12.5 × 20	1.760	0.220	0.200	1040	B41866G8337M***
470	16 × 20	0.728	0.091	0.085	1790	B41866G8477M***
680	16 × 25	0.536	0.067	0.061	2030	B41866H8687M***
680	18 × 20	0.600	0.075	0.070	1910	B41866J8687M***
820	16 × 31.5	0.472	0.059	0.053	2330	B41866G8827M***
1000	16 × 31.5	0.472	0.059	0.053	2330	B41866G8108M***
1200	18 × 31.5	0.368	0.046	0.041	2580	B41866G8128M***
1500	18 × 35	0.320	0.040	0.035	2890	B41866G8158M***
1800	18 × 40	0.280	0.035	0.030	3210	B41866G8188M***

 $V_R = 75$ V DC

270	16 × 20	0.880	0.110	0.102	1790	B41866G0277M***
330	16 × 25	0.640	0.080	0.073	2030	B41866G0337M***
330	18 × 25	0.720	0.090	0.084	1910	B41866H0337M***
470	16 × 31.5	0.568	0.071	0.064	2330	B41866G0477M***
470	18 × 25	0.520	0.065	0.059	2280	B41866H0477M***
680	18 × 31.5	0.440	0.055	0.049	2580	B41866G0687M***
820	18 × 35	0.384	0.048	0.042	2890	B41866G0827M***
1000	18 × 40	0.336	0.042	0.036	3210	B41866G0108M***

Composition of ordering code

*** = Version

- 000 = for standard leads, bulk
- 001 = for kinked leads, bulk (for $d \times l = 10 \times 20$ mm and $\varnothing 12.5 \dots 18$ mm)
- 002 = for cut leads, bulk (for $\varnothing 10 \dots 18$ mm)
- 003 = for crimped leads, blister (for $\varnothing 16 \dots 18$ mm)
- 004 = for J leads, blister (for $\varnothing 10 \dots 18$ mm, excluding $d \times l = 18 \times 40$ mm)
- 006 = for taped leads, Ammo pack, lead spacing $F = 3.5$ mm (for $\varnothing 8$ mm)
- 008 = for taped leads, Ammo pack, lead spacing $F = 5.0$ mm (for $\varnothing 8 \dots 12.5$ mm)
- 009 = for taped leads, Ammo pack, lead spacing $F = 7.5$ mm (for $d \times l = 16 \times 20 \dots 16 \times 31.5$ mm and $18 \times 20 \dots 18 \times 31.5$ mm)
- 012 = for bent 90° leads, blister (for $\varnothing 16 \dots 18$ mm)



B41866

High ripple current – 125 °C

Useful life¹⁾

depending on ambient temperature T_A under ripple current operating conditions

$d = 8 \text{ mm}$ and $V_R \leq 63 V_{DC}$

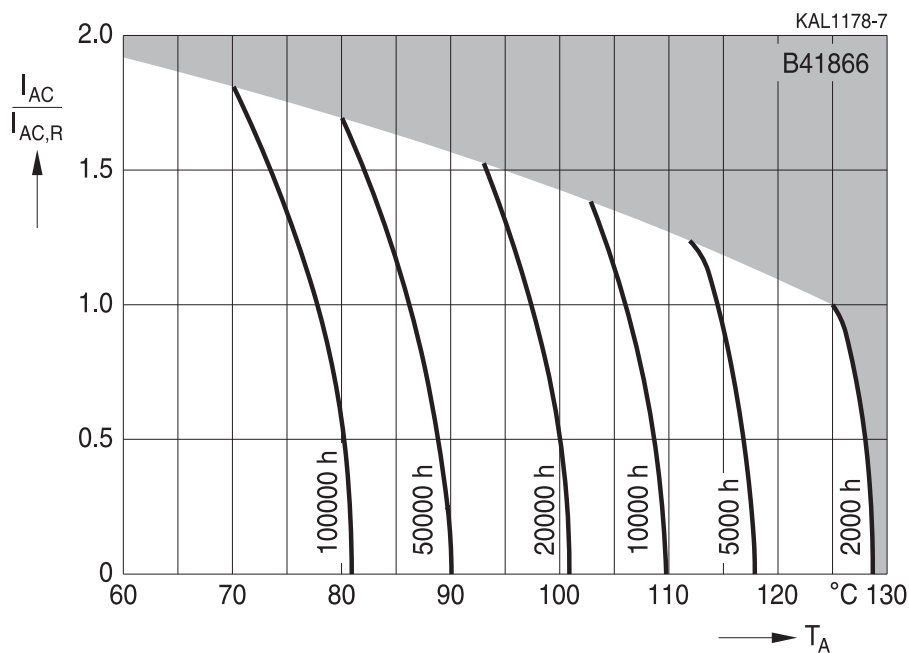

Useful life¹⁾

depending on ambient temperature T_A under ripple current operating conditions

$d = 10 \text{ mm}$ and $V_R \leq 63 V_{DC}$

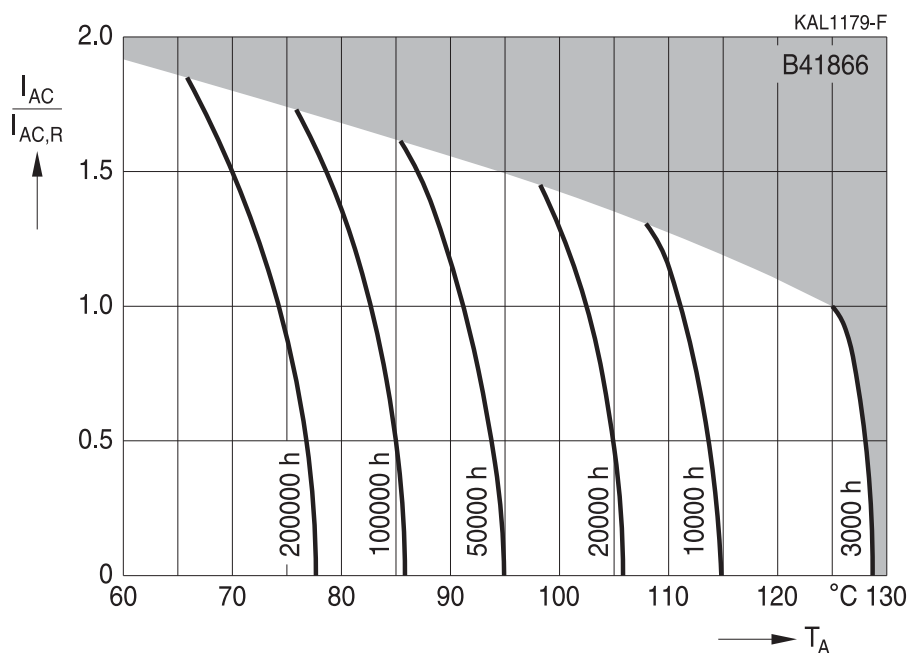

1) Refer to chapter "General technical information, 5 Useful life" on how to interpret useful life.



B41866
High ripple current – 125 °C

Useful life¹⁾

depending on ambient temperature T_A under ripple current operating conditions

$d \geq 12.5 \text{ mm}$ and $V_R \leq 63 V_{DC}$

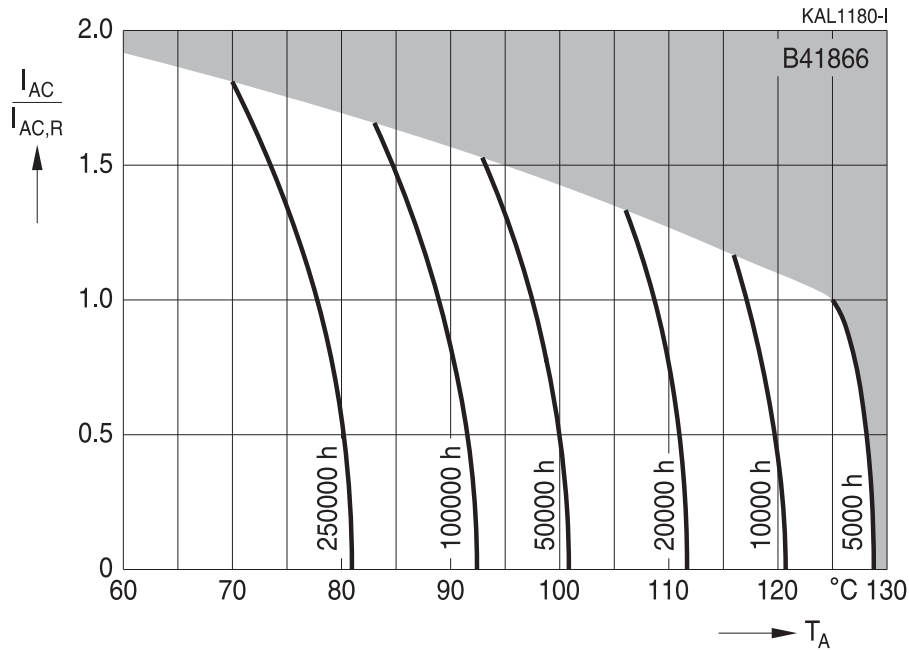

Useful life¹⁾

depending on ambient temperature T_A under ripple current operating conditions

$V_R = 75 V_{DC}$

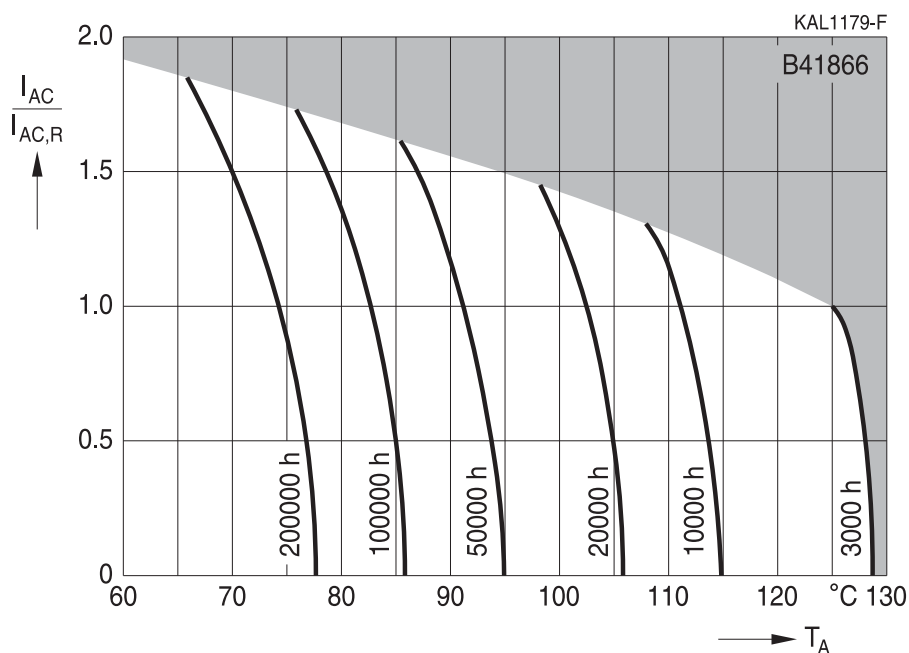

1) Refer to chapter "General technical information, 5 Useful life" on how to interpret useful life.

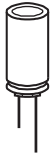

B41866

High ripple current – 125 °C

Frequency factor of permissible ripple current I_{AC} versus frequency f

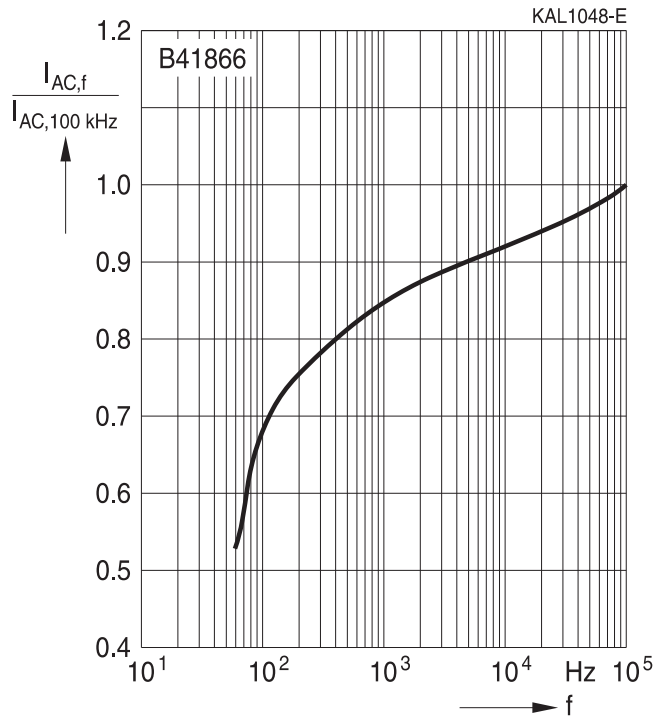



Taping

Single-ended capacitors are available taped in Ammo pack from diameter 8 to 18 mm as follows:

Lead spacing $F = 3.5$ mm ($\varnothing d = 8$ mm)

Lead spacing $F = 5.0$ mm ($\varnothing d = 8 \dots 12.5$ mm)

Lead spacing $F = 7.5$ mm ($\varnothing d = 16 \dots 18$ mm).

The dimensions for F , P_1 and 1 max. are specified with reference to the center of the terminal wires.

Lead spacing 3.5 mm ($\varnothing d = 8$ mm)

Last 3 digits of ordering code: 006



Dimensions in mm

$\varnothing d$	F	H	W	W_0	W_1	W_2	P	P_0	P_1	l_1	t	Δh	D_0
8	3.5	18.5	18.0	9.5	9.0	3.0	12.7	12.7	4.6	1.0	0.7	1.0	4.0
Tolerance	+0.8 -0.2	± 1.0	± 0.5	min.	± 0.5	max.	± 1.0	± 0.3	± 0.6	max.	± 0.2	max.	± 0.2

Leads can also run straight through the taping area.



B41866

High ripple current – 125 °C

Lead spacing 5.0 mm (∅ d = 8 mm)

Last 3 digits of ordering code: 008



Lead spacing 5.0 mm (∅ d = 10 ... 12.5 mm)

Last 3 digits of ordering code: 008



Dimensions in mm

∅ d	F	H	W	W ₀	W ₁	W ₂	H ₀	P	P ₀	P ₁	I ₁	t	Δh	D ₀
8		20.0		9.5			16.0	12.7	12.7	3.85				
10	5.0	19.0	18.0	9.5	9.0	1.5	—	12.7	12.7	3.85	1.0	0.6	1.0	4.0
12.5		19.0		11.5			—	15.0	15.0	5.0				
Tolerance	+0.8 -0.2	±0.75	±0.5	min.	±0.5	max.	±0.5	±1.0	±0.2	±0.5	max.	+0.3 -0.2	max.	±0.2

Taping is available up to dimensions d × l = 12.5 × 25 mm.

Lead spacing 7.5 mm ($\varnothing d = 16 \dots 18$ mm)

Last 3 digits of ordering code: 009

Dimensions in mm

$\varnothing d$	F	H	W	W_0	W_1	W_2	P	P_0	P_1	l_1	t	ΔP	Δh	D_0
16	7.5	18.5	18.0	12.5	9.0	1.5	30.0	15.0	3.75	1.0	0.7	0	0	4.0
18														
Tolerance	± 0.8	-0.5 $+0.75$	± 0.5	min.	± 0.5	max.	± 1.0	± 0.2	± 0.5	max.	± 0.2	± 1.0	± 1.0	± 0.2

 Taping is available up to dimensions $d \times l = 16 \times 31.5$ mm and 18×31.5 mm.



B41866

High ripple current – 125 °C

Cut or kinked leads

Single-ended capacitors are available with cut or kinked leads. Other lead configurations also available upon request.

Cut leads

Last 3 digits of ordering code: 002

With stand-off rubber seal

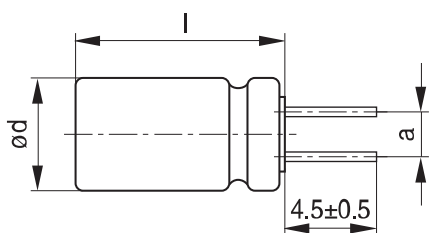

KAL1085-I

With flat rubber seal

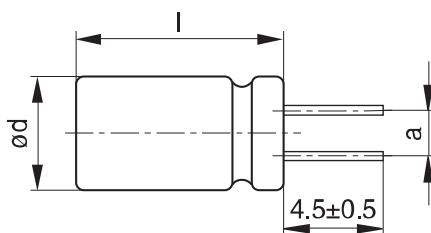

KAL1086-R

Case size d × l (mm)	Dimensions (mm) a ±0.5
10 × 12.5	5.0
10 × 16	5.0
10 × 20	5.0
12.5 × 20	5.0
12.5 × 25	5.0
16 × 20	7.5
16 × 25	7.5
16 × 31.5	7.5
16 × 35.5	7.5
16 × 40	7.5
18 × 20	7.5
18 × 25	7.5
18 × 31.5	7.5
18 × 35	7.5
18 × 40	7.5



Kinked leads

Last 3 digits of ordering code: 001

With stand-off rubber seal

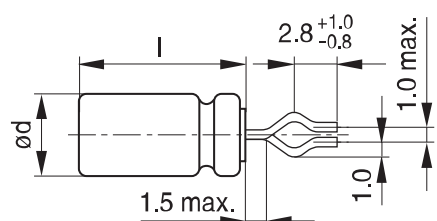

KAL1081-K

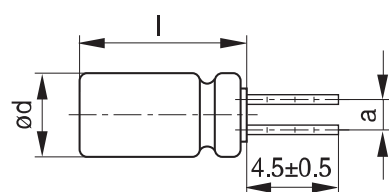

KAL1083-2

With flat rubber seal

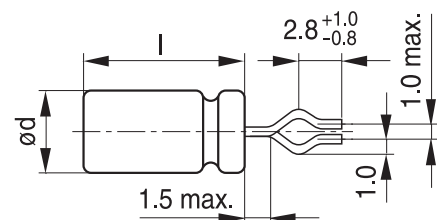

KAL1082-T

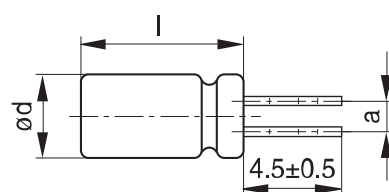

KAL1084-A

Case size d × l (mm)	Dimensions (mm) a ±0.5
10 × 20	5.0
12.5 × 20	5.0
12.5 × 25	5.0
16 × 20	7.5
16 × 25	7.5
16 × 31.5	7.5
16 × 35.5	7.5
18 × 20	7.5
18 × 25	7.5
18 × 31.5	7.5
18 × 35	7.5
18 × 40	7.5



B41866

High ripple current – 125 °C

PAPR leads (Protection Against Polarity Reversal)

These lead configurations ensure correct placement of the capacitor on the PCB with regard to polarity. PAPR leads are available for diameters from 10 mm up to 18 mm.

There are three configurations available: Crimped leads, J leads, bent 90° leads.

Crimped leads

Last 3 digits of ordering code: 003

With stand-off rubber seal



The series B41897 and B41898 have no sleeve nor minus pole marking, the positive pole is marked on the aluminum case side instead.

Suggestion for PCB hole diameter

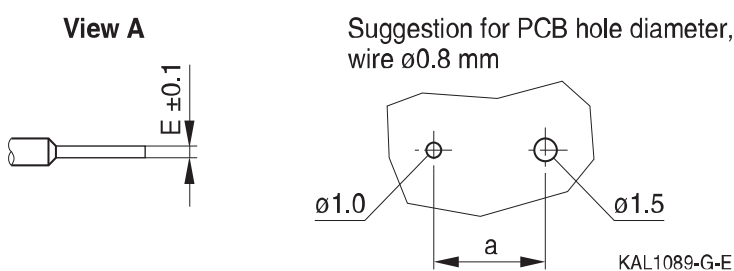

Case size d × l (mm)	Dimensions (mm)					
	B ±0.2	C ±0.5	D ±0.1	E ±0.1	a ±0.5	Øb
16 × 20	1.5	3.0	1.3	0.3	7.5	0.8 ±0.05
16 × 25	1.5	3.0	1.3	0.3	7.5	0.8 ±0.05
16 × 31.5	1.5	3.0	1.3	0.3	7.5	0.8 ±0.05
16 × 35.5	1.5	3.0	1.3	0.3	7.5	0.8 ±0.05
18 × 20	1.5	3.0	1.3	0.3	7.5	0.8 ±0.1
18 × 25	1.5	3.0	1.3	0.3	7.5	0.8 ±0.1
18 × 31.5	1.5	3.0	1.3	0.3	7.5	0.8 ±0.1
18 × 35	1.5	3.0	1.3	0.3	7.5	0.8 ±0.1
18 × 40	1.5	3.0	1.3	0.3	7.5	0.8 ±0.1



J leads

Last 3 digits of ordering code: 004

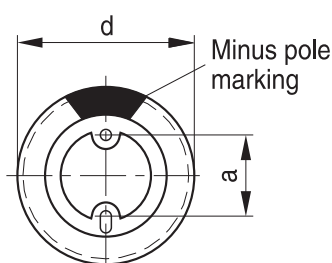

KAL1091-S-E

The series B41897 and B41898 have no sleeve nor minus pole marking, the positive pole is marked on the aluminum case side instead.

Suggestion for PCB hole diameter

Suggestion for PCB hole diameter, wire $\varnothing 0.6$ mm



Suggestion for PCB hole diameter, wire $\varnothing 0.8$ mm



Case size $d \times l$ (mm)	Dimensions (mm)				
	$C \pm 0.5$	$E \pm 0.5$	$J \pm 0.2$	$a \pm 0.5$	$\varnothing b$
10 × 12.5	3.2	0.7	1.2	5.0	0.6 ± 0.05
10 × 16	3.2	0.7	1.2	5.0	0.6 ± 0.05
10 × 20	3.2	0.7	1.2	5.0	0.6 ± 0.05
12.5 × 20	3.2	0.7	1.2	5.0	0.6 ± 0.05
12.5 × 25	3.2	0.7	1.2	5.0	0.6 ± 0.05
16 × 20	3.5	0.7	1.6	7.5	0.8 ± 0.05
16 × 25	3.5	0.7	1.6	7.5	0.8 ± 0.05
16 × 31.5	3.5	0.7	1.6	7.5	0.8 ± 0.05
16 × 35.5	3.5	0.7	1.6	7.5	0.8 ± 0.05
16 × 40	3.5	0.7	1.6	7.5	0.8 ± 0.05
18 × 20	3.5	0.7	1.6	7.5	0.8 ± 0.1
18 × 25	3.5	0.7	1.6	7.5	0.8 ± 0.1
18 × 31.5	3.5	0.7	1.6	7.5	0.8 ± 0.1
18 × 35	3.5	0.7	1.6	7.5	0.8 ± 0.1



B41866

High ripple current – 125 °C

Bent 90° leads for horizontal mounting pinning

Last 3 digits of ordering code: 012

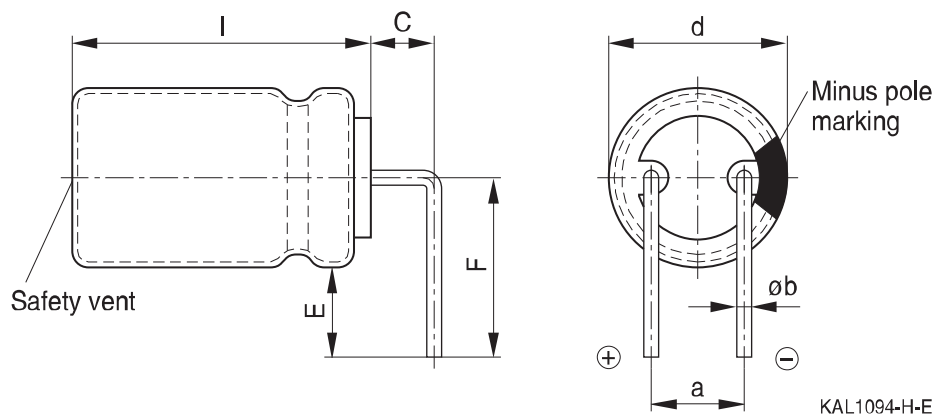

The series B41897 and B41898 have no sleeve nor minus pole marking, the positive pole is marked on the aluminum case side instead.

Case size d × l (mm)	Dimensions (mm)				
	C ±0.5	E ±0.5	F ±0.5	a ±0.5	Øb
16 × 20	4.0	4.0	12.0	7.5	0.8 ±0.05
16 × 25	4.0	4.0	12.0	7.5	0.8 ±0.05
16 × 31.5	4.0	4.0	12.0	7.5	0.8 ±0.05
16 × 35.5	4.0	4.0	12.0	7.5	0.8 ±0.05
16 × 40	4.0	4.0	13.0	7.5	0.8 ±0.05
18 × 20	4.0	4.0	13.0	7.5	0.8 ±0.1
18 × 25	4.0	4.0	13.0	7.5	0.8 ±0.1
18 × 31.5	4.0	4.0	13.0	7.5	0.8 ±0.1
18 × 35	4.0	4.0	13.0	7.5	0.8 ±0.1
18 × 40	4.0	4.0	13.0	7.5	0.8 ±0.1

Bent leads for diameter 12.5 mm available upon request.



Packing units and box dimensions

Ammo pack



Case size d × l mm	Dimensions (mm)			Packing units pcs.
	A _{max}	B _{max}	C _{max}	
8 × 11.5	345	60	240	1000
10 × 12.5	345	60	280	750
10 × 16	345	65	200	500
10 × 20	345	65	200	500
12.5 × 20	345	65	260	500
12.5 × 25	345	70	260	500
16 × 20	325	65	285	300
16 × 25	325	65	285	300
16 × 31.5	325	80	275	300
18 × 20	325	65	285	250
18 × 25	325	65	285	250
18 × 31.5	325	80	275	250



B41866

High ripple current – 125 °C

Overview of packing units and code numbers

Case size d × l mm	Standard, bulk pcs.	Taped, Ammo pack pcs.			Kinked leads, bulk pcs.	Cut leads, bulk pcs.	PAPR		
							Crimped leads, blister pcs.	J leads, blister pcs.	Bent 90° leads, blister pcs.
8 × 11.5	1000	1000			–	–	–	–	
10 × 12.5	1000	750			–	1000	–	900	
10 × 16	1000	500			–	1000	–	675	
10 × 20	500	500			500	500	–	500	
12.5 × 20	350	500			350	350	–	300	1)
12.5 × 25	250	500			500	500	–	225	1)
16 × 20	250	300			200	200	200	200	420
16 × 25	250	300			200	200	216	216	216
16 × 31.5	200	300			250	250	180	180	180
16 × 35.5	100	–			100	100	150	150	150
16 × 40	125	–			100	100	72	72	72
18 × 20	175	250			175	175	200	200	420
18 × 25	150	250			150	150	200	200	200
18 × 31.5	100	250			100	100	150	150	150
18 × 35	100	–			100	100	150	150	150
18 × 40	125	–			100	100	72	–	72
The last three digits of the complete ordering code state the lead configuration	000	Code	F (mm)	d (mm)	001	002	003	004	012
		006	3.5	8					
		008	5	8...12.5					
		009	7.5	16...18					

1) Available upon request



Cautions and warnings

Personal safety

The electrolytes used have been optimized both with a view to the intended application and with regard to health and environmental compatibility. They do not contain any solvents that are detrimental to health, e.g. dimethyl formamide (DMF) or dimethyl acetamide (DMAC). Furthermore, some of the high-voltage electrolytes used are self-extinguishing.

As far as possible, we do not use any dangerous chemicals or compounds to produce operating electrolytes, although in exceptional cases, such materials must be used in order to achieve specific physical and electrical properties because no alternative materials are currently known. We do, however, restrict the amount of dangerous materials used in our products to an absolute minimum.

Materials and chemicals used in our aluminum electrolytic capacitors are continuously adapted in compliance with the TDK Electronics Corporate Environmental Policy and the latest EU regulations and guidelines such as RoHS, REACH/SVHC, GADSL, and ELV.

MDS (Material Data Sheets) are available on our website for all types listed in the data book. MDS for customer specific capacitors are available upon request.

MSDS (Material Safety Data Sheets) are available for our electrolytes upon request.

Nevertheless, the following rules should be observed when handling aluminum electrolytic capacitors: No electrolyte should come into contact with eyes or skin. If electrolyte does come into contact with the skin, wash the affected areas immediately with running water. If the eyes are affected, rinse them for 10 minutes with plenty of water. If symptoms persist, seek medical treatment. Avoid inhaling electrolyte vapor or mists. Workplaces and other affected areas should be well ventilated. Clothing that has been contaminated by electrolyte must be changed and rinsed in water.



B41866

High ripple current – 125 °C

Product safety

The table below summarizes the safety instructions that must be observed without fail. A detailed description can be found in the relevant sections of separate file chapter "General technical information".

Topic	Safety information	Reference chapter "General technical information"
Polarity	Make sure that polar capacitors are connected with the right polarity.	1 "Basic construction of aluminum electrolytic capacitors"
Reverse voltage	Voltages of opposite polarity should be prevented by connecting a diode.	3.1.6 "Reverse voltage"
Mounting position of screw-terminal capacitors	Screw terminal capacitors must not be mounted with terminals facing down unless otherwise specified.	11.1. "Mounting positions of capacitors with screw terminals"
Robustness of terminals	The following maximum tightening torques must not be exceeded when connecting screw terminals: M5: 2.5 Nm M6: 4.0 Nm	11.3 "Mounting torques"
Mounting of single-ended capacitors	The internal structure of single-ended capacitors might be damaged if excessive force is applied to the lead wires. Avoid any compressive, tensile or flexural stress. Do not move the capacitor after soldering to PC board. Do not pick up the PC board by the soldered capacitor. Do not insert the capacitor on the PC board with a hole space different to the lead space specified.	11.4 "Mounting considerations for single-ended capacitors"
Soldering	Do not exceed the specified time or temperature limits during soldering.	11.5 "Soldering"
Soldering, cleaning agents	Do not allow halogenated hydrocarbons to come into contact with aluminum electrolytic capacitors.	11.6 "Cleaning agents"
Upper category temperature	Do not exceed the upper category temperature.	7.2 "Maximum permissible operating temperature"
Passive flammability	Avoid external energy, e.g. fire.	8.1 "Passive flammability"



Topic	Safety information	Reference chapter "General technical information"
Active flammability	Avoid overload of the capacitors.	8.2 "Active flammability"
Maintenance	Make periodic inspections of the capacitors. Before the inspection, make sure that the power supply is turned off and carefully discharge the capacitors. Do not apply excessive mechanical stress to the capacitor terminals when mounting.	10 "Maintenance"
Storage	Do not store capacitors at high temperatures or high humidity. Capacitors should be stored at +5 to +35 °C and a relative humidity of ≤ 75%.	7.3 "Shelf life and storage conditions"
		Reference chapter "Capacitors with screw terminals"
Breakdown strength of insulating sleeves	Do not damage the insulating sleeve, especially when ring clips are used for mounting.	"Screw terminals – accessories"

Display of ordering codes for TDK Electronics products

The ordering code for one and the same product can be represented differently in data sheets, data books, other publications, on the company website, or in order-related documents such as shipping notes, order confirmations and product labels. The varying representations of the ordering codes are due to different processes employed and do not affect the specifications of the respective products.

Detailed information can be found on the Internet under www.tdk-electronics.tdk.com/orderingcodes.



B41866

High ripple current – 125 °C

Symbols and terms

Symbol	English	German
C	Capacitance	Kapazität
C_R	Rated capacitance	Nennkapazität
C_S	Series capacitance	Serienkapazität
$C_{S,T}$	Series capacitance at temperature T	Serienkapazität bei Temperatur T
C_f	Capacitance at frequency f	Kapazität bei Frequenz f
d	Case diameter, nominal dimension	Gehäusedurchmesser, Nennmaß
d_{max}	Maximum case diameter	Maximaler Gehäusedurchmesser
ESL	Self-inductance	Eigeninduktivität
ESR	Equivalent series resistance	Ersatzserienwiderstand
ESR_f	Equivalent series resistance at frequency f	Ersatzserienwiderstand bei Frequenz f
ESR_T	Equivalent series resistance at temperature T	Ersatzserienwiderstand bei Temperatur T
f	Frequency	Frequenz
I	Current	Strom
I_{AC}	Alternating current (ripple current)	Wechselstrom
$I_{AC,RMS}$	Root-mean-square value of alternating current	Wechselstrom, Effektivwert
$I_{AC,f}$	Ripple current at frequency f	Wechselstrom bei Frequenz f
$I_{AC,max}$	Maximum permissible ripple current	Maximal zulässiger Wechselstrom
$I_{AC,R}$	Rated ripple current	Nennwechselstrom
I_{leak}	Leakage current	Reststrom
$I_{leak,op}$	Operating leakage current	Betriebsreststrom
l	Case length, nominal dimension	Gehäuselänge, Nennmaß
l_{max}	Maximum case length (without terminals and mounting stud)	Maximale Gehäuselänge (ohne Anschlüsse und Gewindebolzen)
R	Resistance	Widerstand
R_{ins}	Insulation resistance	Isolationswiderstand
R_{symm}	Balancing resistance	Symmetrierwiderstand
T	Temperature	Temperatur
ΔT	Temperature difference	Temperaturdifferenz
T_A	Ambient temperature	Umgebungstemperatur
T_C	Case temperature	Gehäusetemperatur
T_B	Capacitor base temperature	Temperatur des Gehäusebodens
t	Time	Zeit
Δt	Period	Zeitraum
t_b	Service life (operating hours)	Brauchbarkeitsdauer (Betriebszeit)



Symbol	English	German
V	Voltage	Spannung
V_F	Forming voltage	Formierspannung
V_{op}	Operating voltage	Betriebsspannung
V_R	Rated voltage, DC voltage	Nennspannung, Gleichspannung
V_S	Surge voltage	Spitzenspannung
X_C	Capacitive reactance	Kapazitiver Blindwiderstand
X_L	Inductive reactance	Induktiver Blindwiderstand
Z	Impedance	Scheinwiderstand
Z_T	Impedance at temperature T	Scheinwiderstand bei Temperatur T
$\tan \delta$	Dissipation factor	Verlustfaktor
λ	Failure rate	Ausfallrate
ϵ_0	Absolute permittivity	Elektrische Feldkonstante
ϵ_r	Relative permittivity	Dielektrizitätszahl
ω	Angular velocity; $2 \cdot \pi \cdot f$	Kreisfrequenz; $2 \cdot \pi \cdot f$

Note

All dimensions are given in mm.

Important notes

The following applies to all products named in this publication:

1. Some parts of this publication contain **statements about the suitability of our products for certain areas of application**. These statements are based on our knowledge of typical requirements that are often placed on our products in the areas of application concerned. We nevertheless expressly point out **that such statements cannot be regarded as binding statements about the suitability of our products for a particular customer application**. As a rule, we are either unfamiliar with individual customer applications or less familiar with them than the customers themselves. For these reasons, it is always ultimately incumbent on the customer to check and decide whether a product with the properties described in the product specification is suitable for use in a particular customer application.
2. We also point out that **in individual cases, a malfunction of electronic components or failure before the end of their usual service life cannot be completely ruled out in the current state of the art, even if they are operated as specified**. In customer applications requiring a very high level of operational safety and especially in customer applications in which the malfunction or failure of an electronic component could endanger human life or health (e.g. in accident prevention or lifesaving systems), it must therefore be ensured by means of suitable design of the customer application or other action taken by the customer (e.g. installation of protective circuitry or redundancy) that no injury or damage is sustained by third parties in the event of malfunction or failure of an electronic component.
3. **The warnings, cautions and product-specific notes must be observed.**
4. In order to satisfy certain technical requirements, **some of the products described in this publication may contain substances subject to restrictions in certain jurisdictions (e.g. because they are classed as hazardous)**. Useful information on this will be found in our Material Data Sheets on the Internet (www.tdk-electronics.tdk.com/material). Should you have any more detailed questions, please contact our sales offices.
5. We constantly strive to improve our products. Consequently, **the products described in this publication may change from time to time**. The same is true of the corresponding product specifications. Please check therefore to what extent product descriptions and specifications contained in this publication are still applicable before or when you place an order. We also **reserve the right to discontinue production and delivery of products**. Consequently, we cannot guarantee that all products named in this publication will always be available. The aforementioned does not apply in the case of individual agreements deviating from the foregoing for customer-specific products.
6. Unless otherwise agreed in individual contracts, **all orders are subject to our General Terms and Conditions of Supply**.

Important notes

7. **Our manufacturing sites serving the automotive business apply the IATF 16949 standard.** The IATF certifications confirm our compliance with requirements regarding the quality management system in the automotive industry. Referring to customer requirements and customer specific requirements (“CSR”) TDK always has and will continue to have the policy of respecting individual agreements. Even if IATF 16949 may appear to support the acceptance of unilateral requirements, we hereby like to emphasize that **only requirements mutually agreed upon can and will be implemented in our Quality Management System.** For clarification purposes we like to point out that obligations from IATF 16949 shall only become legally binding if individually agreed upon.
8. The trade names EPCOS, CeraCharge, CeraDiode, CeraLink, CeraPad, CeraPlas, CSMP, CTVS, DeltaCap, DigiSiMic, ExoCore, FilterCap, FormFit, LeaXield, MiniBlue, MiniCell, MKD, MKK, MotorCap, PCC, PhaseCap, PhaseCube, PhaseMod, PhiCap, PowerHap, PQSine, PQvar, SIFERRIT, SIFI, SIKOREL, SilverCap, SIMDAD, SiMic, SIMID, SineFormer, SIOV, ThermoFuse, WindCap are **trademarks registered or pending** in Europe and in other countries. Further information will be found on the Internet at www.tdk-electronics.tdk.com/trademarks.

Release 2018-10