

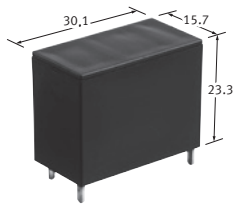

Load for solar inverter, Compact size, 1 Form A 22A/33A power relays

LF-G RELAYS(ALFG)

Protective construction : Flux-resistant type



(Unit : mm)

FEATURES

1. High capacity

High capacity control possible at 22A/33A (High capacity type) 250V AC rating in compact size (L: 15.7 × W: 30.1 × H: 23.3 mm L: .618 × W: 1.185 × H: .917 inch)

2. Contact gap: 1.5 mm .059 inch and 1.8 mm*** .071 inch

Compliant with European photovoltaic standard (IEC62109* and VDE0126**).

* Safety standard of PV power inverter

**German safety standard of PV power inverter

***Due to addition of altitude stipulation (2,000 m 6,561.68 ft or more) to IEC62109.

EN61810-1 certified: 2.5 kV surge breakdown voltage (between contacts)

3. Long insulation distance

Creepage distance between contact and coil terminal: Min. 9.5 mm .354 inch

Clearance distance between contact and coil terminal: Min. 6.5 mm .256 inch

Surge breakdown voltage: 6 kV

4. Coil holding voltage contributes to saving energy of equipment

The coil holding voltage can be reduced up to 35%V of the nominal coil voltage (Ambient temperature: 20°C 68°F).

Power consumption at the lowest coil holding voltage: 170 mW equivalent

*Coil holding voltage is the coil voltage after 100 ms from the applied nominal coil voltage.

*When the ambient temperature during use is 85°C 185°F, make the coil holding voltage between 45% and 80%V of the nominal coil voltage.

5. Conforms to various safety standards

UL/C-UL and VDE approved

TYPICAL APPLICATIONS

1. Photovoltaic power generation systems (Solar inverter)
2. Uninterruptible Power Supplies (UPS)
3. Home appliances
4. Office equipment

ORDERING INFORMATION

ALFG

P F

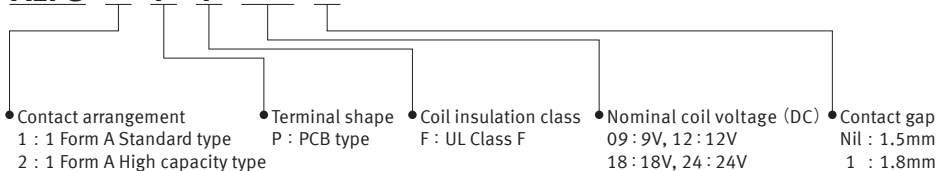

Note : Certified by UL/C-UL and VDE

TYPES

Contact arrangement	Nominal coil voltage	Part No.			
		Contact Gap 1.5 mm .059 inch type		Contact Gap 1.8 mm .071 inch type	
		Standard type	High capacity type	Standard type	High capacity type
1 Form A	9V DC	ALFG1PF09	ALFG2PF09	ALFG1PF091	ALFG2PF091
	12V DC	ALFG1PF12	ALFG2PF12	ALFG1PF121	ALFG2PF121
	18V DC	ALFG1PF18	ALFG2PF18	ALFG1PF181	ALFG2PF181
	24V DC	ALFG1PF24	ALFG2PF24	ALFG1PF241	ALFG2PF241

Standard packing: Carton: 50 pcs.; Case: 200 pcs.

RATING

1. Coil data

- Operating characteristics such as 'Operate voltage' and 'Release voltage' are influenced by mounting conditions, ambient temperature, etc. Therefore, please use the relay within $\pm 5\%$ of rated coil voltage.
- 'Initial' means the condition of products at the time of delivery.

Nominal coil voltage	Pick-up voltage (at 20°C 68°F) (Initial)	Drop-out voltage (at 20°C 68°F) (Initial)	Nominal operating current [$\pm 10\%$] (at 20°C 68°F)	Coil resistance [$\pm 10\%$] (at 20°C 68°F)	Nominal operating power	Max. applied voltage (at 20°C 68°F)
9V DC	70%V or less of nominal voltage	10%V or more of nominal voltage	155mA	58Ω	1,400mW	120%V of nominal voltage
12V DC			117mA	103Ω		
18V DC			78mA	230Ω		
24V DC			59mA	410Ω		

2. Specifications

Characteristics	Item	Specifications		
		Standard type		High capacity type
		Contact Gap 1.5 mm .059 inch type	Contact Gap 1.8 mm .071 inch type	Contact Gap 1.5 mm .059 inch type
Contact	Arrangement	1 Form A		
	Contact resistance (Initial)	Max. 100 mΩ (By voltage drop 6 V DC 1A)		
	Contact material	AgSnO ₂ type		
Rating	Nominal switching capacity	22A 250V AC	31A 250V AC	33A 250V AC
	Max. switching power	5,500VA	7,750VA	8,250VA
	Max. switching voltage	250V AC		
	Max. switching current	22A (AC)	31A (AC)	33A (AC)
	Nominal operating power	1,400mW		
	Min. switching capacity (Reference value)*1	100mA 5V DC		
Electrical characteristics	Insulation resistance (Initial)	Min. 1,000MΩ (at 500V DC) Measurement at same location as "Breakdown voltage" section.		
	Breakdown voltage (Initial)	Between open contacts	2,500 Vrms for 1 min. (Detection current: 10 mA)	
		Between contact and coil	4,000 Vrms for 1 min. (Detection current: 10 mA)	
	Surge breakdown voltage*2 (Between contact and coil) (Initial)	6,000 V		
	Coil holding voltage*3	35 to 120%V (contact carrying current: 22A, at 20°C 68°F) 45 to 80%V (contact carrying current: 22A, at 85°C 185°F)	35 to 120%V (contact carrying current: 31A, at 20°C 68°F) 45 to 80%V (contact carrying current: 31A, at 85°C 185°F)	35 to 120%V (contact carrying current: 33A, at 20°C 68°F) 45 to 80%V (contact carrying current: 33A, at 85°C 185°F)
	Operate time (at 20°C 68°F) (Initial)	Max. 20 ms (at nominal coil voltage excluding contact bounce time.)		
Release time (at 20°C 68°F) (Initial)	Max. 10 ms (at nominal coil voltage excluding contact bounce time, without diode)			
Mechanical characteristics	Shock resistance	Functional	Min. 100 m/s ² (Half-wave pulse of sine wave: 11 ms; detection time: 10μs.)	
		Destructive	Min. 1,000 m/s ² (Half-wave pulse of sine wave: 6 ms.)	
	Vibration resistance	Functional	10 to 55 Hz at double amplitude of 1.5 mm (Detection time: 10μs.)	
Destructive		10 to 55 Hz at double amplitude of 1.5 mm		
Expected life	Mechanical		Contact Gap 1.5 mm .059 inch type: Min. 10 ⁶ (at 180 times/min.) Contact Gap 1.8 mm .071 inch type: Min. 5×10 ⁵ (at 180 times/min.)	
	Electrical	Resistive load	22A 250V AC, Min. 3×10 ⁴ (at 20 times/min.)	—
		Inductive load	Destructive: 22A 250V AC (cosφ = 0.8), Min. 3×10 ⁴ (on:off = 0.1s:10s) Over load: 35A 250V AC (cosφ = 0.8), Min. 50 (on:off = 0.1s:10s)	Destructive: 31A 250V AC (cosφ = 0.8), Min. 3×10 ⁴ (on:off = 0.1s:10s) Over load: 47A 250V AC (cosφ = 0.8), Min. 50 (on:off = 0.1s:10s)
Conditions	Conditions for operation, transport and storage*4	Ambient temperature: -40°C to +60°C -40°F to +140°F (When nominal coil voltage applied) -40°C to +85°C -40°F to +185°F (Coil holding voltage is when 45 to 80%V of nominal coil voltage is applied.) Humidity: 5 to 85% R.H. (Not freezing and condensing at low temperature) Air pressure: 86 to 106 kPa		
Unit weight	Approx. 23 g .81 oz			

Notes: *1. This value can change due to the switching frequency, environmental conditions, and desired reliability level, therefore it is recommended to check this with the actual load.

*2. Wave is standard shock voltage of $\pm 1.2 \times 50\mu s$ according to JEC-212-1981

*3. Coil holding voltage is the coil voltage after 100 ms from the applied nominal coil voltage.

*4. The upper limit of the ambient temperature is the maximum temperature that can satisfy the coil temperature rise value. Refer to Usage, transport and storage conditions in NOTES.

REFERENCE DATA

1. Standard type (Contact Gap 1.5 mm .059 inch type) (Contact Gap 1.8 mm .071 inch type)

1. Coil temperature rise

Tested sample : ALFG1PF09, ALFG1PF091, 6 pcs.
 Measured portion : Coil inside
 Contact current : 22A
 Ambient temperature : 20°C, 60°C

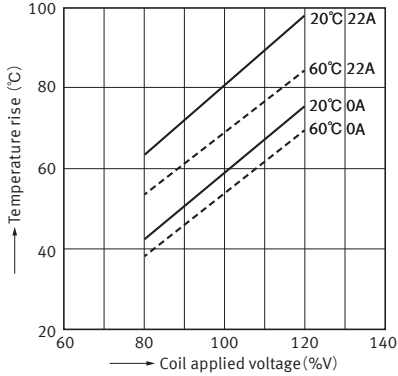

2. Ambient temperature characteristics and coil

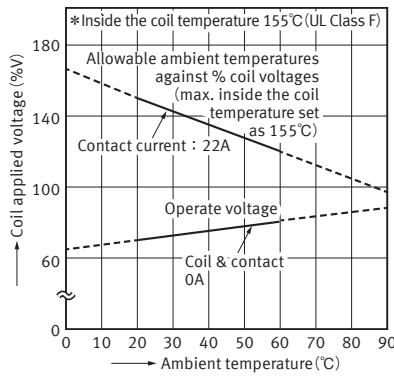

3. Electrical life test (22A 250V AC Resistive load)

Tested sample : ALFG1PF09, ALFG1PF091, 6 pcs.
 Operation frequency : ON : OFF = 1.5s : 1.5s
 Ambient temperature : 85°C
 Circuit :

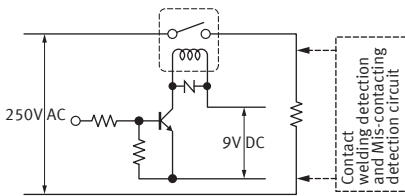

Change of operate and release voltage

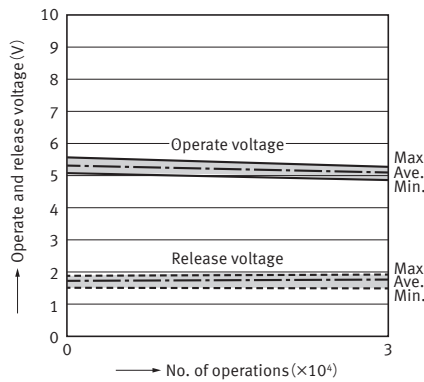

Change of contact resistance

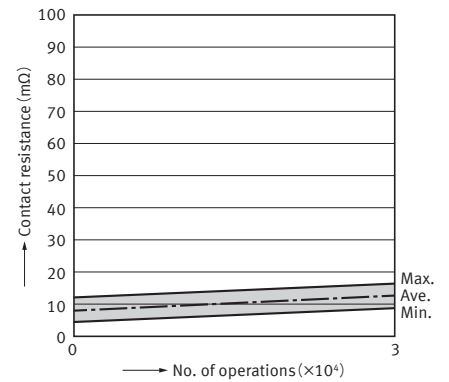

4. Electrical life test (22A 250V AC cosφ = 0.8 Inductive load)

Tested sample : ALFG1PF09, ALFG1PF091, 6 pcs.
 Operation frequency : ON : OFF = 0.1s : 10s
 Ambient temperature : 85°C
 Circuit :

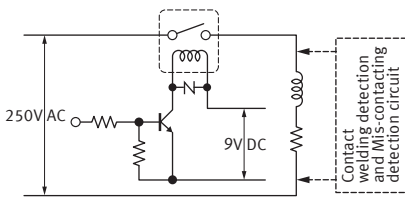

Change of operate and release voltage

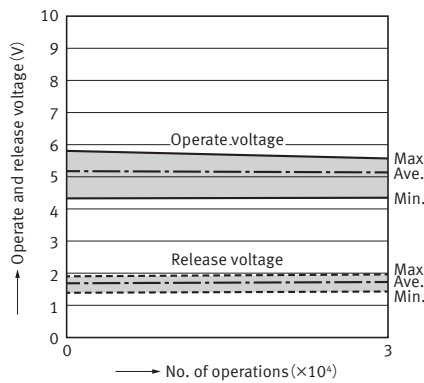

Change of contact resistance

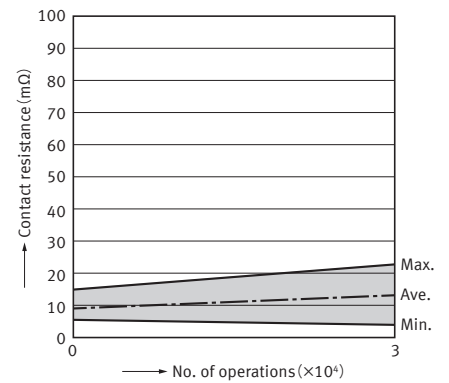

2. High capacity type (Contact Gap 1.5 mm .059 inch type)

1. Coil temperature rise

Tested sample : ALFG2PF09, 6 pcs.
 Measured portion : Coil inside
 Contact current : 31A
 Ambient temperature : 20°C, 60°C

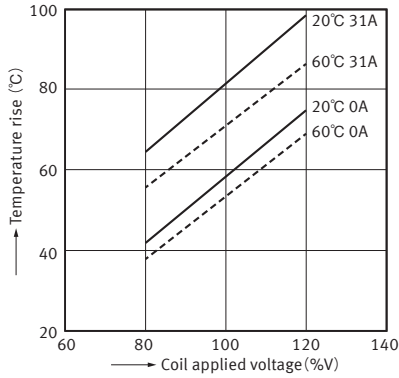

2. Ambient temperature characteristics and coil applied voltage

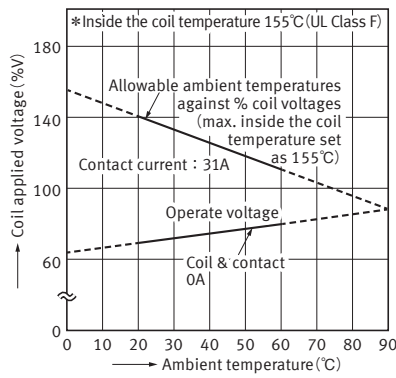

3. Electrical life test

(31A 250V AC cosφ = 0.8 Inductive load)

Tested sample : ALFG2PF09, 6 pcs.
 Operation frequency : ON : OFF = 0.1s : 10s
 Ambient temperature : 85°C
 Circuit :

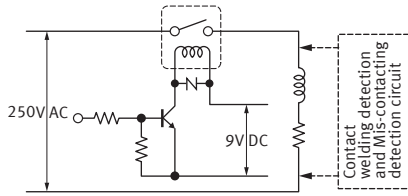

Change of operate and release voltage

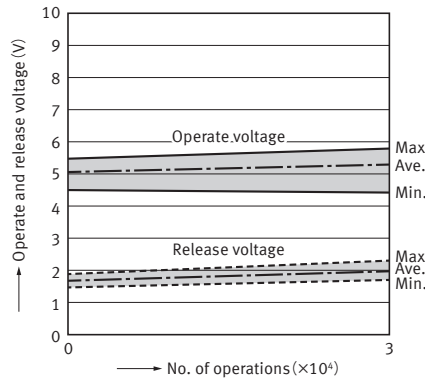

Change of contact resistance

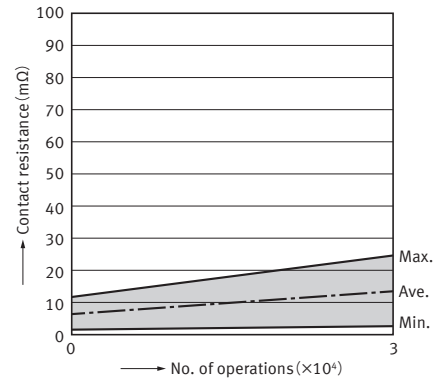

3. High capacity type (Contact Gap 1.8 mm .071 inch type)

1. Coil temperature rise

Tested sample : ALFG2PF091, 6 pcs.
 Measured portion : Coil inside
 Contact current : 33A
 Ambient temperature : 20°C, 60°C

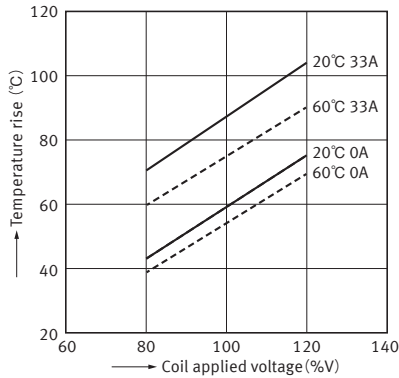

2. Ambient temperature characteristics and coil applied voltage

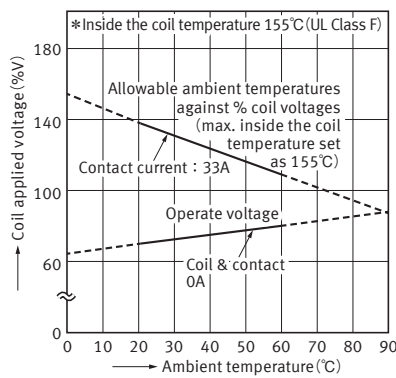

3. Electrical life test

(33A 250V AC cosφ = 0.8 Inductive load)

Tested sample : ALFG2PF091, 6 pcs.
 Operation frequency : ON : OFF = 0.1s : 10s
 Ambient temperature : 85°C
 Circuit :

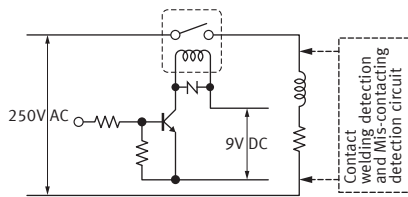

Change of operate and release voltage

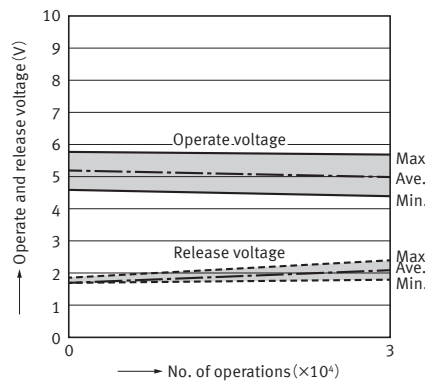

Change of contact resistance

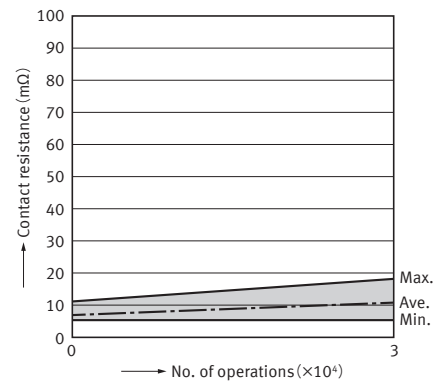

DIMENSIONS (mm)

CAD The CAD data of the products with a "CAD" mark can be downloaded from our Website.

CAD



External dimensions

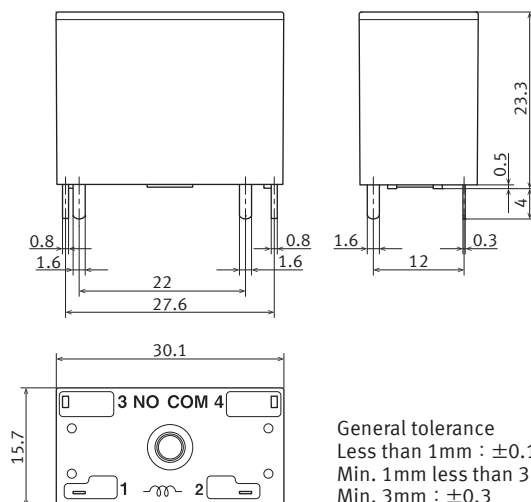

PC board pattern (Bottom view)

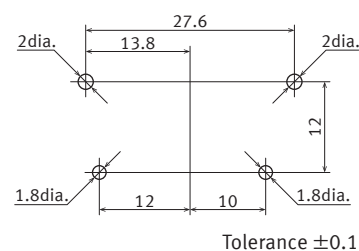

Schematic (Bottom view)

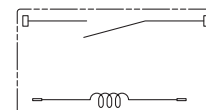

General tolerance
 Less than 1mm : ±0.1
 Min. 1mm less than 3mm : ±0.2
 Min. 3mm : ±0.3

SAFETY STANDARDS

Item	UL/C-UL (Recognized)				VDE (VDE0435) (Certified)				
	File No.	Contact rating	Temp.	Cycles	File No.	Contact rating	Temp.	Cycles	
Standard type (Contact GAP 1.5 mm/1.8 mm .059 inch/.071 inch)	E43028	22A 277V AC General Use	85°C 185°F	3 × 10 ⁴	40023067	22A 250V AC (cosφ=0.8)	85°C 185°F	3 × 10 ⁴	
		22A 277V AC Resistive	85°C 185°F	3 × 10 ⁴	—	—	—	—	
		22A 30V DC Resistive	40°C 104°F	3 × 10 ⁴	—	—	—	—	
High capacity type	1.5 mm .059 inch	E43028	31A 277V AC General Use	85°C 185°F	3 × 10 ⁴	40023067	31A 250V AC (cosφ=0.8)	85°C 185°F	3 × 10 ⁴
	1.8 mm .071 inch	E43028	33A 277V AC General Use 33A 30V DC Resistive	85°C 185°F 40°C 104°F	3 × 10 ⁴ 3 × 10 ⁴	40023067	33A 250V AC (cosφ=0.8)	85°C 185°F	3 × 10 ⁴

EN/IEC VDE Certified INSULATION CHARACTERISTIC (IEC61810-1)

Item	Characteristic
Clearance/Creepage distance (IEC61810-1)	Min. 5.5mm/5.5mm
Category of protection (IEC61810-1)	RT II
Tracking resistance (IEC60112)	PTI 175
Insulation material group	III a
Over voltage category	III
Rated voltage	250V
Pollution degree	2
Type of insulation (Between contact and coil)	Reinforced insulation
Type of insulation (Between open contacts)	Full disconnection

NOTES

1. For cautions for use, please read “GENERAL APPLICATION GUIDELINES”.
2. Usage, transport and storage conditions
 - 1) Temperature:
 - 40 to +60°C –40 to +140°F (When nominal coil voltage applied)
 - 40 to +85°C –40 to +185°F (When coil holding voltage is 45% to 80% of the nominal coil voltage)
 - 2) Humidity: 5 to 85% RH (Avoid freezing and condensation.) The humidity range varies with the temperature. Use within the range indicated in the graph below.
 - 3) Atmospheric pressure: 86 to 106 kPa

Temperature and humidity range for usage, transport, and storage

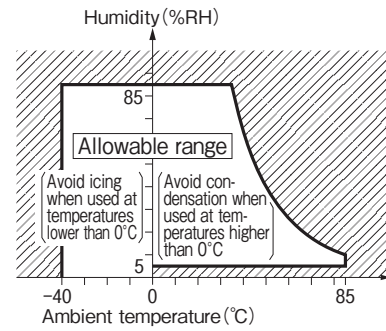
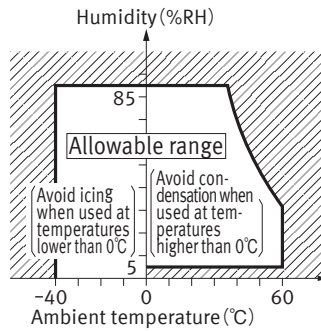

* –40 to +85°C –40 to +185°F (When 45% to 80%V of coil holding voltage)

Please refer to **"the latest product specifications"** when designing your product.

- Requests to customers : <https://industrial.panasonic.com/ac/e/salespolicies/>

GUIDELINES FOR POWER RELAYS AND HIGH-CAPACITY DC CUT OFF RELAYS USAGE

For cautions for use, please read “GUIDELINES FOR RELAY USAGE”.

https://industrial.panasonic.com/ac/e/control/relay/cautions_use/index.jsp

Precautions for Coil Input

■ Long term current carrying

A circuit that will be carrying a current continuously for long periods without relay switching operation. (circuits for emergency lamps, alarm devices and error inspection that, for example, revert only during malfunction and output warnings with form B contacts) Continuous, long-term current to the coil will facilitate deterioration of coil insulation and characteristics due to heating of the coil itself.

For circuits such as these, please use a magnetic-hold type latching relay. If you need to use a single stable relay, use a sealed type relay that is not easily affected by ambient conditions and make a failsafe circuit design that considers the possibility of contact failure or disconnection.

■ DC Coil operating power

Steady state DC current should be applied to the coil. The wave form should be rectangular. If it includes ripple, the ripple factor should be less than 5%.

However, please check with the actual circuit since the electrical characteristics may vary. The rated coil voltage should be applied to the coil and the set/reset pulse time of latching type relay differs for each relays, please refer to the relay's individual specifications.

■ Coil connection

When connecting coils of polarized relays, please check coil polarity (+,-) at the internal connection diagram (Schematic). If any wrong connection is made, it may cause unexpected malfunction, like abnormal heat, fire and so on, and circuit do not work. Avoid impressing voltages to the set coil and reset coil at the same time.

Ambient Environment

● Usage, Transport, and Storage Conditions

During usage, storage, or transportation, avoid locations subjected to direct sunlight and maintain normal temperature, humidity and pressure conditions.

● Temperature/Humidity/Pressure

When transporting or storing relays while they are tube packaged, there are cases the temperature may differ from the allowable range. In this case be sure to check the individual specifications. Also allowable humidity level is influenced by temperature, please check charts shown below and use relays within mentioned conditions. (Allowable temperature values differ for each relays, please refer to the relay's individual specifications.)

1) Temperature:

The tolerance temperature range differs for each relays, please refer to the relay's individual specifications

2) Humidity:

5 to 85 % RH

3) Pressure:

86 to 106 kPa

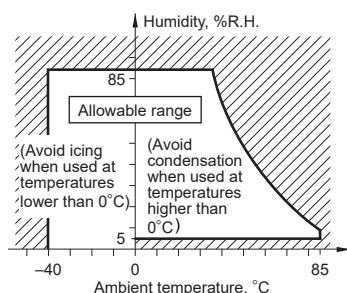

■ Maximum allowable voltage and temperature rise

Proper usage requires that the rated coil voltage be impressed on the coil. Note, however, that if a voltage greater than or equal to the maximum continuous voltage is impressed on the coil, the coil may burn or its layers short due to the temperature rise. Furthermore, do not exceed the usable ambient temperature range listed in the catalog.

■ Operate voltage change due to coil temperature rise (Hot start)

In DC relays, after continuous passage of current in the coil, if the current is turned OFF, then immediately turned ON again, due to the temperature rise in the coil, the pick-up voltage will become somewhat higher. Also, it will be the same as using it in a higher temperature atmosphere. The resistance/temperature relationship for copper wire is about 0.4% for 1°C, and with this ratio the coil resistance increases. That is, in order to operate of the relay, it is necessary that the voltage be higher than the pick-up voltage and the pick-up voltage rises in accordance with the increase in the resistance value. However, for some polarized relays, this rate of change is considerably smaller.

● Dew condensation

Condensation occurs when the ambient temperature drops suddenly from a high temperature and humidity, or the relay is suddenly transferred from a low ambient temperature to a high temperature and humidity. Condensation causes the failures like insulation deterioration, wire disconnection and rust etc. Panasonic Corporation does not guarantee the failures caused by condensation.

The heat conduction by the equipment may accelerate the cooling of device itself, and the condensation may occur.

Please conduct product evaluations in the worst condition of the actual usage. (Special attention should be paid when high temperature heating parts are close to the device. Also please consider the condensation may occur inside of the device.)

● Icing

Condensation or other moisture may freeze on relays when the temperature become lower than 0°C. This icing causes the sticking of movable portion, the operation delay and the contact conduction failure etc. Panasonic Corporation does not guarantee the failures caused by the icing.

The heat conduction by the equipment may accelerate the cooling of relay itself and the icing may occur. Please conduct product evaluations in the worst condition of the actual usage.

● Low temperature and low humidity

The plastic becomes brittle if the switch is exposed to a low temperature, low humidity environment for long periods of time.

● High temperature and high humidity

Storage for extended periods of time (including transportation periods) at high temperature or high humidity levels or in atmospheres with organic gases or sulfide gases may cause a sulfide film or oxide film to form on the surfaces of the contacts and/or it may interfere with the functions. Check out the atmosphere in which the units are to be stored and transported.

GUIDELINES FOR POWER RELAYS AND HIGH-CAPACITY DC CUT OFF RELAYS USAGE

●Package

In terms of the packing format used, make every effort to keep the effects of moisture, organic gases and sulfide gases to the absolute minimum.

●Silicon

When a source of silicone substances (silicone rubber, silicone oil, silicone coating materials and silicone filling materials etc.) is used around the relay, the silicone gas (low molecular siloxane etc.) may be produced.

This silicone gas may penetrate into the inside of the relay. When the relay is kept and used in this condition, silicone compound may adhere to the relay contacts which may cause the contact failure. Do not use any sources of silicone gas around the relay (Including plastic seal types).

●NOx Generation

When relay is used in an atmosphere high in humidity to switch a load which easily produces an arc, the NOx created by the arc and the water absorbed from outside the relay combine to produce nitric acid. This corrodes the internal metal parts and adversely affects operation. Avoid use at an ambient humidity of 85%RH or higher (at 20°C). If use at high humidity is unavoidable, please contact our sales representative.

Others

■Cleaning

- 1) Although the environmentally sealed type relay (plastic sealed type, etc.) can be cleaned, avoid immersing the relay into cold liquid (such as cleaning solvent) immediately after soldering. Doing so may deteriorate the sealing performance.
- 2) Cleaning with the boiling method is recommended(The temperature of cleaning liquid should be 40°C or lower).
Avoid ultrasonic cleaning on relays. Use of ultrasonic cleaning may cause breaks in the coil or slight sticking of the contacts due to ultrasonic energy.

Please refer to "**the latest product specifications**" when designing your product.

•Requests to customers:

<https://industrial.panasonic.com/ac/e/salespolicies/>

Please contact

Panasonic Corporation

Electromechanical Control Business Division

■ 1006, Oaza Kadoma, Kadoma-shi, Osaka 571-8506, Japan
industrial.panasonic.com/ac/e/

Panasonic[®]

©Panasonic Corporation 2019