

KEMET Part Number: SSRH7HS-M07154
(UALSH7SM071540)

KEMET
a YAGEO company

KEMET, SSRH7HS-M, AC Line Filters, Common Mode, 15.4 mH

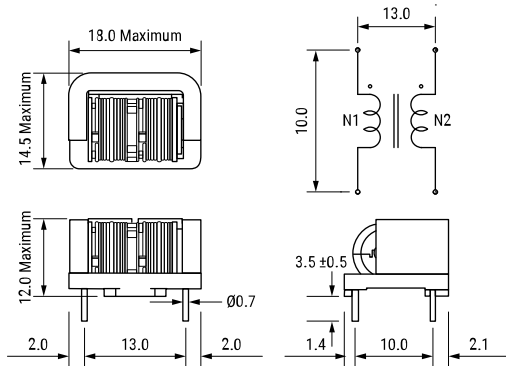

Dimensions

L	18mm MAX
T	14.5mm MAX
H	12mm MAX
LL	3.5mm +/-0.5mm
S	13mm NOM
S1	10mm NOM

Packaging Specifications

Packaging:	Tray
Packaging Quantity:	600
Weight:	5.1 g

General Information

Series:	SSRH7HS-M
Style:	Through-Hole
RoHS:	Yes
Notes:	M07 Lot No.
Miscellaneous:	Temperature Rise Maximum: 50 K

Specifications

Voltage AC:	250 VAC
Inductance:	15.4 mH (10 kHz)
Current:	700 mA
Temperature Range:	-25/+120°C
DC Resistance:	630 mOhms

Statements of suitability for certain applications are based on our knowledge of typical operating conditions for such applications, but are not intended to constitute - and we specifically disclaim - any warranty concerning suitability for a specific customer application or use. This Information is intended for use only by customers who have the requisite experience and capability to determine the correct products for their application. Any technical advice inferred from this Information or otherwise provided by us with reference to the use of our products is given gratis, and we assume no obligation or liability for the advice given or results obtained.

KEMET
a YAGEO company