

**KEMET Part Number: SSHB21HS-R05910**  
(UALSB2SR059100)

**KEMET**  
a YAGEO company

KEMET, SSHB21HS, AC Line Filters, Dual Mode, 91 mH

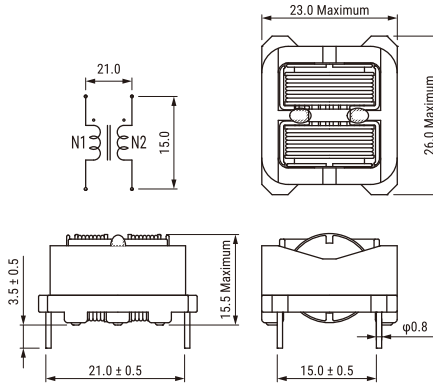

#### Dimensions

<b>L</b>	26mm MAX
<b>T</b>	23mm MAX
<b>H</b>	15.5mm MAX
<b>LL</b>	3.5mm +/-0.5mm
<b>S</b>	21mm +/-0.5mm
<b>S1</b>	15mm NOM

#### Packaging Specifications

<b>Packaging:</b>	Tray
<b>Packaging Quantity:</b>	360
<b>Weight:</b>	14 g

#### General Information

<b>Series:</b>	SSHB21HS
<b>Style:</b>	Through-Hole
<b>RoHS:</b>	Yes
<b>Notes:</b>	Marking: R05 Lot No.
<b>Miscellaneous:</b>	Temperature Rise Maximum: 55 K

#### Specifications

<b>Voltage AC:</b>	250 VAC
<b>Inductance:</b>	91 mH (10 kHz)
<b>Current:</b>	500 mA
<b>Temperature Range:</b>	-25/+120°C
<b>DC Resistance:</b>	1.88 Ohms

Statements of suitability for certain applications are based on our knowledge of typical operating conditions for such applications, but are not intended to constitute - and we specifically disclaim - any warranty concerning suitability for a specific customer application or use. This Information is intended for use only by customers who have the requisite experience and capability to determine the correct products for their application. Any technical advice inferred from this Information or otherwise provided by us with reference to the use of our products is given gratis, and we assume no obligation or liability for the advice given or results obtained.

**KEMET**  
a YAGEO company