



# CQ-2065

## High-Speed Small-Sized Current Sensor

Overview

CQ-2065 is an open-type current sensor using a Hall sensor which outputs the analog voltage proportional to the AC/DC current. Quantum well ultra-thin film InAs (Indium Arsenide) is used as the Hall sensor, which enables the high-accuracy and high-speed current sensing. Simple AI-Shell package with the Hall sensor, magnetic core, and primary conductor realizes the space-saving and high reliability.

Features

- Bidirectional type
- Electrical isolation between the primary conductor and the sensor signal
- 5V single supply operation
- Ratiometric output
- Low variation and low temperature drift of sensitivity and offset voltage
- Low noise output: 2.1mVrms (max.)
- Fast response time: 1μs (typ.)
- Small-sized package, halogen free

Functional Block Diagram

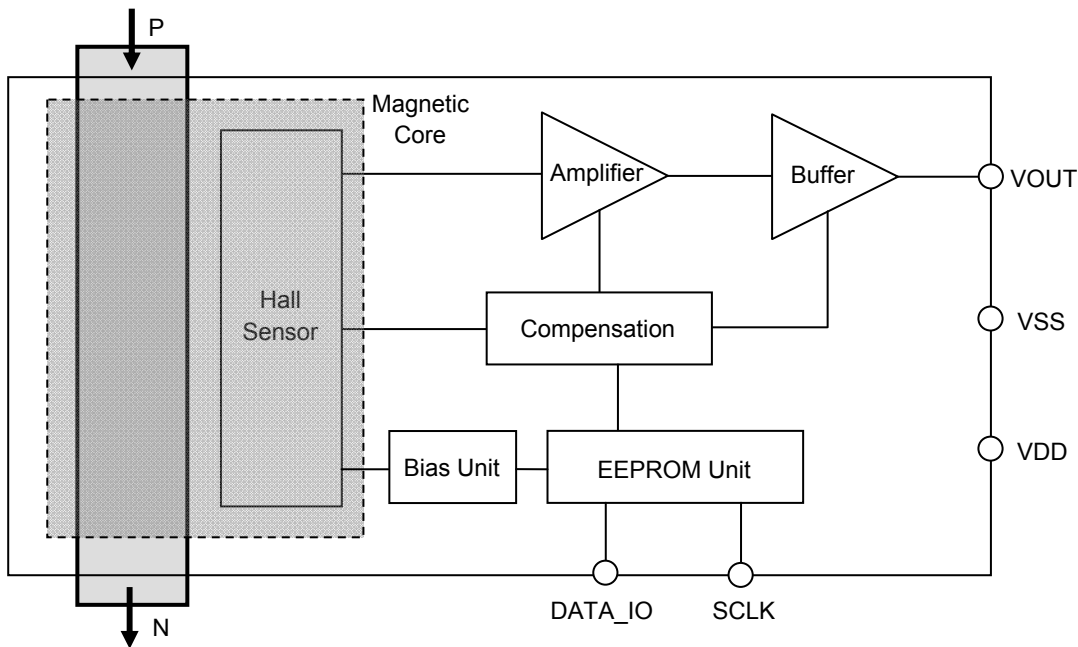

Figure 1. Functional block diagram of CQ-2065

**Circuit Blocks**

**Table 1. Explanation of circuit blocks**

Circuit Block	Function
Hall Sensor	Hall element which detects magnetic flux density generated from the measured current.
Amplifier	Amplifier of Hall element's output.
Buffer	Output buffer with gain. This block outputs the voltage ( $V_{OUT}$ ) proportional to the current applied to the primary conductor.
Compensation	Compensation circuit which adjusts the temperature drifts of sensitivity and offset voltage.
Bias Unit	Drive circuit for Hall element.
EEPROM Unit	Non-volatile memory for setting adjustment parameters. The parameters are adjusted before the shipment.
Magnetic Core	Magnetic core which gathers the magnetic flux density to the Hall element.

**Typical Output Characteristics**

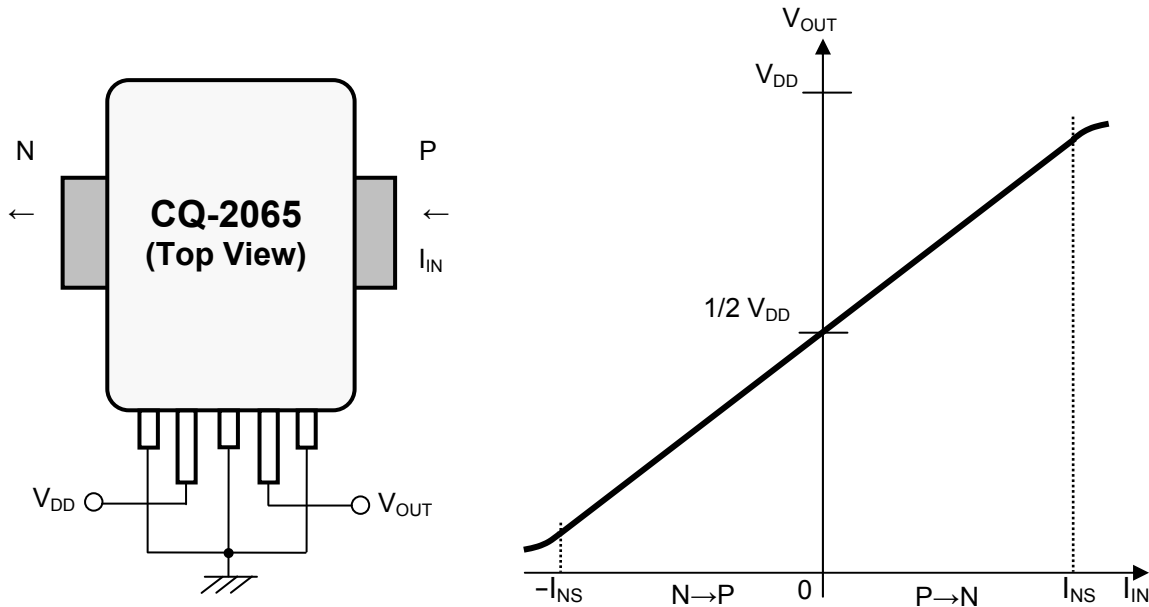
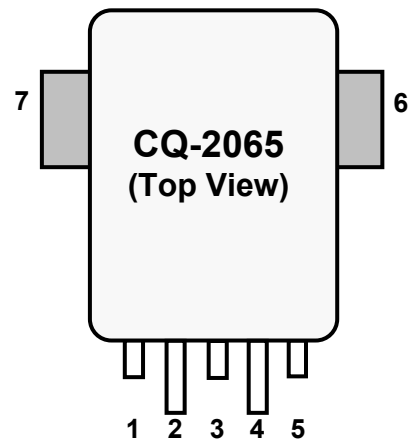

**Figure 2. Typical output characteristics of CQ-2065**

**Pin/Function**

**Table 2. Pin-out description**

No.	Name	I/O	Description
1	DATA_IO	-	Test pin (connect to ground)
2	VDD	-	Power supply pin (5V)
3	VSS	-	Ground pin (0V)
4	VOUT	O	Analog output pin
5	SCLK	-	Test pin (connect to ground)
6	P	I	Primary current pin (+)
7	N	I	Primary current pin (-)



**Figure 3. Pin-out diagram**

**Absolute Maximum Ratings**

**Table 3. Absolute maximum ratings**

Parameter	Symbol	Min.	Max.	Units	Notes
Supply Voltage	V <sub>DD</sub>	-0.3	6	V	VDD
Analog Output Current	I <sub>OUT</sub>	-1	1	mA	VOUT
Storage Temperature	T <sub>stg</sub>	-40	125	°C	

WARNING: Operation at or beyond these limits may result in permanent damage to the device. Normal operation is not guaranteed at these extremes.

**Primary Current Derating Curve**

Conditions: Mounted on the test board complying with the EIA/JEDEC Standards (EIA/JESD51.)

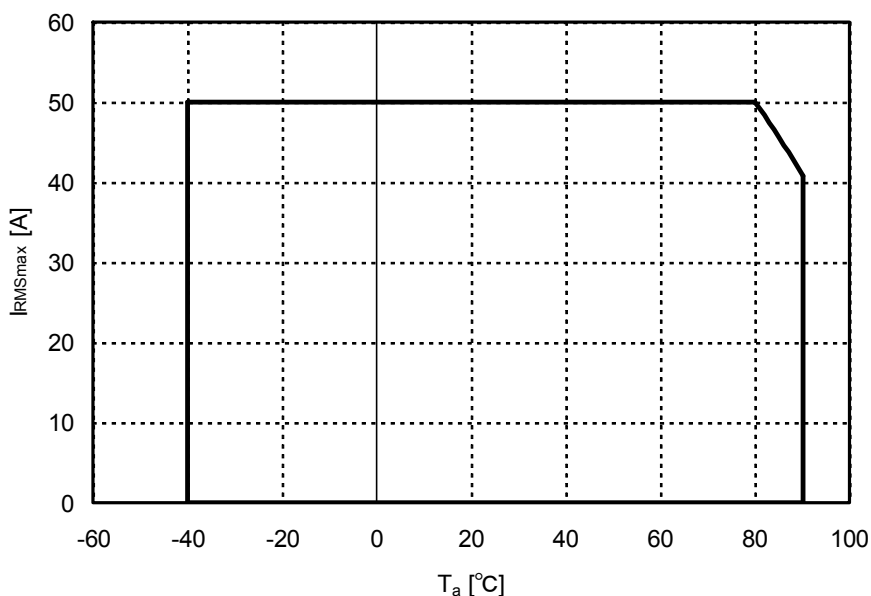

NOTE) Cooling or thermal radiation will improve the derating curve above.

**Figure 4. Primary current derating curve of CQ-2065**

**Recommended Operating Conditions**

**Table 4. Recommended operating conditions**

Parameter	Symbol	Min.	Typ.	Max.	Units	Notes
Supply Voltage	V <sub>DD</sub>	4.5	5.0	5.5	V	
Output Current	I <sub>OUT</sub>	-0.5		0.5	mA	VOUT
Output Load Capacitance	C <sub>L</sub>			100	pF	VOUT
Operating Ambient Temperature	T <sub>a</sub>	-40		90	°C	

NOTE: Electrical characteristics are not guaranteed when operated at or beyond these conditions.

<b>Electrical Characteristics</b>
-----------------------------------

**Table 5. Electrical characteristics**Conditions (unless otherwise specified):  $T_a=25^\circ\text{C}$ ,  $V_{DD}=5\text{V}$ 

Parameter	Symbol	Conditions	Min.	Typ.	Max.	Units
Maximum Primary Current (RMS)	$I_{RMSmax}$		-50		50	A
Current Consumption	$I_{DD}$	No Loads			9	mA
Sensitivity*	$V_h$		24.5	25.0	25.5	mV/A
Offset Voltage*	$V_{of}$	$I_{IN}=0\text{A}$	2.451	2.500	2.549	V
Linear Sensing Range	$I_{NS}$		-85		85	A
Linearity Error*	$\rho$		-1		1	%F.S.
Rise Response Time	$t_r$	$I_{IN} 90\% \rightarrow V_{OUT} 90\%$ $C_L=100\text{pF}$		1		$\mu\text{s}$
Fall Response Time	$t_f$	$I_{IN} 10\% \rightarrow V_{OUT} 10\%$ $C_L=100\text{pF}$		1		$\mu\text{s}$
Bandwidth	$f_T$	-3dB, $C_L=100\text{pF}$		400		kHz
Output Noise**	$V_{Nrms}$				2.1	mVrms
Maximum Temperature Drift of Sensitivity	$V_{h-dmax}$	Variation ratio to $V_h(T_a=35^\circ\text{C})$ $T_a=35\sim 90^\circ\text{C}$		$\pm 1$		%
		Variation ratio to $V_h(T_a=35^\circ\text{C})$ $T_a=-40\sim 35^\circ\text{C}$		$\pm 2$		
Maximum Temperature Drift of Offset voltage	$V_{of-dmax}$	Variation from $V_{of}(T_a=35^\circ\text{C})$ $T_a=-40\sim 90^\circ\text{C}$ , $I_{IN}=0\text{A}$		$\pm 9$		mV
Ratiometricity Error of Sensitivity**	$V_{h-R}$	$V_{DD}=4.5\text{V}\sim 5.5\text{V}$	-1		1	%
Ratiometricity Error of Offset Voltage**	$V_{of-R}$	$V_{DD}=4.5\text{V}\sim 5.5\text{V}$ $I_{IN}=0\text{A}$	-1		1	%
Primary Conductor Resistance	$R_1$			100		$\mu\Omega$
Isolation Voltage**	$V_{INS}$	AC 50/60Hz, 60s	2.5			kV
Isolation Resistance**	$R_{INS}$	DC 1kV	500			M $\Omega$

\* These parameters can drift by the values described in 'Reliability Tests' section over the lifetime of the product.

\*\* These characteristics are guaranteed by design.

## Characteristics Definitions

### (1) Sensitivity $V_h$ [mV/A], offset voltage $V_{of}$ [V]

Sensitivity is defined as the slope of the approximate straight line calculated by the least square method, using the data of  $V_{OUT}$  voltage ( $V_{OUT}$ ) when the primary current ( $I_{IN}$ ) is swept within the range of linear sensing range ( $I_{NS}$ ). Offset voltage is defined as the intercept of the approximate straight line above.

### (2) Linearity error $\rho$ [%F.S.]

Linearity error is defined as the ratio of the maximum error voltage ( $V_d$ ) to the full scale (F.S.), where  $V_d$  is the maximum difference between the  $V_{OUT}$  voltage ( $V_{OUT}$ ) and the approximate straight line calculated in the sensitivity and offset voltage definition. Definition formula is shown in below:

$$\rho = V_d / F.S. \times 100$$

NOTE) Full scale (F.S.) is defined by the multiplication of the linear sensing range and sensitivity (See Figure 5).

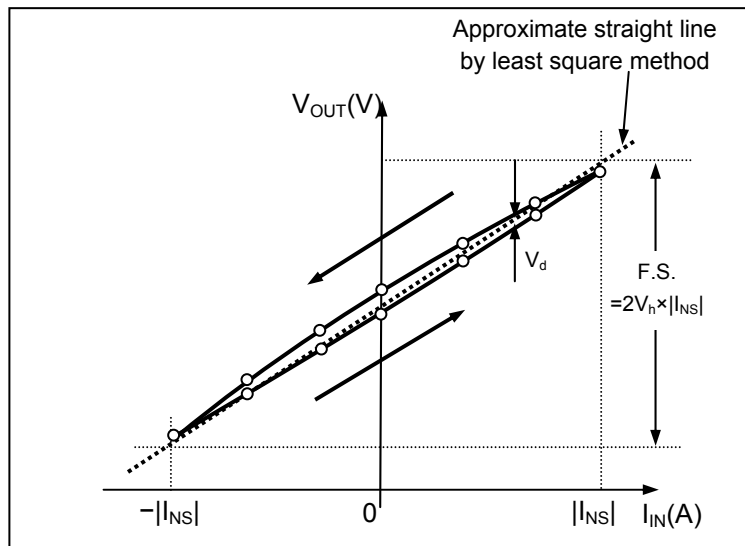

Figure 5. Output characteristics of CQ-2065

### (3) Ratiometric error of sensitivity $V_{h-R}$ [%] and ratiometric error of offset voltage $V_{of-R}$ [%]

Output of CQ-2065 is ratiometric, which means the values of sensitivity ( $V_h$ ) and offset voltage ( $V_{of}$ ) are proportional to the supply voltage ( $V_{DD}$ ). Ratiometric error is defined as the difference between the  $V_h$  (or  $V_{of}$ ) and ideal  $V_h$  (or  $V_{of}$ ) when the  $V_{DD}$  is changed from 5.0V to  $V_{DD1}$  ( $4.5V < V_{DD1} < 5.5V$ ). Definition formula is shown in below:

$$V_{h-R} = 100 \times \{ (V_h(V_{DD} = V_{DD1}) / V_h(V_{DD} = 5V)) - (V_{DD1} / 5) \} / (V_{DD1} / 5)$$

$$V_{of-R} = 100 \times \{ (V_{of}(V_{DD} = V_{DD1}) / V_{of}(V_{DD} = 5V)) - (V_{DD1} / 5) \} / (V_{DD1} / 5)$$

### (4) Temperature drift of sensitivity $V_{h-d}$ [%]

Temperature drift of sensitivity is defined as the drift ratio of the sensitivity ( $V_h$ ) at  $T_a = T_{a1}$  ( $-40^\circ\text{C} < T_{a1} < 90^\circ\text{C}$ ) to the  $V_h$  at  $T_a = 35^\circ\text{C}$ , and calculated from the formula below:

$$V_{h-d} = 100 \times (V_h(T_{a1}) / V_h(35^\circ\text{C}) - 1)$$

Maximum temperature drift of sensitivity ( $V_{h-dmax}$ ) is defined as the maximum value of  $|V_{h-d}|$  through the defined temperature range.

Reference data of the temperature drift of sensitivity of CQ-2065 is shown in Figure 6.

**(5) Temperature drift of offset voltage  $V_{of-d}$  [mV]**

Temperature drift of offset voltage is defined as the drift value between the offset voltage ( $V_{of}$ ) at  $T_a=T_{a1}$  ( $-40^{\circ}\text{C}<T_{a1}<90^{\circ}\text{C}$ ) and the  $V_{of}$  at  $T_a=35^{\circ}\text{C}$ , and calculated from the formula below:

$$V_{of-d} = V_{of}(T_a = T_{a1}) - V_{of}(T_a = 35^{\circ}\text{C})$$

Maximum temperature drift of offset voltage ( $V_{of-dmax}$ ) is defined as the maximum value of  $|V_{of-d}|$  through the defined temperature range.

Reference data of the temperature drift of offset voltage of CQ-2065 is shown in Figure 7.

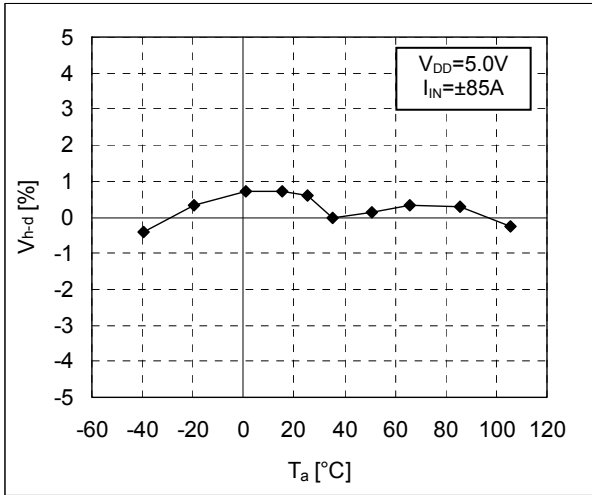

**Figure 6. Temperature drift of sensitivity of CQ-2065 (for reference, n=1)**

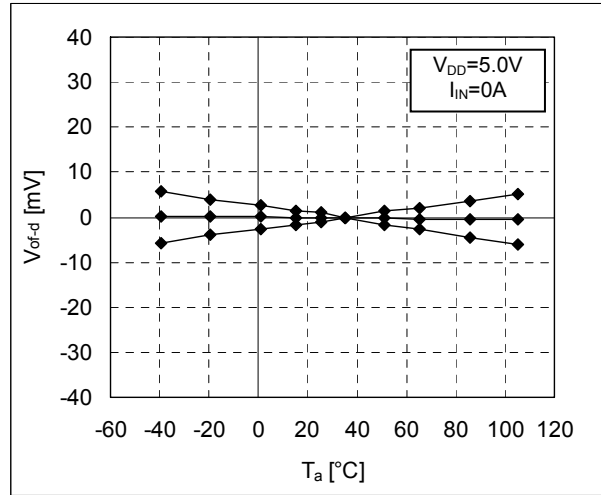

**Figure 7. Temperature drift of offset voltage of CQ-2065 (for reference, n=3)**

**(6) Rise response time  $t_r$  [ $\mu\text{s}$ ] and fall response time  $t_f$  [ $\mu\text{s}$ ]**

Rise response time (or fall response time) is defined as the time delay from the 90% (or 10%) of input primary current ( $I_{IN}$ ) to the 90% (or 10%) of the  $V_{OUT}$  voltage ( $V_{OUT}$ ) under the pulse input of primary current (see Figure 8.)

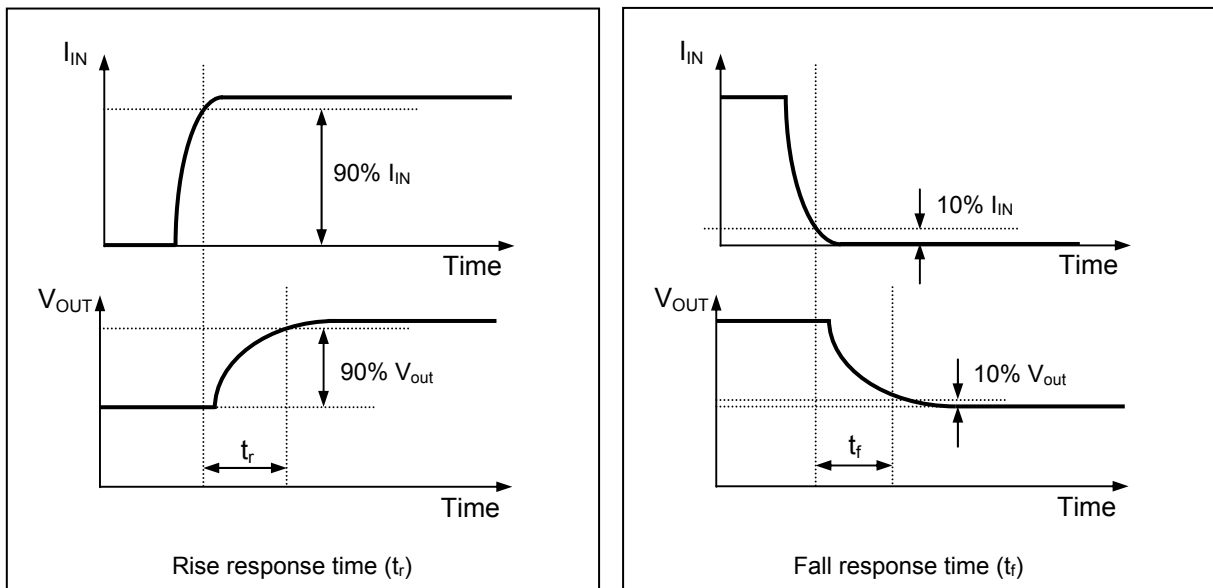

**Figure 8. Definition of response time**

**Package Dimensions**

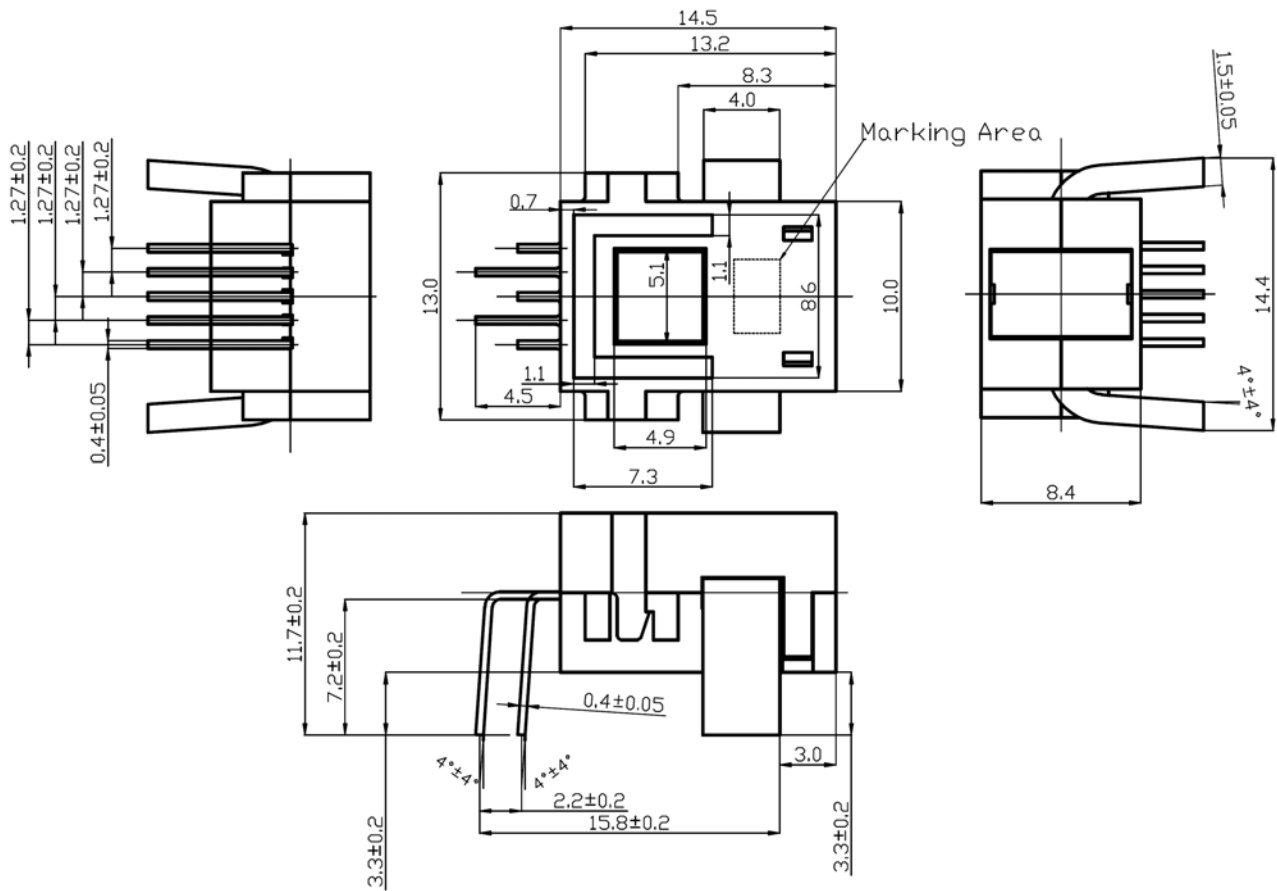

Unit:mm

Note1) The tolerances of dimensions without any mention are ±0.1mm.

Terminals: Cu  
 Plating for Terminals: Sn (100%)  
 RoHS compliant, halogen free

**Figure 9. Package outline**

Recommended Land Pattern (Reference Only)

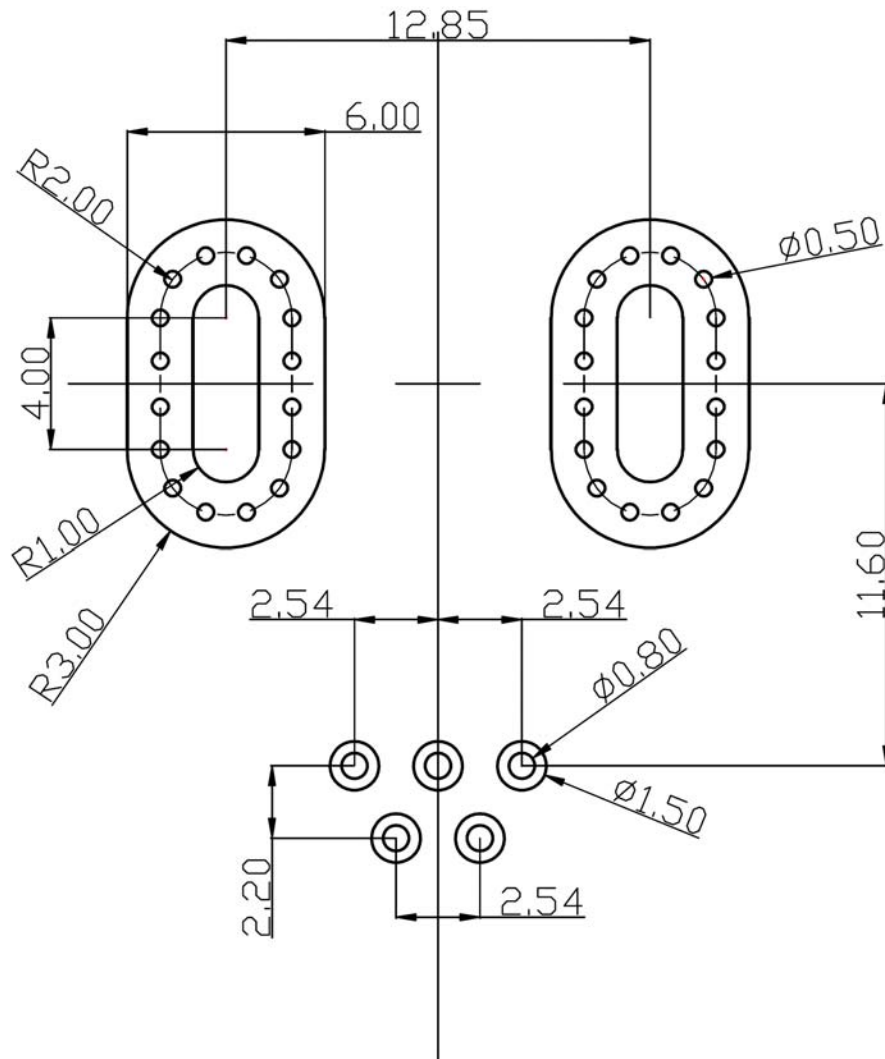

Unit:mm

**Figure 10. Recommended land pattern of CQ-2065**

Note) If 2 or more trace layers are used as the current path, please make enough number of through-holes to flow current between the trace layers.



**Application Circuits**

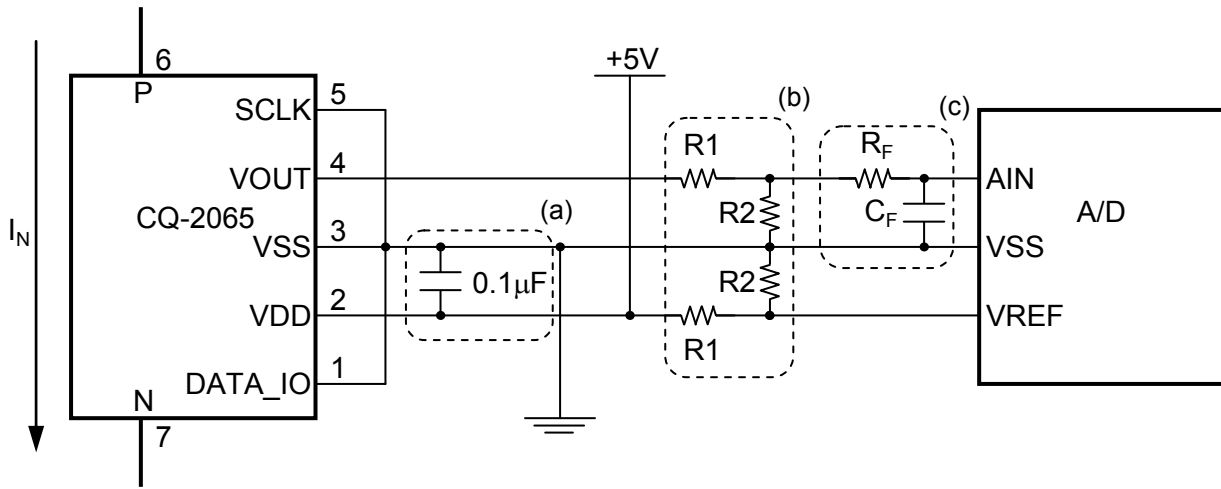

- (a) 0.1µF bypass capacitor should be placed near by the CQ-2065
- (b) Ratiometric output of CQ-2065 enables an A/D system to improve the A/D conversion error caused by the fluctuation of supply voltage. This is achieved by making the supply voltage of CQ-2065 and the reference voltage of A/D converter common.  
Voltage dividers (R1 and R2) are required if the reference voltage of A/D converter is less than +5V.  
For example, if the reference voltage of A/D converter is +3.3V which is its supply voltage level, R1=20kΩ , R2=39kΩ are recommended. If the reference voltage of A/D converter is different from its supply voltage level, one more voltage divider is required.
- (c) Add a low-pass filter if it is necessary.

**Figure 11. Recommended circuits when using A/D converter**

**Markings**

Production information is printed on the package surface by laser marking. Markings consist of 12 characters (6 characters × 2 lines).

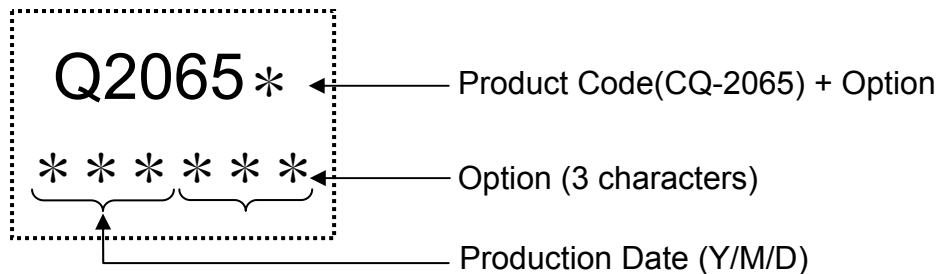

**Figure 12. Markings of CQ-2065**

**Table 6. Production date code table**

Last Number of Year		Month		Day	
Character	Number	Character	Month	Character	Day
0	0	C	Jan.	1	1
1	1	D	Feb.	2	2
2	2	E	Mar.	3	3
3	3	F	Apr.	4	4
4	4	G	May.	5	5
5	5	H	Jun.	6	6
6	6	J	Jul.	7	7
7	7	K	Aug.	8	8
8	8	L	Sep.	9	9
9	9	M	Oct.	0	10
		N	Nov.	A	11
		P	Dec.	B	12
				C	13
				D	14
				E	15
				F	16
				G	17
				H	18
				J	19
				K	20
				L	21
				N	22
				P	23
				R	24
				S	25
				T	26
				U	27
				V	28
				W	29
				X	30
				Y	31

<b>Reliability Tests</b>
--------------------------

**Table 7. Test parameters and conditions of reliability test**

No.	Test Parameter	Test Conditions	n	Test Time
1	High Humidity Storage Test	【JEITA EIAJ ED-4701 102】 T <sub>a</sub> =85°C, 85%RH, continuous operation	22	1000h
2	High Temperature Bias Test	【JEITA EIAJ ED-4701 101】 T <sub>a</sub> =125°C, continuous operation	22	1000h
3	High Temperature Storage Test	【JEITA EIAJ ED-4701 201】 T <sub>a</sub> =150°C	22	1000h
4	Low Temperature Storage Test	【JEITA EIAJ ED-4701 202】 T <sub>a</sub> = -55°C	22	1000h
5	Heat Cycle Test	【JEITA EIAJ ED-4701 105】 -40°C ↔ 25°C ↔ 125°C 30min. ↔ 5min. ↔ 30min. Tested in vapor phase	22	100 cycles
6	Vibration Test	【JEITA EIAJ ED-4701 403】 Vibration frequency: 10~55Hz (1min.) Vibration amplitude: 1.5mm (x, y, z directions)	5	2h for each direction

Tested samples are pretreated as below before each reliability test:

Desiccation: 125°C /24h → Moisture Absorption: 85°C/85%RH/168h → Flow: 1 time (260°C, 10s)

Criteria:

Products whose drifts before and after the reliability tests do not exceed the values below are considered to be in spec.

Sensitivity V <sub>n</sub> (T <sub>a</sub> =25°C)	: Within ±1.5%
Offset Voltage V <sub>of</sub> (T <sub>a</sub> =25°C)	: Within ±100mV
Linearity ρ (T <sub>a</sub> =25°C)	: Within ±1%

<b>Precautions</b>
--------------------

## &lt;Storage Environment&gt;

Products should be stored at an appropriate temperature and humidity (5 to 35°C, 40 to 85%RH).  
Keep products away from chlorine and corrosive gas.

## &lt;Long-term Storage&gt;

Long-term storage may result in poor lead solderability and degraded electrical performance even under proper conditions. For those parts, which stored long-term shall be check solderability before it is used.  
For storage longer than 2 years, it is recommended to store in nitrogen atmosphere. Oxygen of atmosphere oxidizes leads of products and lead solderability get worse.

## &lt;Other precautions&gt;

- 1) This product should not be used under the environment with corrosive gas including chlorine or sulfur.
- 2) This product is lead (Pb) free. All leads are plated with 100% tin. Do not store this product alone in high temperature and high humidity environment. Moreover, this product should be mounted on substrate within six months after delivery.
- 3) This product is damaged when it is used on the following conditions:
  - Supply voltage is applied in the opposite way.
  - Overvoltage which is larger than the value indicated in the specification.
- 4) This product will be damaged if it is used for a long time with the current (effective current) which exceeds the current rating. Careful attention must be paid so that maximum effective current is smaller than current rating.
- 5) Since magnetic cores are fragile parts, do not use the fallen products.
- 6) The characteristic can change by the influences of nearby current and magnetic field. Please make sure of the mounting position.

As this product contains gallium arsenide, observe the following procedures for safety.

- 1) Do not alter the form of this product into a gas, powder, liquid, through burning, crushing, or chemical processing.
- 2) Observe laws and company regulations when discarding this product.

## IMPORTANT NOTICE

0. Asahi Kasei Microdevices Corporation (“AKM”) reserves the right to make changes to the information contained in this document without notice. When you consider any use or application of AKM product stipulated in this document (“Product”), please make inquiries the sales office of AKM or authorized distributors as to current status of the Products.
1. All information included in this document are provided only to illustrate the operation and application examples of AKM Products. AKM neither makes warranties or representations with respect to the accuracy or completeness of the information contained in this document nor grants any license to any intellectual property rights or any other rights of AKM or any third party with respect to the information in this document. You are fully responsible for use of such information contained in this document in your product design or applications. **AKM ASSUMES NO LIABILITY FOR ANY LOSSES INCURRED BY YOU OR THIRD PARTIES ARISING FROM THE USE OF SUCH INFORMATION IN YOUR PRODUCT DESIGN OR APPLICATIONS.**
2. The Product is neither intended nor warranted for use in equipment or systems that require extraordinarily high levels of quality and/or reliability and/or a malfunction or failure of which may cause loss of human life, bodily injury, serious property damage or serious public impact, including but not limited to, equipment used in nuclear facilities, equipment used in the aerospace industry, medical equipment, equipment used for automobiles, trains, ships and other transportation, traffic signaling equipment, equipment used to control combustions or explosions, safety devices, elevators and escalators, devices related to electric power, and equipment used in finance-related fields. Do not use Product for the above use unless specifically agreed by AKM in writing.
3. Though AKM works continually to improve the Product’s quality and reliability, you are responsible for complying with safety standards and for providing adequate designs and safeguards for your hardware, software and systems which minimize risk and avoid situations in which a malfunction or failure of the Product could cause loss of human life, bodily injury or damage to property, including data loss or corruption.
4. Do not use or otherwise make available the Product or related technology or any information contained in this document for any military purposes, including without limitation, for the design, development, use, stockpiling or manufacturing of nuclear, chemical, or biological weapons or missile technology products (mass destruction weapons). When exporting the Products or related technology or any information contained in this document, you should comply with the applicable export control laws and regulations and follow the procedures required by such laws and regulations. The Products and related technology may not be used for or incorporated into any products or systems whose manufacture, use, or sale is prohibited under any applicable domestic or foreign laws or regulations.
5. Please contact AKM sales representative for details as to environmental matters such as the RoHS compatibility of the Product. Please use the Product in compliance with all applicable laws and regulations that regulate the inclusion or use of controlled substances, including without limitation, the EU RoHS Directive. AKM assumes no liability for damages or losses occurring as a result of noncompliance with applicable laws and regulations.
6. Resale of the Product with provisions different from the statement and/or technical features set forth in this document shall immediately void any warranty granted by AKM for the Product and shall not create or extend in any manner whatsoever, any liability of AKM.
7. This document may not be reproduced or duplicated, in any form, in whole or in part, without prior written consent of AKM.